



addressed herein and apply to both existing outfalls. This technical report draws upon the methods and findings of two supporting technical studies: *Tidal Hydraulics of Batiquitos Lagoon Relevant to Discharges from New Storm Water Infrastructure Improvements along North Coast Highway 101 within the City of Encinitas* by Jenkins (2020) and water quality first flush memorandum by Q3 (2020). Both studies are appended in their entirety as Appendices A and B, respectively, and referenced in this report where appropriate.

## LOCAL AREA

Watershed hydrology for the local area (La Costa Avenue, N. Coast Highway 101 intersection) was recently analyzed by Hale Engineering as part of the Encinitas Beach Resort development. The new Resort is currently under construction and is located immediately west of N. Coast Highway 101, at the westerly terminus of La Costa Avenue. Hale Engineering prepared a drainage study, *Coast Highway 101 Widening* (Hale July 2017), in support of the Resort development. The study includes an analysis of 100-year Rational Method peak flow discharge into the Batiquitos Lagoon at the east-101 outfall under existing and post-development (Beach Resort) conditions.

Table 1 below summarizes Rational Method peak flow discharge at the east-101 outfall under pre-development conditions, which correlates with the Beach Resort post-development condition. Results for the 100-year flow rate have been extracted from the *Coast Highway 101 Widening* drainage study (Hale, July 2017), which includes 100-year peak flow at each sub-basin tributary to the east-101 outfall. The 100-year tabulated peak flows in Table 1 below are a summation of these individual sub-basin results and thus conservative.

Tabulated results for the 2-, 5-, 10-, and 50-year storm events have been derived using 6-hour rainfall depth ratios for the respective storm events. This approach is warranted based on the Rational Method used to determine 100-year peak flow and the order-of-magnitude comparison approach.

**Table 1 East-101 Outfall Peak Flow Discharge (pre-development)**

Outfall: 24" RCP	Q2 (cfs)	Q5 (cfs)	Q10 (cfs)	Q50 (cfs)	Q100 (cfs)
East-101 Outfall (post-Beach Resort)	7.5	8.8	10.0	12.6	15.7
<i>All tabulated results are intended to provide an order of magnitude comparison of peak flow discharge into the Batiquitos Lagoon to help determine significance.</i>					

## PROJECT AREA

Watershed hydrology for the project area has been developed by Q3 using a rain-on-grid approach and documented in their development of a regional Master Plan of Drainage for the Leucadia and Old Encinitas watershed areas. This analysis focused on the 100-year storm event to identify storm drain deficiencies throughout the watershed.

MBI has built upon this modeling to develop 2-, 5-, 10-, and 50-year peak flow discharge at the existing outfalls, including an analysis of the proposed diversion structure. The east-101 outfall is the focal point of this memo, as discharge occurs within a portion of the Lagoon not immediately adjacent to the Pacific Ocean; as is the case with the west-101 outfall. The rain on grid modeling approach is inherently more indicative of actual rainfall and discharge, as compared to peak flows generated using the traditional Rational Method approach widely accepted by local, state, and federal agencies.

Table 2, Table 3, and Table 4 summarize the peak flow discharge, maximum velocity and total volume at the east-101 outfall under post-development conditions. The proposed diversion structure is included in Table 2 below and characterizes project-site runoff contributed to the east-101 outfall under post-development conditions. The project site does not contribute flow to the east-101 outfall during the 2-year storm event, thus Q2 at the diversion structure is zero. The peak flow discharge results (Table 2), when compared to Table 1, provide an order of magnitude comparison of peak flow discharge at the east-101 outfall. Refer to the Water Quality section below for further discussion.

**Table 2 East-101 Outfall Peak Flow Discharge (post-development)**

Outfall: 24" RCP	Q2 (cfs)	Q5 (cfs)	Q10 (cfs)	Q50 (cfs)	Q100 (cfs)
East-101 Outfall	1.3	9.9	27.5	45.9	48.2
Diversion Structure	0.0	9.4	26.9	45.2	47.1

*The diversion structure is included to show zero discharge from the project site at the east-101 outfall during Q2 peak flow.*

**Table 3 East-101 Outfall Maximum Velocity (post-development)**

Outfall: 24" RCP	V2 (ft/s)	V5 (ft/s)	V10 (ft/s)	V50 (ft/s)	V100 (ft/s)
East-101 Outfall	4.3	8.5	11.8	16.1	16.8

*These values represent total volume at the outfall, including contributions from the project site, Beach Resort, and adjacent intersection.*

**Table 4 East-101 Outfall Total Volume (post-development)**

Outfall: 24" RCP	Vol2 (ft <sup>3</sup> )	Vol5 (ft <sup>3</sup> )	Vol10 (ft <sup>3</sup> )	Vol50 (ft <sup>3</sup> )	Vol100 (ft <sup>3</sup> )
East-101 Outfall	7,966	19,470	62,820	218,017	295,455
<i>These values represent total volume at the outfall, including contributions from the project site, Beach Resort, and adjacent intersection.</i>					

The tabulated post-development reduction in 2-year peak flow can be attributed the differing modeling approaches and associated study areas. During the 2-year storm event, the project area will not contribute flow to the east-101 outfall. During the 5-year storm event, the project area will start to contribute flow to the east-101 outfall. As such, despite the tabulated peak flow results herein, no change is anticipated to the quantity or quality of flow discharged at the east-101 outfall as a result of the project during events less than the 5-year storm.

The post-development increase in peak flow during larger storm events can be attributed to the reduced flooding achieved throughout the project watershed as a result of the proposed improvements. New impervious area is not proposed, thus an increase in watershed *runoff* is not anticipated. A reduction in at-grade ponding and flooding within the project corridor creates additional discharge at the outfall. Improvements provide some additional sub-grade storage via the new storm drain, but ultimately the reduction in flooding is accompanied with an increase in discharge.

## WATER QUALITY

Results from Q3's water quality first flush memorandum, Appendix B herein, indicate the project area does not contribute discharge to the east-101 outfall during the 85<sup>th</sup> percentile water quality storm event. This is significant when determining a potential impact to the receiving water at the east-101 outfall under pre- and post-development conditions. As documented in Tables 1 and 2 in this memorandum, the east-101 does experience some discharge during the 85<sup>th</sup> percentile storm event. This discharge is from the local intersection and improvements associated with the Beach Resort.

Under post development conditions, runoff from local area (the intersection of N. Coast Highway 101 and La Costa Avenue at the Encinitas Beach Resort), including the local 85<sup>th</sup> percentile, will continue to discharge to the Lagoon at the east-101 outfall, consistent with pre-development conditions.

The east-101 outfall contains energy dissipation in the form of a new Regional Standard D-41A Concrete Energy Dissipator. This new structure is currently being installed as part of the intersection improvements associated with the new Beach Resort. This structure is adequate to mitigate 100-year post-development flows (~16 ft/s) to acceptable velocities for erosion protection.

Discharge at the west-101 outfall will not be increased as a result of the project based on existing capacity limitations associated with the 18" and 24" RCP. As such, proposed improvements will not increase

erosion risk. The west-101 discharge area is currently impacted by construction of the Beach Resort. It is assumed adequate erosion control will be included at the termination of that development and that on-site post-development treatment control BMPs will be installed to treat 85<sup>th</sup> percentile runoff.

## CONCLUSIONS

The proposed storm drain improvements, green-street design, and diversion structure have been designed to improve flooding along N. Coast Highway 101 and provide water quality benefit to the receiving water, as compared to pre-development conditions.

San Diego is subjected to annual rainfall on the order of 12-inches per year. A majority of runoff-producing storm events occur within the 2- to 5-year storm event range. The new diversion structure will prevent Project Area runoff from discharging at the east-101 outfall for storms up to the 5-year event. As such, water quality and quantity discharge at the east-101 outfall will remain a function of the Local Area and not be impacted by the proposed improvements for storms up to the 5-year event, as compared to pre-development conditions.

During the 5-year storm event, discharge at the east-101 outfall is expected to be consistent with pre-development conditions. During larger storm events, discharge quantity at the east-101 outfall is increased as a result of reduced flooding along N. Coast Highway 101. At the east-101 outfall, water quality is not expected to change significantly under large storm events based on the first flush always diverting to the west-101 outfall.

Peak flow discharge and water quality at the west-101 outfall is not expected to be significantly impacted as a result of the proposed improvements. The new diversion structure has been designed to prevent an increase in quantity based on existing pipe capacity. Water quality at the west-101 outfall is expected to improve under post-development conditions based on the proposed green street design implemented throughout the Project Area.

## CEQA THRESHOLD OF SIGNIFICANCE

### **Would the Project:**

#### **1. Result in a substantial degradation of receiving water quality during construction activities?**

No, the project will comply with all local, state, and federal requirements for discharging storm water during construction. A project specific Storm Water Pollution Prevent Plan (SWPPP) will be developed by a Qualified SWPPP Developer (QSD) and processed with the Regional Board. A Qualified SWPPP Practitioner (QSP) will perform weekly inspections to ensure compliance with the Statewide Construction General Permit.

#### **2. Propose a land use or an on-site activity that would substantially degrade receiving water quality?**

No, the project will not result in a land use change that would substantially degrade receiving water quality at the east-101 outfall, (Appendix A, Abstract and Sections 5 & 6). Proposed improvements result in reduced impervious cover, as compared to pre-development conditions. Additionally, proposed

improvements include new BMP's for street flow treatment in a watershed absent of current treatment. The proposed project is expected to result in improved water quality, when considering pollutant removal associated with the new BMPs, relative to pre-development conditions.

**3. Substantially increase any pollutant for which a tributary water body is listed on the Clean Water Act Section 303(d) list?**

No, the project will not increase any 303(d)-listed pollutants for the receiving water body at the east-101 outfall, the Batiquitos Lagoon, (Appendix A, Abstract and Sections 5 & 6). The Lagoon is impaired for toxicity. Sources of this pollutant type include contaminants from residential and commercial areas, industrial activities, construction, streets and parking lots. Proposed improvements do not include activities that will increase any of these pollutant types. Rather, proposed improvements are anticipated to provide a water quality benefit through new green-street design that includes multiple biofiltration areas, dispersion areas, and increased disconnection of street flow runoff, prior to discharging to the Lagoon. At the west-101 outfall, two existing detention basins provide additional treatment prior to the discharge into the Lagoon. All project site 85<sup>th</sup> percentile runoff is directed to the west-101 outfall via the new diversion structure. The east-101 outfall only receives 85<sup>th</sup> percentile runoff from the local intersection, consistent with pre-development conditions.

**4. Substantially degrade surface water quality within wetland, fresh, marine, or recreational waters?**

No, the project will not degrade surface water quality within the Batiquitos Lagoon at the east-101 outfall, (Appendix A, Abstract and Sections 5 & 6). Runoff from project area 85<sup>th</sup> percentile storm event is not directed to the east-101 outfall (Q3, Appendix B). Proposed BMPs located throughout the Project Area will provide first flush treatment in multiple locations. These BMPs are anticipated to reduce discharged pollutants commonly associated with the first flush at the west-101 outfall, as compared to pre-development conditions, which are void of any pre-treatment devices. The proposed project will obtain coverage and comply with requirements outlined in the National Pollutant Discharge Elimination System, which governs water pollution by regulating point sources that discharge pollutants to prevent the degradation of receiving waters.

**5. Have a substantial adverse effect on state or federally protected wetlands (including, but not limited to, marsh, vernal pool, coastal, etc.) through direct removal, filling, hydrological interruption, or other means?**

No, the project will not result in any adverse effect to the receiving water body, the Batiquitos Lagoon. Proposed improvements do not include any removal, filling, or hydrological interruption to the project-site tributary area, (Appendix A, Abstract and Sections 5 & 6). A D-41A concrete energy dissipator will be installed at the east-101 outfall as part of the Beach Resort development and is sized to prevent erosive velocities under post-development conditions.

**6. Violate any water quality standards or waste discharge requirements or otherwise substantially degrade surface or groundwater quality?**

No, the project will not violate any water quality standards, waste discharge requirements, or otherwise substantially degrade surface or groundwater quality. Newly proposed green street design elements, such as biofiltration basins, dispersion areas, and landscape will provide first-flush treatment in a portion of the watershed where treatment is currently not provided. The project site is not located within the Batiquitos Lagoon Valley Groundwater Basin, as documented by the County of San Diego.

**7. Substantially decrease groundwater supplies or interfere substantially with groundwater recharge such that the project may impede sustainable groundwater management of the basin?**

No, the project will not result in any measurable impact to groundwater supplies or interfere with groundwater recharge. Proposed improvements do not include new discharge locations, the two existing outfalls will remain. These two outfalls and the entire project footprint and tributary area are not located within the Batiquitos Lagoon Valley Groundwater Basin and thus will have no measurable impact on groundwater management.

**8. Substantially alter the existing drainage pattern of the site or area, including through the alteration of the course of a stream or river or through the addition of impervious surfaces, in a manner which would:**

- a. result in substantial erosion or siltation on- or off-site;
- b. substantially increase the rate or amount of surface runoff in a manner which would result in flooding on- or offsite;
- c. create or contribute runoff water which would exceed the capacity of existing or planned stormwater drainage systems or provide substantial additional sources of polluted runoff;
- d. redirect or impede flows;

No, proposed improvements will not substantially alter the risk of erosion or siltation. Erosion is not a concern throughout a majority of the Project Area based on impervious cover (cf. Tidal Hydraulics Appendix, Section 6). A D-41A concrete energy dissipater is proposed at the east-101 outfall as part of the Beach Resort development and represents an existing condition for the proposed project. This D-41A is sized to mitigate post-development peak flow velocity.

No, proposed improvements do not include any new impervious area that might contribute to increased runoff. Proposed improvements reduce Project Area on-site flooding through new storm drain infrastructure. Peak flow *discharge* during large storm events will increase at the east-101 outfall; however, appropriate energy dissipaters are currently being installed to mitigate erosion as part of the new Beach Resort development. Project site first flush (85<sup>th</sup> percentile) is diverted to the west-101 outfall after undergoing pre-treatment via the new green street BMPs. This runoff is further treated by two existing detention basins at the west-101 outfall, prior to discharge into the Lagoon. No change to peak flow discharge will occur at the west-101 outfall.

No, the new diversion structure has been designed to accommodate the existing capacities of the two outfalls. There are no new additional sources of polluted runoff, improvements reduce impervious cover and a land-use change is not proposed. New greens street BMPs will provide first-flush treatment in a watershed that currently has no pre-treatment. The existing detention basins located at the west-101 outfall will continue to provide “end of pipe” treatment prior to discharge into the Lagoon. The project area does not contribute any discharge to the east-101 outfall during the 85<sup>th</sup> percentile storm event.

No, the proposed improvements will not substantially impede flows. New storm drain infrastructure will improve flow conveyance, as compared to pre-development conditions, and will result in reduced on-site ponding and flooding along N. Coast Highway 101. The redirection of surface ponding to sub-grade pipe conveyance is a benefit that abates localized flooding to properties and streets in Leucadia while not adversely affecting the receiving waters or other public or private properties, (Appendix A, Abstract and Sections 5 & 6).

**9. In flood hazard, tsunami, or seiche zones, risk release of pollutants due to project inundation?**

No, the project development footprint is not located in tsunami or seiche zones, as shown on the Tsunami Inundation Map for Emergency Planning (State of CA, County of San Diego, June 2009). N. Coast Highway 101 south of La Costa Avenue is prone to localized flooding during frequent storm events. Proposed improvements will reduce local flooding along N. Coast Highway 101 and improve water quality runoff through new storm drain infrastructure and green street design. The proposed green street BMPs have been designed and located to provide first-flush treatment from small tributary areas via filtration. Dispersion areas and new landscape will facilitate infiltration of first-flush runoff. Biofiltration areas will include sub-drains and overflow risers to control flow. These BMPs are not anticipated to release pollutants.

Storm water discharge at the existing east-101 and west-101 outfalls is expected to be cleaner under post-development conditions when considering the proposed green street BMPs throughout the watershed and the lack of first-flush treatment under pre-development conditions. The proposed diversion structure has been designed to prevent Project Area 85<sup>th</sup> percentile discharge at the east-101 outfall (Q3, Appendix B). As such, the east-101 outfall will not be impacted by proposed improvements during the 85<sup>th</sup> percentile runoff event. Storm events up to the 5-year will be diverted to the west-101 outfall, which ultimately enters the Lagoon adjacent to the Pacific Ocean. By locating new green street design throughout the project area, there is less concentrated pollutant loading in storm water as discharge occurs into the existing basins immediately downstream of the west-101 outfall.

**10. Conflict with or obstruct implementation of a water quality control plan or sustainable groundwater management plan?**

No, proposed improvements are not expected to obstruct implementation of any current or future water quality control plans developed for the Batiquitos Lagoon. Discharge at the east-101 outfall remains unchanged for storm events typical of pollutant storm water transport. Discharge at the west-101 outfall now includes first-flush treatment periodically throughout the Project Area to reduce concentrated pollutant loading at the outfall. The existing outfalls and proposed project footprint are not located within the Batiquitos Lagoon Valley Groundwater Basin and thus will not impact groundwater management.

The Batiquitos Lagoon has been designated as a State Marine Park by the California Legislature and as an Ecological Reserve by the California Department of Fish and Game. The Batiquitos Lagoon was listed as impaired by the San Diego Regional Board in the 2014 and 2016 Integrated Report (303(d) List/305(b) Report) for toxicity. Compliance with the Construction General permit will address and mitigate any potential toxicity concerns during construction, all disturbed areas will be monitored prior to, during, and after all storm events.

The City of Encinitas is listed as a Co-Permittee under the current NPDES Permit. This permit regulates post-development discharge into municipal separate storm sewer systems (MS4s) and does not allow projects to cause or contribute to the exceedance of water quality standards. To meet NPDES requirements, projects must have BMPs designed to the respective criteria (page 89 of the permit, Sections 3.a, 3.b, and 3.c). The proposed project will comply with the requirements outlined in the NPDES Permit through installation of Site Design, Source Control and Treatment Control BMPs. These new BMP's



include reduced impervious cover, dispersion areas, new landscape areas for disconnecting roadway runoff, and biofiltration basins. These proposed BMPs are located throughout the project area to further improve pollutant removal efficiency, as compared to end-of-pipe treatment that allows for greater buildup of pollutants within concentrated flow. The project complies with all regulatory requirements associated with discharge into the municipal separate storm sewer system (MS4).

Proposed improvements will not obstruct implementation of the San Diego Basin Plan. The function of this Basin Plan is to designate and protect beneficial uses through implementation programs and monitoring. The San Diego Basin plan is governed via the Porter-Cologne Act (1969), which regulates point source and non-point source pollutants within the state of California; as well as the Nonpoint Source Management Plan (NPSMP, 1988, pursuant to section 319 of the Federal Clean Water Act), which establishes a statewide policy for managing storm water runoff. The San Diego Basin Plan is regulated through NPDES permits, issued by the Regional Board, to control source pollutants and protect receiving waters. Proposed improvements will comply with all NPDES regulations and will obtain permit coverage, thereby complying with the San Diego Basin Plan.

## APPENDIX A

*Tidal Hydraulics of Batiquitos Lagoon Relevant to Discharges from New Storm Water Infrastructure  
Improvements along North Coast Highway 101 within the City of Encinitas*

## **APPENDIX-A: Tidal Hydraulics of Batiquitos Lagoon Relevant to Discharges from New Storm Water Infrastructure Improvements along North Coast Highway 101 within the City of Encinitas**

**ABSTRACT:** A finite element hydrodynamic model was used to address potential water quality, erosion and sedimentation impacts to Batiquitos Lagoon due to incremental net additions of new storm water associated with infrastructure improvements along North Coast Highway 101 within the City of Encinitas. The study focuses on the largest of these improvements, the HWY 101-East storm drain with its associated dissipator structure. Discharges from this storm drain will runoff across vegetated high-tide refugia and into the south arm of the West Basin of Batiquitos Lagoon. The modeling utilized updated bathymetry provided by Merkel and Associates, (2008) and latest updates to Scripps Pier NOAA tides for the 1983-2001 tidal epoch. The model was calibrated to within 0.1 foot accuracy in predicted lagoon water levels.

**Findings for potential Erosion Impacts:** During flood tide, a sluggish disorganized eddy persists in the south arm of the West Basin in which velocities range from 0.02-0.04 m/s (0.06 – 0.13 ft/s), far below the threshold of motion of the native West Basin sands. Scour of these lagoon sands occurs at speeds of 0.8 ft/sec (0.24 m/sec). Similarly, on ebb tide, the south-arm currents in the West Basin do not exceed - 0.1 m/sec (-0.3 ft/sec), or 2.4 times smaller than threshold scour speed. Scour across the vegetated high tide refugia from the discharges of the HWY 101-East storm drain are also equally unlikely since the dissipator is designed to lower discharge velocities below 1 ft/s (the threshold scour speed of the sandy soils across the high tide refugia)

**Findings for Dilution and potential Salinity Depression Impacts:** Discharges into the West Basin of Batiquitos Lagoon from the HWY 101-East storm drain due to runoff from the 100-yr storm are calculated to yield 295,455 ft<sup>3</sup> (6.78 acre-ft) in a 28.74 hour period (1.16 diurnal tide cycles). The average volume of sea water stored in the West Basin over one diurnal tide cycle is 108 acre ft. Using the definition of dilution factor  $D_m$  under the California Ocean Plan ( $D_m$  = parts seawater per parts effluent), the storm runoff discharged by the HWY 101-East storm drain during a 100-yr event could not be any less than  $D_m$  = 15.9 to 1, assuming all of the storm water remained contained in the West Basin. In that case the salinity in the West Basin would be depressed by -1.98 ppt from 33.52 ppt for ambient seawater, down to 31.54 ppt. However, that amount of salinity depression would be a short-lived occurrence. After 1.9 days following session of runoff from the HWY 101-East storm drain (equivalent to West Basin residence time) the dilution factor would increase to no less than  $D_m$ = 796 to 1. Consequently, salinity in the West Basin would increase to 33.48 ppt, a mere -0.4 ppt below ambient sea water.

**Findings for potential Sedimentation Impacts:** The 100-yr event runoff event from the HWY 101-East storm drain are calculated to yield 0.13 cm of deposition of partially consolidated mud in the West Basin of Batiquitos Lagoon. This is certainly a *di minimis* amount of post-storm deposition, especially considering it is based on worst case assumptions that all storm water discharged from the HWY 101-East storm drain remains confined within the West Basin over a 1.9 day period.

# Tidal Hydraulics of Batiquitos Lagoon Relevant to Discharges from New Storm Water Infrastructure Improvements along North Coast Highway 101 within the City of Encinitas

By: Scott A. Jenkins, Ph.D.

## 1) Introduction:

This technical appendix addresses potential water quality and erosion impacts to Batiquitos Lagoon due to incremental net additions of new storm water associated with infrastructure improvements along North Coast Highway 101 within the City of Encinitas. These infrastructure improvements include new inlets and storm drains enhanced by new energy dissipator, median biofiltration basins, dispersion areas, and landscaped areas. The primary focus of the analysis herein is the East-101 outfall post project, located along N. Coast Highway 101, immediately north of La Costa Ave, consisting of a 24 in. RCP outfall that discharges runoff east of the 101 (east-101) into the south arm of the West Basin of Batiquitos Lagoon, (cf. Figure 1)

## 2) Technical Approach:

This study employs a well-tested and peer-reviewed hydrodynamic model to evaluate the tidal hydraulics of Batiquitos Lagoon based on updated bathymetry provided by Merkel and Associates, (2008) and latest updates to Scripps Pier NOAA tides for the 1983-2001 tidal epoch. The computer models used in this study are finite element types. The tidal hydraulics model is the research model, *TIDE\_FEM*, [Inman & Jenkins, 1996] and the littoral transport model is *TIDE\_FEM/SEDXPORT*. *TIDE\_FEM* was built from some well-studied and proven computational methods and numerical architecture that have been successful in predicting shallow water tidal propagation in Massachusetts Bay [Connor & Wang, 1974] and estuaries in Rhode Island, [Wang, 1975 ], and have been reviewed in basic text books [Weiyan, 1992] and symposia on the subject, e.g., Gallagher (1981). A discussion of the physics of *TIDE\_FEM* is given in Jenkins and Wasyl (2003 & 2005).

In its most recent version, the *TIDE\_FEM/TIDE\_FEM/SEDXPORT* modeling system has been integrated into the Navy's Coastal Water Clarity Model and the Littoral Remote Sensing Simulator (LRSS) (see Hammond, et al., 1995). The *TIDE\_FEM/SEDXPORT* code has been validated in mid-to-inner shelf waters (see Hammond, et al., 1995; Schoonmaker, et al., 1994). A detailed description of the architecture and codes of the *TIDE\_FEM/SEDXPORT* is given in Jenkins and Wasyl (2005) that is available on-line at the University of California digital library at: <http://repositories.cdlib.org/sio/techreport/58/>.

**3) Model Input:** The *TIDE\_FEM* model was gridded for the Batiquitos Lagoon bathymetry, based on the most recent lagoon soundings by Merkel and Associates, (2008). The 2008 survey did not provide bathymetric information above +5 ft MLLW; so consequently those data had to be merged with other survey data to obtain a complete picture of the lagoon over the entire tidal range. We began this merging exercise by building a bathymetric contour map from the 2008 survey data, obtaining bathymetric detail between -20 ft MLLW and + 5 ft MLLW. To fill in the upper mid- and high-marsh intertidal regions, bathymetric contours from the 2009 topographic survey were stitched into the 2008 bathymetric survey contours. The mid-marsh and high marsh contours were obtained from field surveys

conducted by WRA for the City of Carlsbad that were overlaid on a 3D terrain map to determine the elevation of each point. There was some variation in the elevations of these points from different transects (due primarily to the limitations in accuracy of both the GPS data and the original 1' contours). To compensate for this and to determine the appropriate MHW elevation for the lagoon, WRA took the mean elevation of all of the MHW points. WRA repeated this averaging procedure to create the 0.5 ft, 1 ft, 1.5 ft and 2 ft above MHW contour lines. While this procedure worked quite well throughout much of the lagoon, when creating a 3D model of the terrain in very flat (or topographically complex) portions of the lagoon the software encountered data gaps that resulted in fairly erroneous topographic data in these areas. This could not be avoided when using 1 ft contours. There were relatively few regions of error, and based on fairly straightforward vegetative signatures on the aerials; and using this vegetation data, WRA was able to manually correct the topography.

Upon completion of vetting the topographic data using vegetation types for co-registration, the six mid and high marsh contours between + 2 ft MLLW and extreme high water at + 7.7 ft MLLW were stitched into the master bathymetric file for Batiquitos Lagoon, producing the bathymetric map shown in Figure 2. The TIDE\_FEM tidal hydraulics model presented in Jenkins and Inman (1999) was gridded for a computational mesh of Batiquitos Lagoon built off the Figure 2 bathymetry. Of particular interest to the finite element mesh is the *hydraulic friction slope coefficient*,  $S_{fi}$ , providing tidal muting effects. Two separate formulations are used. One is given for the 3-node triangular elements situated in the interior of the mesh which do not experience successive wetting and drying during each tide cycle. The other formulation is for the elements situated along the wet and dry boundaries of the lagoon. These have been formulated as 3-node triangular elements with one curved side based upon the cubic-spline matrices developed by Weiyan (1992). These two sets of elements were assembled into a computational mesh of the lagoon conforming to the lagoon extreme high waterline in Figure 2. The wet-dry boundary coordinates of the curved waterline,  $(x', y')$ , are linearly interpolated for any given water elevation from the contours stored in the lagoon bathymetry file based on the updated lagoon bathymetry.

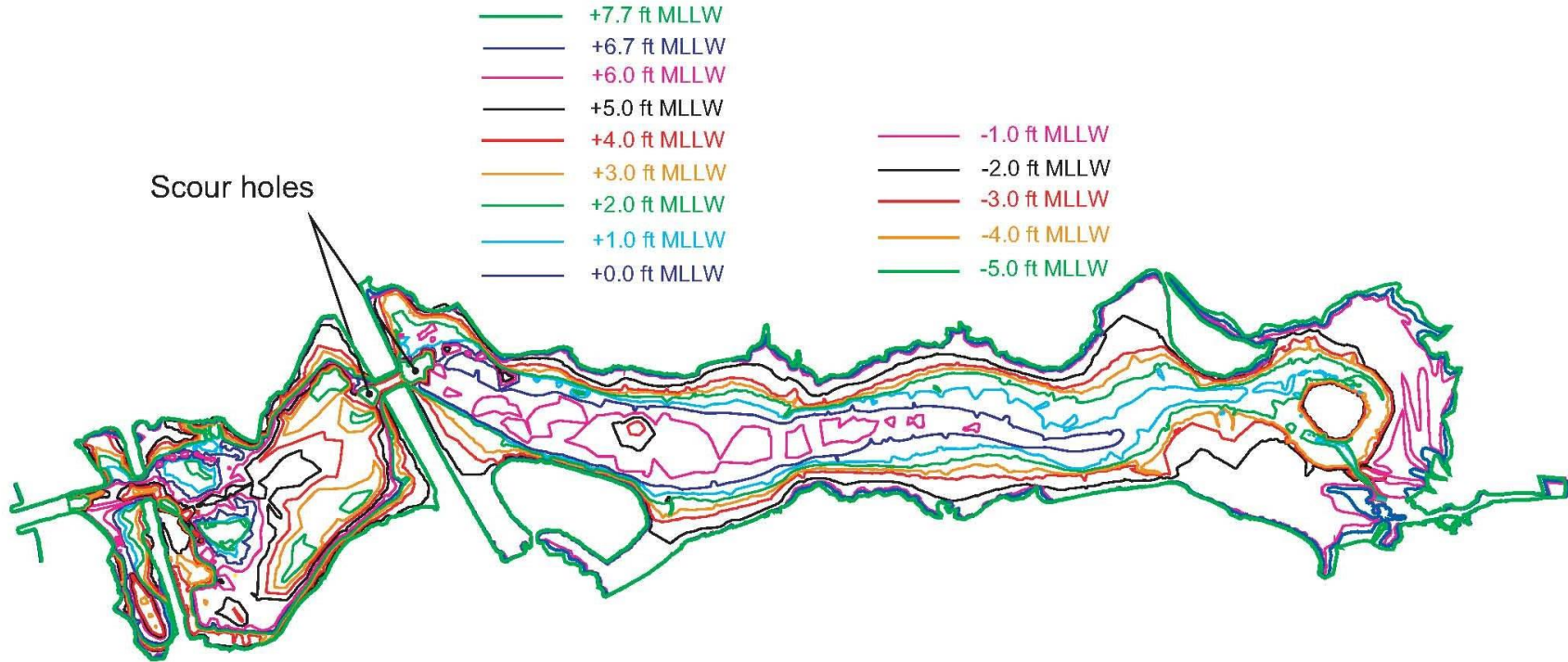
Aside from gridding the TIDE\_FEM tidal model, stage area and storage rating functions were calculated from the bathymetric contours of Figure 2. Figure 3 gives the composite storage rating function of the entire Batiquitos Lagoon system. The storage rating volume gives the volume of water in the lagoon as a function of the water elevation. The points indicated by crosses in Figure 3 are derived from integrating the volumes between each elevation contour in the Merkel (2008) data base. A best fit polynomial was matched to these points and provides an analytic relation for calculating the volume of water in the lagoon at any arbitrary water level. The polynomial derived from Figure 3 is also required in the initialization of the TIDE\_FEM tidal hydraulics model. From historic MHHW and MLLW levels in the lagoon, as reported in Merkel (2008), the storage rating function in Figure 3 gives a mean diurnal tidal prism of Batiquitos Lagoon of 1,515 acre-ft, while total storage volume at MHHW is 2160 acre-ft. Seventy on percent of the total storage volume (1533.6 acre-ft) resides in the East Basin, 24 % (518.4 acre-ft) is in the Middle Basin, while only 5% of the total storage volume of Batiquitos Lagoon (108 acre-ft) resides in the West Basin, (cf.Merkel, 2008).

### **3) Model Calibration and Assessment of Existing Conditions:**

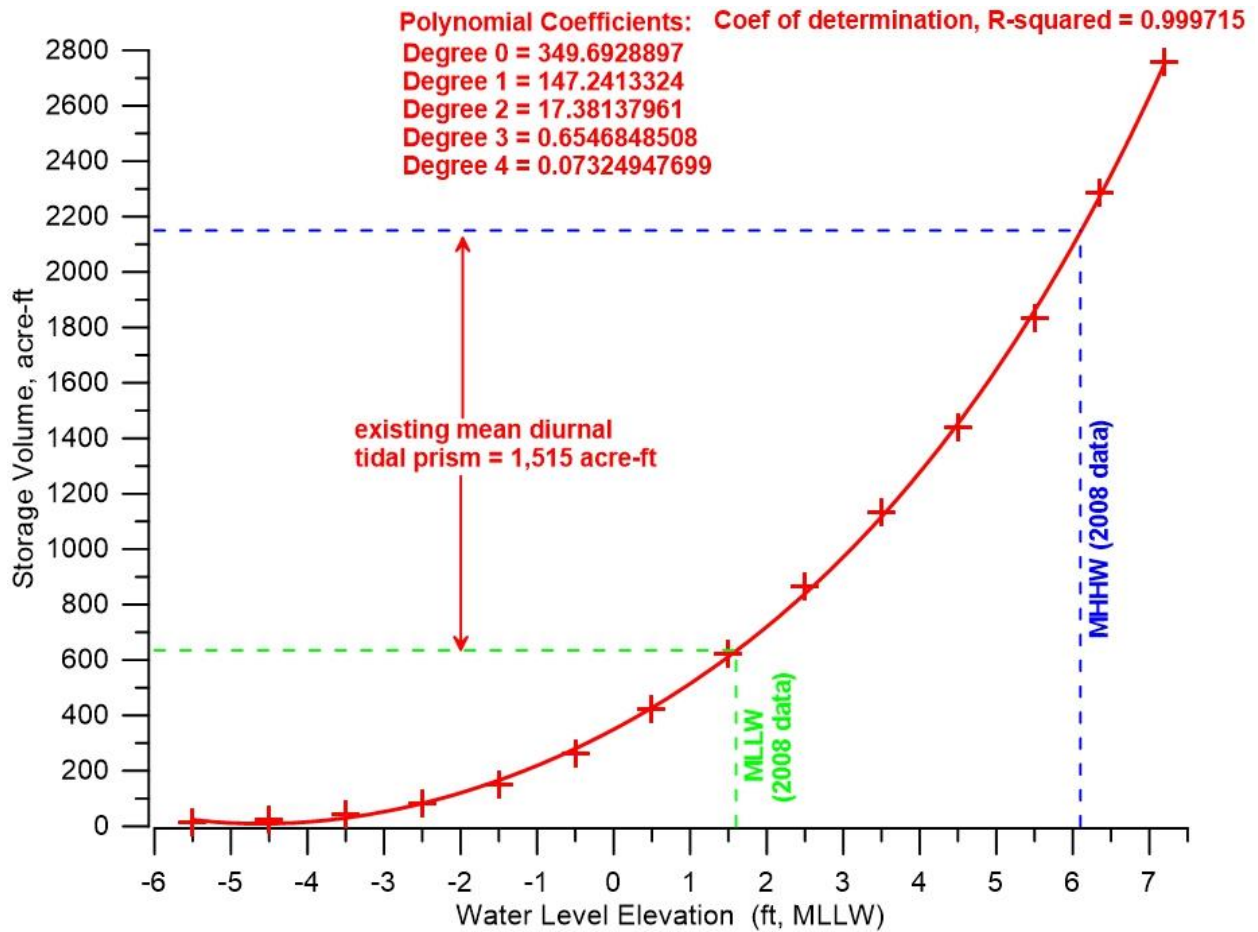
Spring, neap and mean tidal range simulations of the hydraulics of Batiquitos Lagoon were performed using astronomic tidal forcing functions at 2 sec time step intervals for the period 1980-2007, as



**Figure 1:** View of major components of the North Coast Highway 101 infrastructure improvements in the south arm of the West Basin of Batiquitos Lagoon including East 101 Outfall enhanced by new energy dissipator,



**Figure 2:** Bathymetry of Batiquitos Lagoon based on 2008 survey by Merkel (2008) merged with WRA land survey 2009, contours in ft. MLLW.



**Figure 3.** Storage rating function for Batiquitos Lagoon, based on 2008 sounding. Mean water levels for existing conditions from Merkel (2008).

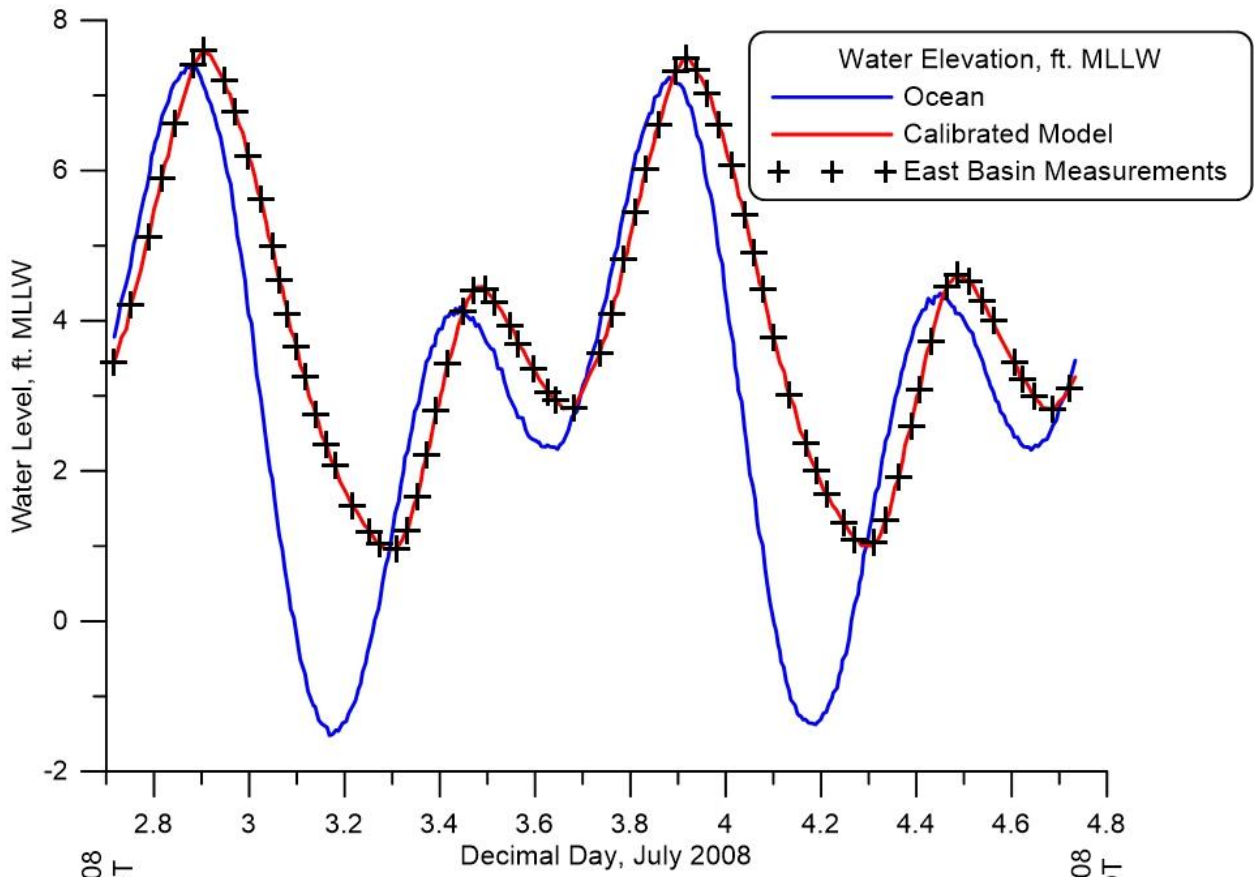


discussed in Section 2.1. Computed water surface elevations and depth-averaged velocities from the global solution matrix were converted to lagoon waterline contours and flow trajectories. Calibrations for determining the appropriate Manning factors and eddy viscosities were performed by running the TIDE\_FEM model on the Figure 2 bathymetry file and comparing calculated water surface elevations in the West, Central and East Tidal Basins against water level measurements reported in Merkel (2008) during September 2009. Iterative selection of Manning factor  $n_0 = 0.03406$  and an eddy viscosity of  $\varepsilon = 7.355 \text{ ft}^2/\text{sec}$  gave calculations of water surface elevation in the West, Central and East Basins that reproduced the measured values to within 2% over the 2008 monitoring period.

The most recent water level measurements in Batiquitos Lagoon were taken over a monitoring period of 2 July thru 6 October 2008, (Merkel, 2008). Figures 4-6 provides a quantitative assessment of the accuracy of the calibrated TIDE\_FEM model using water level measurements during spring tides in the east basin of Batiquitos Lagoon during the period of 2-14 July 2008. Figure 4 provides a comparison between East Basin water level variations predicted by the model (red trace) versus the actual water level measurements (black crosses) reported in Merkel (2008). The East Basin water level variations in red are found to lag the ocean water levels (blue trace) by as much as 53.7 minutes at higher high water (HHW) levels on flooding tides while this phase lag averages 180.4 minutes at lower low water (LLW) level during ebb tides. Higher high-water levels in the East Basin exceed those in the ocean by +0.22 ft, due to a trapped tidal mode (standing wave) typical of lagoons with large tidal basins and multiple choke point linkages to the ocean tides (Lamb, 1932; LeBlond & Mysak, 1978). Lower low water levels in the East Basin are +2.47 ft above ocean water levels. Thus the East Basin does not fully drain on ebbing tides due to the 180 minute phase lag, and consequently the East Basin tidal range suffers from 2.25 ft of tidal muting relative to ocean tidal ranges, where diurnal spring tide ranges in the ocean are  $\Delta\eta = 8.89 \text{ ft}$ . The amplitudes and degree of non-linearity in the East Basin water level time series simulated by the model closely duplicate that observed in the measured lagoon tides. The maximum error in simulating the low tide elevations was found to be  $\varepsilon_L = +0.08 \text{ ft}$ . The maximum high tide error in the model simulation relative to observations was found to be  $\varepsilon_H = -0.04 \text{ ft}$ .

Figure 5 compares East Basin water level variations predicted by the model (purple trace) with the actual water level measurements (black crosses) reported in Merkel (2008). The West Basin water level variations in purple are found to lag the ocean water levels (blue trace) by as much as 40.3 minutes at higher high water (HHW) levels on flooding tides; while this phase lag averages 109.4 minutes at lower low water (LLW) level during ebb tides. Higher high water levels in the West Basin are 0.10 ft lower than those in the ocean, while lower low water levels in the west basin are +1.31 ft above ocean water levels. Therefore, the West Basin does not fully drain either on ebbing tides due its 109 minute phase lag, and consequently the West Basin tidal range suffers from 1.41 ft of tidal muting relative to ocean tidal ranges. From these numbers it is apparent that about 63% of the tidal muting of the East Basin is attributable to the choke point at the PCH where the hardened ocean inlet channel crosses the barrier sand spit that segregates the lagoon from the beach. The amplitudes and degree of non-linearity in the West Basin water level time series simulated by the model closely duplicate that observed in the measured lagoon tides. The maximum error in simulating the low tide elevations was found to be  $\varepsilon_L = +0.075 \text{ ft}$ . The maximum high tide error in the model simulation relative to observations was found to be  $\varepsilon_H = -0.035 \text{ ft}$ .

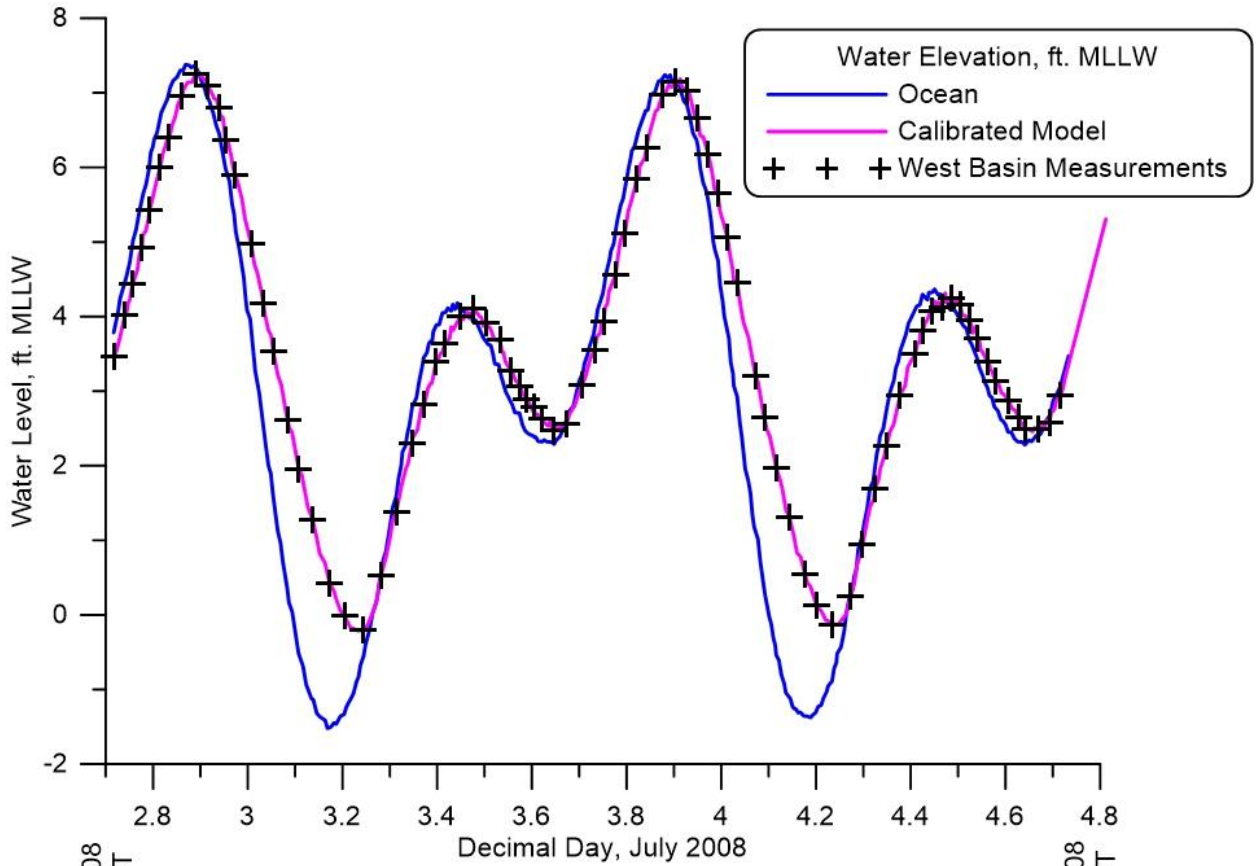
Figure 6 compares Central Basin water level variations predicted by the model (green trace) with the actual water level measurements (black crosses) reported in Merkel (2008). The Central Basin water



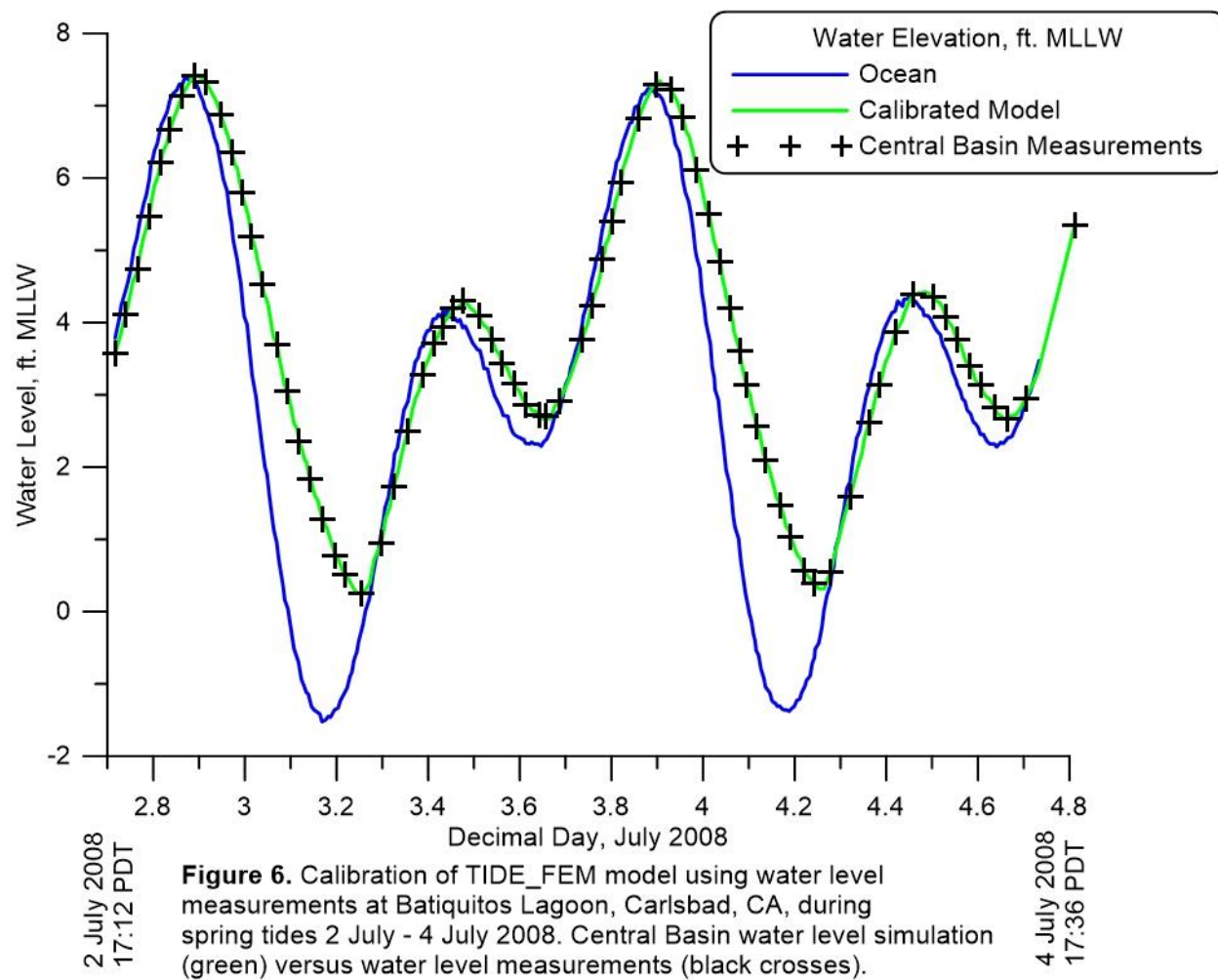
2 July 2008  
17:12 PDT

**Figure 4.** Calibration of TIDE\_FEM model using water level measurements at Batiquitos Lagoon, Carlsbad, CA, during spring tides 2 July - 4 July 2008. East Basin water level simulation (red) versus water level measurements (black crosses).

4 July 2008  
17:36 PDT



**Figure 5.** Calibration of TIDE\_FEM model using water level measurements at Batiquitos Lagoon, Carlsbad, CA, during spring tides 2 July - 4 July 2008. West Basin water level simulation (purple) versus water level measurements (black crosses).



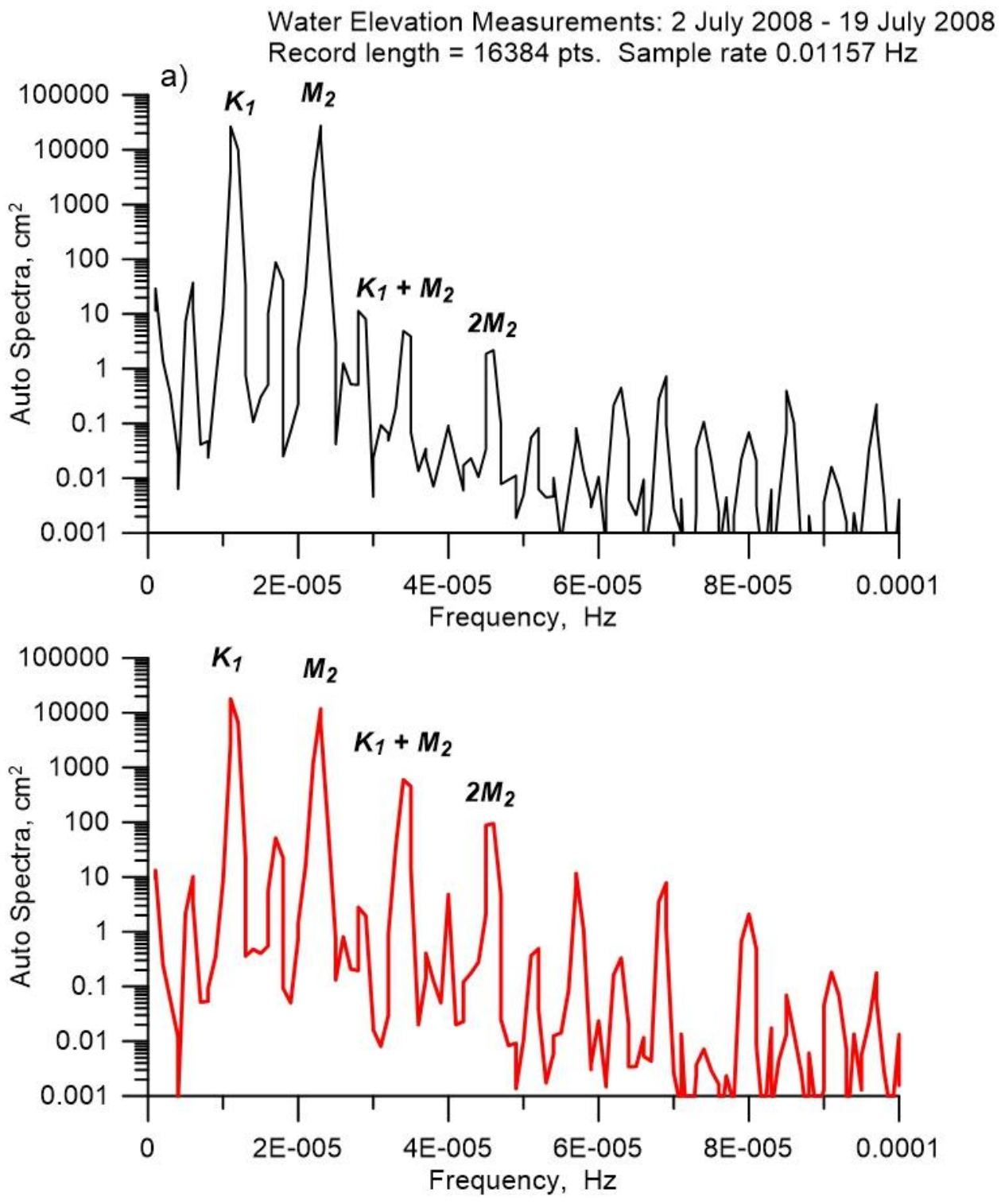
level variations in green are found to lag the ocean water levels (blue trace) by as much as 43.8 minutes at higher high water (HHW) levels on flooding tides; while this phase lag averages 124 minutes at lower low water (LLW) level during ebb tides. Higher high water levels in the Central Basin are 0.04 ft higher than those in the ocean, while lower low water levels in the West Basin are +1.77 ft above ocean water levels. Therefore the Central Basin also does not fully drain on ebbing tides due its 124 minute phase lag, and consequently the Central Basin tidal range suffers from 1.72 ft of tidal muting relative to ocean tidal ranges. From these numbers it is apparent that about 76% of the tidal muting of the East Basin is attributable to the combination of choke points at the PCH and railroad bridges. The amplitudes and degree of non-linearity in the West Basin water level time series simulated by the model closely duplicate that observed in the measured lagoon tides. The maximum error in simulating the low tide elevations was found to be  $\varepsilon_L = +0.075$  ft. The maximum high tide error in the model simulation relative to observations was found to be  $\varepsilon_H = -0.035$  ft.

In all three cases of the West, Central and East Basin water levels, the calibration error appears to exhibit a systematic tendency. When amplitude errors occur they tend to over estimate the water elevation of the LLW tidal stage, and under estimate the water elevation of the HHW tidal stage. Although these errors are quite small and may be considered high predictive skill, this error mode would be consistent with *bathymetry errors* in which depth has been under estimated, Weiyan (1992). Bathymetry errors are the most common cause of modeling errors.

In Figure 7a, auto spectra of the ocean tides (black, upper panel) shows the predominant energy is centered on a diurnal frequency of the K1 lunar-solar diurnal tidal constituent at  $f_{K1} = 1.16079 \times 10^{-5}$  Hz. The energy in this peak is disproportionately high relative to the next largest spectral peak occurring at the M2 principal lunar semi-diurnal tidal constituent,  $f_{M2} = 2.2365 \times 10^{-5}$  Hz. The excess energy at diurnal frequencies is believed to be non-tidal and attributable to a wind-driven current component that has a diurnal fluctuation in response to daily heating of the land. With the onset of a strong thermal low over the inland deserts during July 2008, this diurnal sea breeze component would be expected to be very strong in the time frame of the lagoon monitoring.

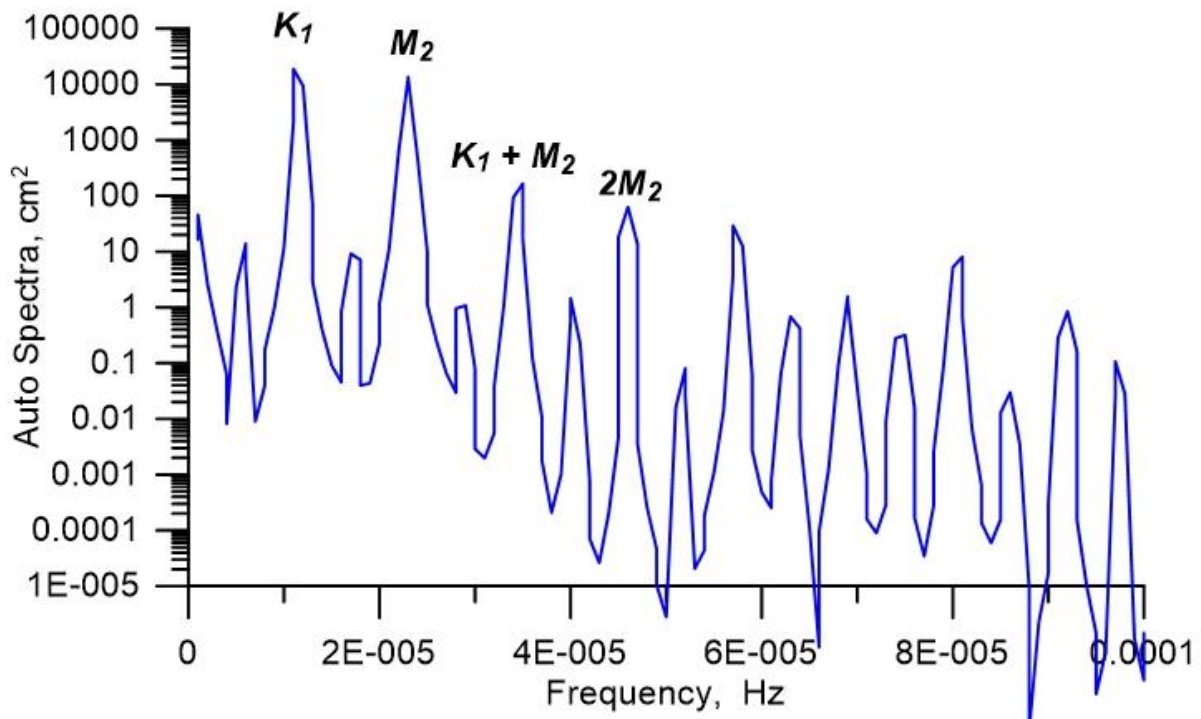
Other less energetic tidal peaks are also found in the spectra of Figure 7a, including one believed to be a baroclinic *shelf resonance* formed by a resonant *triad* at the sum of the frequencies of the K1 and M2 barotropic tides, ie a diurnal third harmonic at a frequency  $f_3 = f_{K1} + f_{M2} = 3.3973 \times 10^{-5}$  Hz. This diurnal third harmonic is a baroclinic tide excited by the barotropic K1 and M2 tides interacting with the bottom topography, in particular the local shelf and Scripps Submarine Canyon to the south. Another baroclinic shelf resonance apparent in the spectra of the ocean tides in Figure 7a is a second harmonic of the barotropic M2 tide appearing at a frequency of  $2f_{M2} = 4.4730 \times 10^{-5}$  Hz.

The auto spectra of the East Basin tides shown in red in the lower panel of Figure 7b exhibits the same primary barotropic and baroclinic tidal peaks as the ocean tides in the upper panel; with one exception; an additional non-linear resonance appears as a triad formed by the sum of the K1 barotropic mode and the baroclinic second harmonic of the M2 tide,  $f_{K1} + 2f_{M2} = 5.6338 \times 10^{-5}$  Hz. Apparently this mode is excited by non-linear tidal interaction with the lagoon bathymetry. Similar tidal harmonics are found in the auto spectra of the West Basin in Figure 8a and in the Central Basin in Figure 8b.

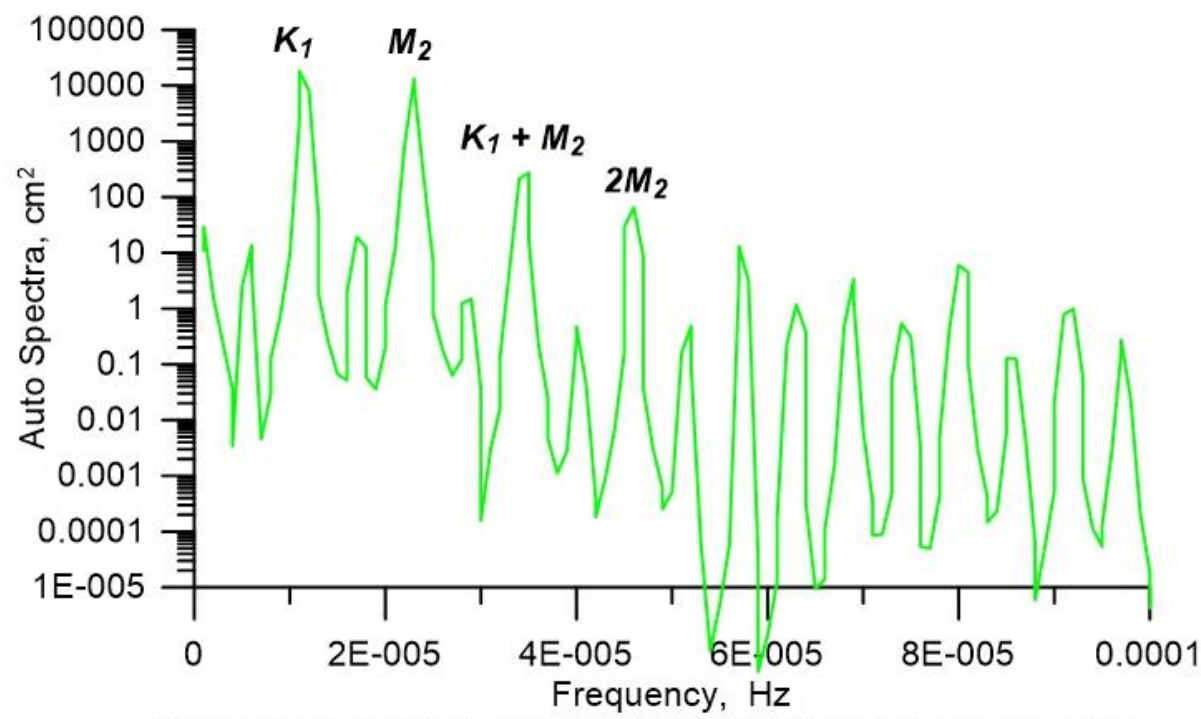


**Figure 7.** Auto spectra of water level measurements: a) Ocean water level at inlet to Batiquitos Lagoon, b) water level in the East Basin of Batiquitos Lagoon.

Time = simulated 2 July 2008 - 19 July 2008, West Basin water elev.  
Record length = 16384 pts. Sample rate 0.01157 Hz



Time = simulated 2 July 2008 - 19 July 2008, Central Basin water elev.  
Record length = 16384 pts. Sample rate 0.01157 Hz



**Figure 8.** a) Batiquitos Lagoon West Basin water level spectra;  
b) Batiquitos Lagoon Central Basin water level spectra.

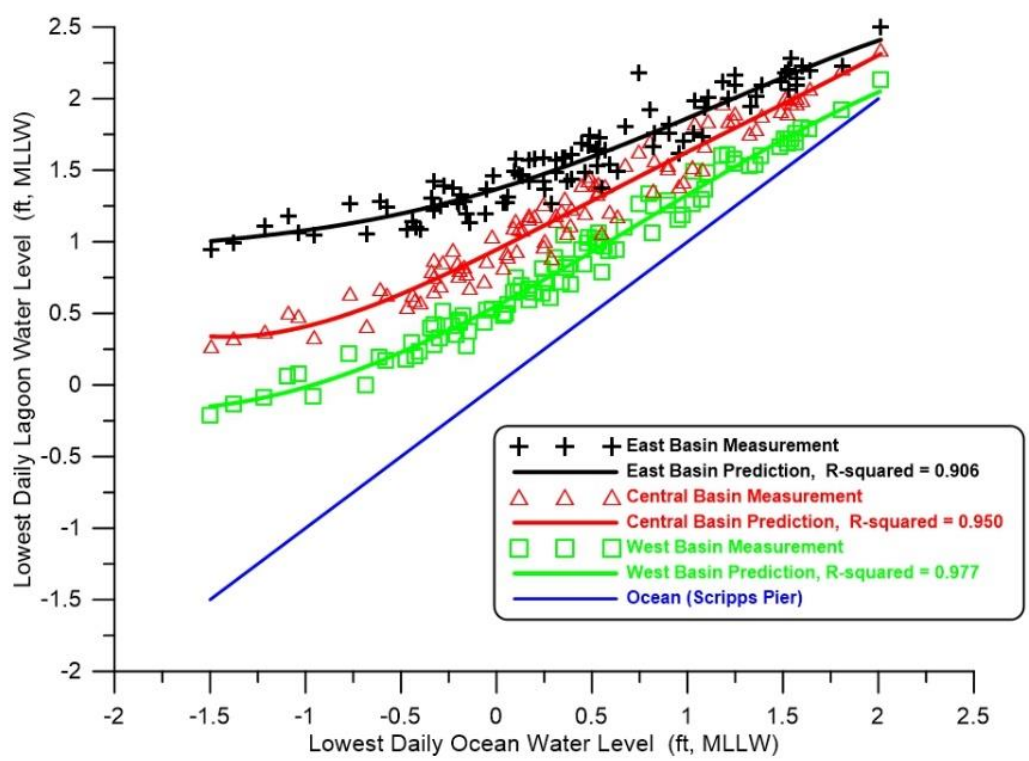
**Table 4.1:** Water Levels for Batiquitos Lagoon with 2008 Tidal Forcing from Scripps Pier NOAA tide Gage

Elevations Feet MLLW	Ocean	West Basin	Central Basin	East Basin
MEAN HIGHER HIGH WATER (MHHW)	5.7	5.8	6.0	6.1
MEAN HIGH WATER (MHW)	5.0	5.0	5.2	5.3
MEAN LOW WATER (MLW)	1.3	1.6	1.9	2.2
MEAN LOWER LOW WATER (MLLW)	0.4	0.9	1.2	1.6
LOWEST OBSERVED WATER LEVEL	-1.5	-0.2	0.3	0.9
HIGHEST OBSERVED WATER LEVEL	7.4	7.3	7.4	7.6
MAXIMUM TIDAL RANGE	8.9	7.5	7.1	6.7

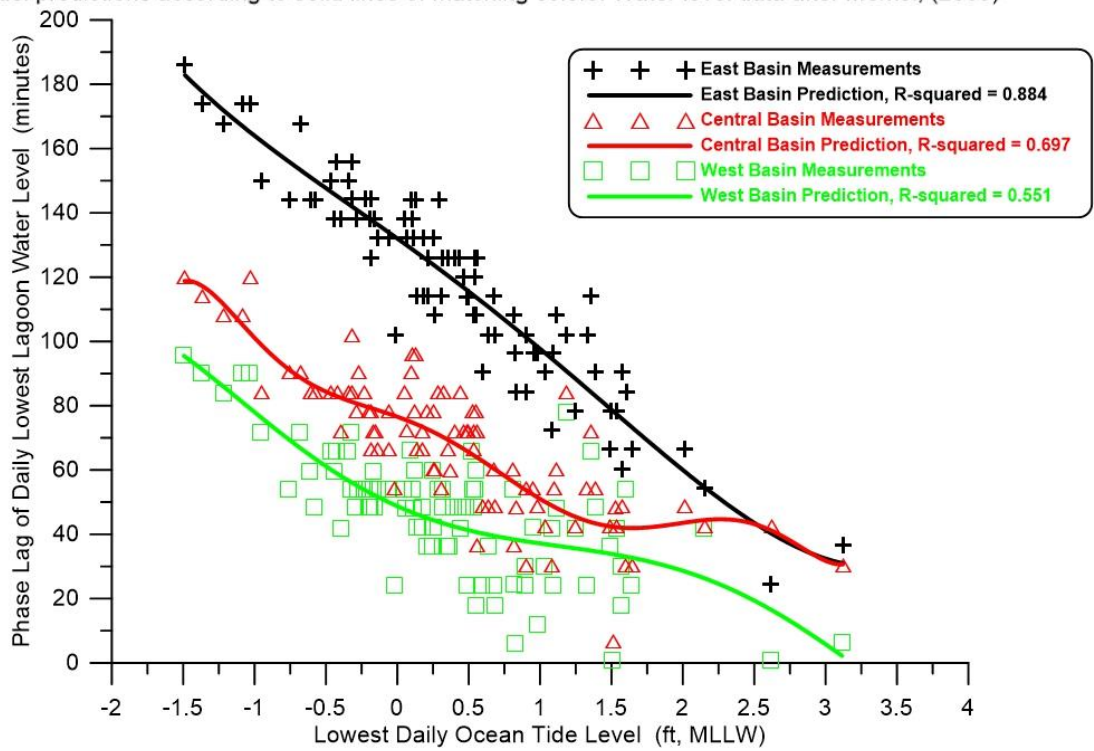
Table 4.1 gives a summary of the water level elevations calculated by the calibrated model for Batiquitos Lagoon based on long-term tidal simulations using historic ocean water level forcing for the 2008 period of record.

Additional quantitative evidence of high predictive skill of the calibrated model is given in Figure 9 over the entire period of monitoring 2 July – 6 October 2008 for lowest daily water levels in the West, Central, and East Basins, and for phase lags in the three basins in Figure 10. The coefficient of determination of model predictions of daily lowest water level in Figure 9 for the East Basin is found to be  $R^2 = 0.906$ , while  $R^2 = 0.950$  for the Central Basin, and  $R^2 = 0.977$  was found for the West Basin. Predictive skill of phase lags in Figure 10 was found to be  $R^2 = 0.884$  in the East Basin;  $R^2 = 0.697$  in the Central Basin and  $R^2 = 0.551$  for the West Basin. Figures 9 & 10 serve to emphasize the controlling effects that the choke points of the I-5, railroad and PCH bridges have on constraining tidal range under existing conditions in the three basins at Batiquitos Lagoon. In Section 4.3.1 we will examine the effects which the I-5 replacement bridge may have on existing conditions and explore possible alternative bridge waterway channels and road bed fill removal options for partially relaxing these choke point constraints on tidal exchange.





**Figure 9.** Daily lowest water level in Batiquitos Lagoon versus daily lowest water level in the local ocean as measured at the Scripps Pier tide gage (NOAA #941- 0230). Measured values indicated by symbols, model predictions according to solid lines of matching colors. Water level data after Merkel, (2008)

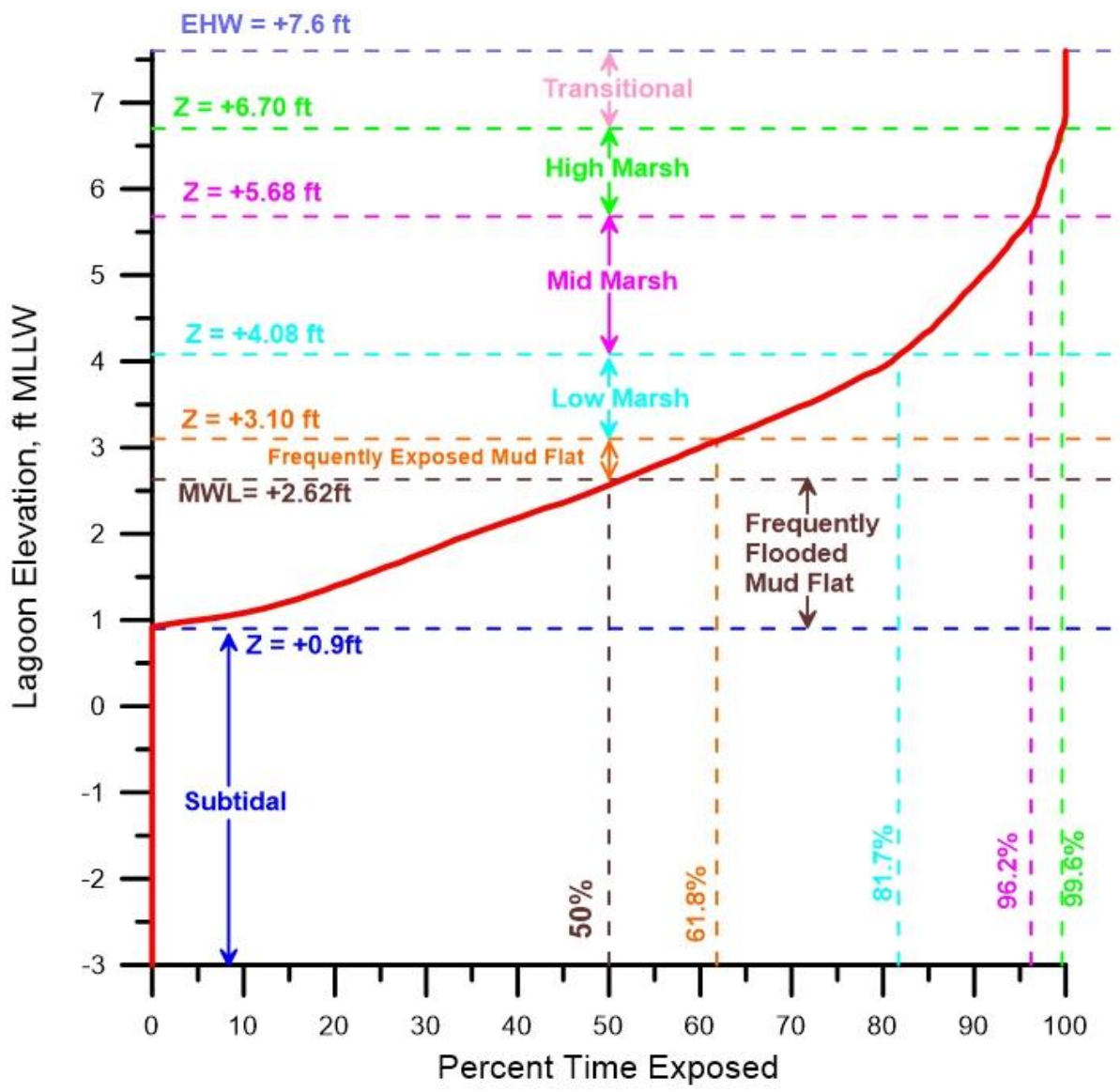


**Figure 10.** Phase lag of daily lowest water level in Batiquitos Lagoon relative to daily lowest water level in the local ocean as measured at the Scripps Pier tide gage (NOAA #941- 0230). Measured values indicated by symbols, model predictions according to solid lines of matching colors. Water level data after Merkel, (2008)

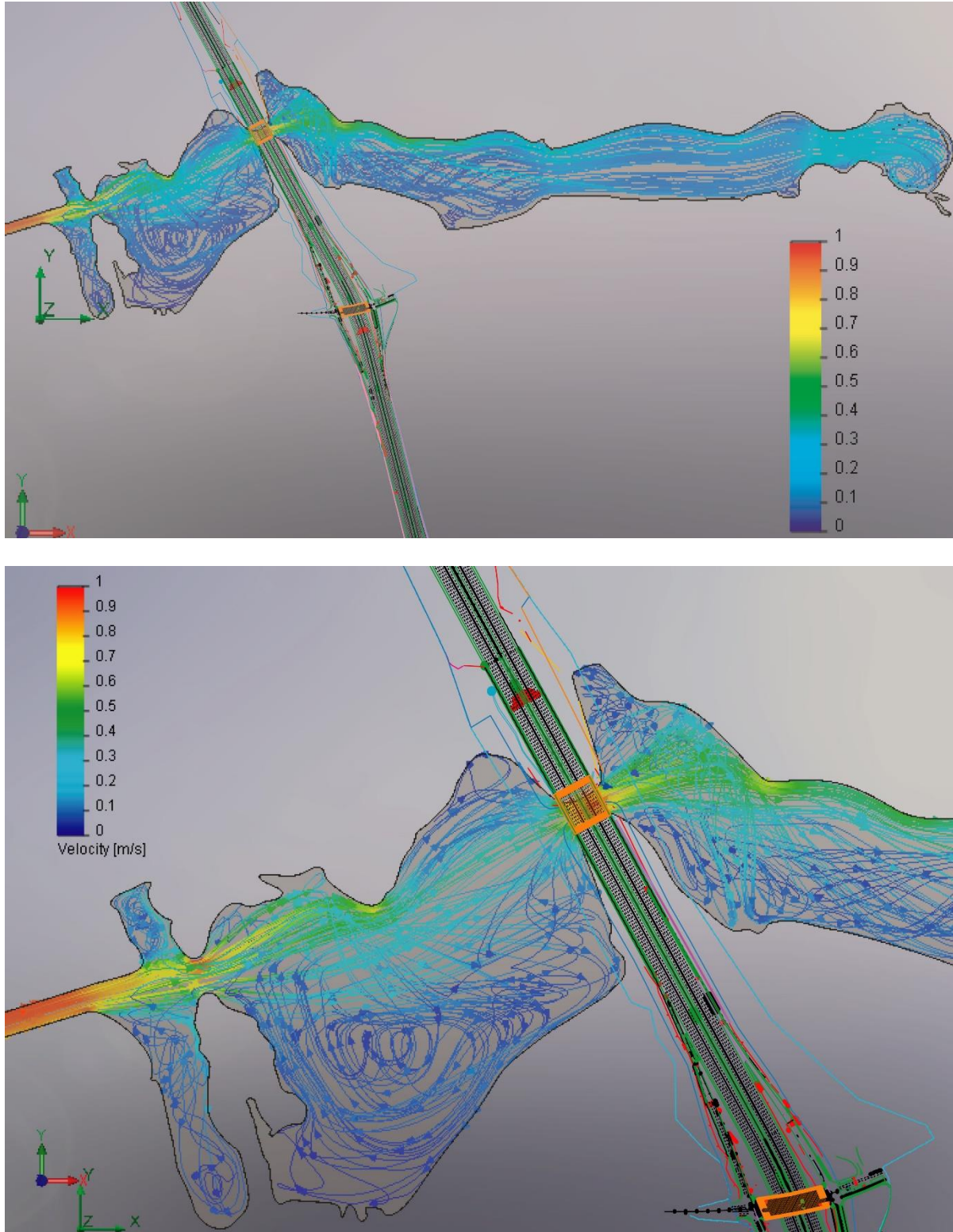
Figure 11 gives the hydroperiod function for the Batiquitos lagoon ecosystem with the existing I-5 bridge, based on the relationships between habitat breaks based on biological surveys of wetland habitat after Josselyn, M. & A. Whelchel, (1999). The hydroperiod function in Figure 11 is based on tidal forcing using the Scripps Pier ocean water level measurements 1980-2010 to drive the tidal hydraulics model at the ocean inlet to Batiquitos Lagoon and compute the percent time the lagoon topography is exposed at a particular elevation. Comparing Figure 11 with the hydroperiod function for San Dieguito Lagoon, it is apparent how the phase lag in Batiquitos lagoon, and its inability to fully drain on lower low water stages, has compressed the present intertidal habitat and raised the zonation of low mid and high marsh vegetation. This also greatly diminishes the amount of frequently exposed mud flats that support bird habitat. We can map the elevations of the habitat breaks of the hydroperiod function in Figure 11 against the stage area function to estimate the proportions of habitat types in the lagoon. This procedure gives the minimum sub-tidal and maximum intertidal habitat types since the hydroperiod function is based on the full range of water level variation over long periods of time (2008 period of record). The preponderance of wetland habitat resides in the East Basin. The minimum (perpetual) sub-tidal area of the East Basin is 91.3 acres; there are maximum of 58.6 acres of frequently flooded mud flat; 13.6 acres of frequently exposed mud flat; 42.3 acres of low salt marsh; 77.0 acres of mid salt marsh; 45.8 acres of high salt marsh; and 30.2 acres of transitional habitat. The maximum area inundated by salt water at extreme high water is 358.9 acres of which 91.3 acres are sub tidal with at most 267.7 acres of intertidal habitat that experiences tidal inundation at least once in the period of record. An average of 302.7 acres experiences tidal inundation up to MHHW resulting in an average of 191.4 acres of intertidal habitat and 111.3 acres of sub-tidal habitat.

#### **4. Tidal Flow Velocity Simulations in Batiquitos Lagoon**

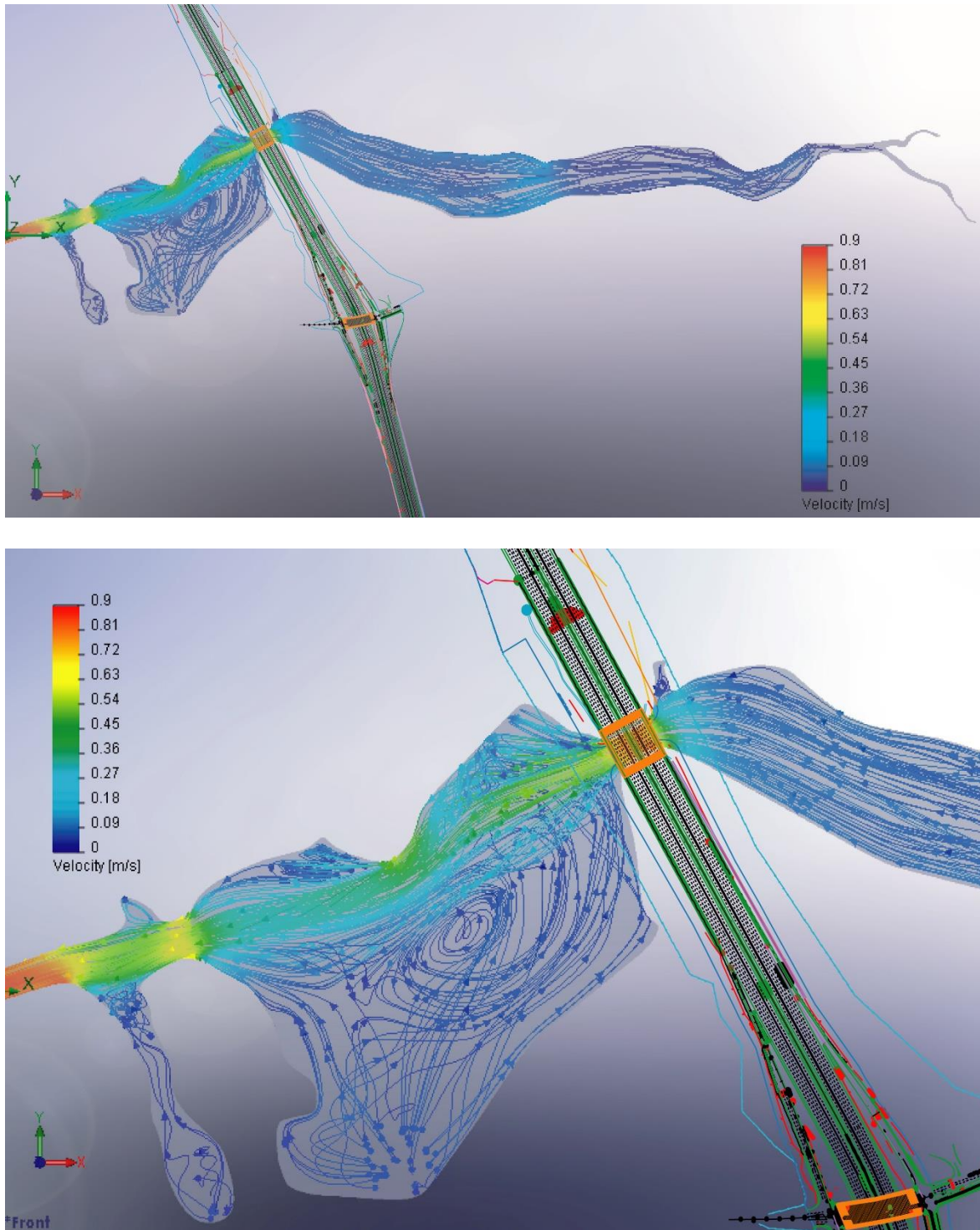
Figure 12 (upper panel) gives the flow trajectories and depth-averaged tidal currents computed by the calibrated TIDE\_FEM model with the replacement bridge during the mean range flooding tides selected at the end of Section 2.0. Figure 12 (lower panel) shows fine scale flow details in the tidal channel near the replacement I-5 bridge, while Figure 13 provides the same for mean ebbing tides. The examples shown in Figures 12 and 13 use the existing hard bottom bridge waterway channel at -3 ft MLLW. Streamline patterns, flow trajectories and velocities are indistinguishable from those found for the narrower, present day I-5 bridge using the same hard bottom channel cross section. With both existing and replacement bridges, maximum flood currents in the inlet channel reach 0.97 m/sec or 3.18 ft/sec. Flood tide currents entering the lagoon form a well-defined jet through the West Basin and into the Central Basin at speeds of roughly 0.6 m/s (1.96 ft/sec), sufficient to transport fine grained beach sand in the 120-210 micron size regime into the West Basin and beyond. A sluggish disorganized eddy with velocities ranging from 2-4 cm/s (0.06 – 0.13 ft/s) persists in the south arm of the West Basin while the middle portion is near stagnation, ideal conditions for fine sand to settle and form sand bars of beach grade sand. The flood tide jet exiting the West Basin speeds back up to as high as to 0.9 m/sec (2.95 ft/sec) as it passes through the hardened channel under the rail road bridge and then loses energy as it diverges into the Central Basin, spinning up a somewhat disorganized Central Basin eddy. The core of the Central Basin eddy is at stagnation, again providing ideal conditions for suspended beach grade sand to settle and deposit as a Central Basin sand bar. Flood tide currents speed back up to 0.7 m/sec (2.3 ft/sec) through the hardened channel under the both the existing and replacement I-5 bridge before diverging into a complex set of swirls and counter rotating eddies that populate the East Basin. East Basin swirl and eddy speeds are on the order of 0.1 m/sec (0.3 ft/sec), insufficient to transport fine sand



**Figure 11.** Hydroperiod function for the Batiquitos Lagoon ecosystem with existing I-5 bridge and bathymetry. Based on hydrodynamic simulation of water levels in response to tidal forcing from the Scripps Pier tide gage (NOAA # 941-0230). Habitat breaks based on habitat delineation from Josselyn and Whelchel (1999).



**Figure 12:** Hydrodynamic simulation of maximum flood flow during mean range tides at Batiquitos Lagoon with the proposed I-5 replacement bridge for the North Coast Corridor Project



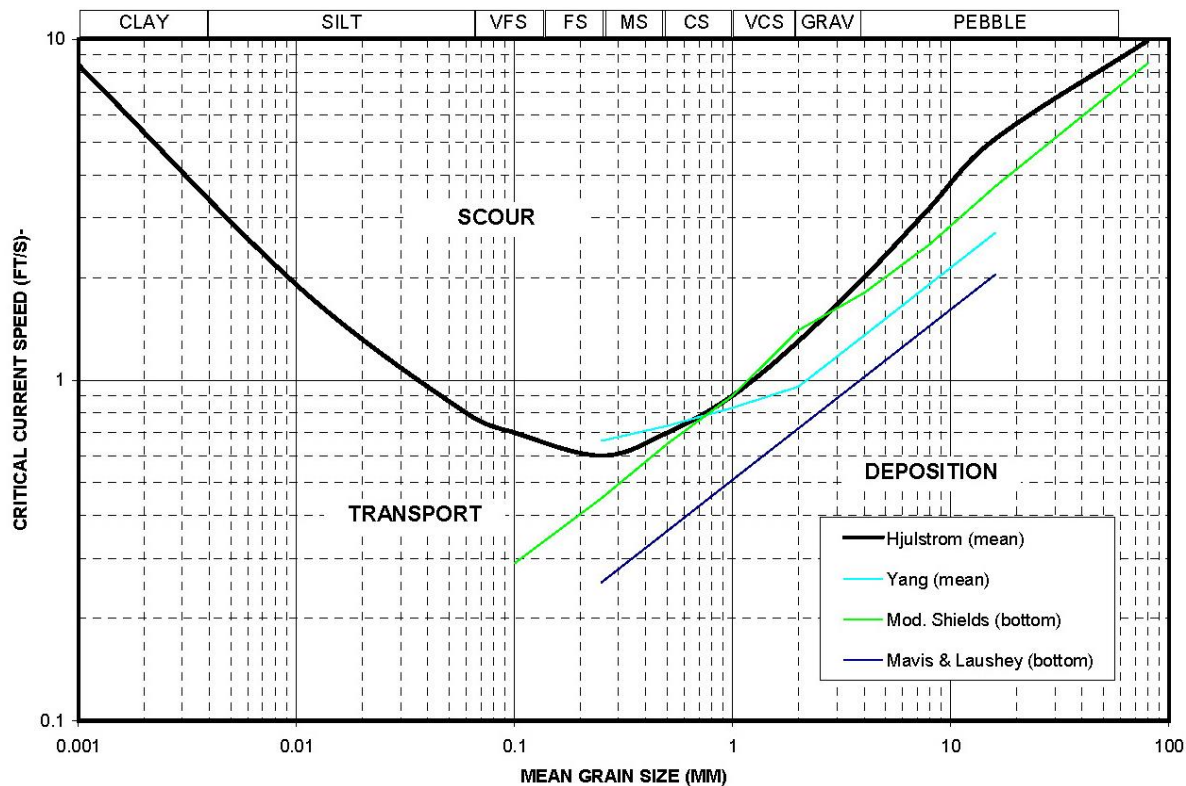
**Figure 13:** Hydrodynamic simulation of maximum ebb flow during mean range tides at Batiquitos Lagoon with the I-5 replacement bridge for the North Coast Corridor Project.

but an important stirring mechanism for mixing the East Basin water mass to maintain high oxygen levels and to maintain silt and clay sized sediment particles in suspension.

Figure 13 plots the TIDE\_FEM simulation of ebbing mean range tidal flows. The wetted area of the lagoon is significantly reduced relative to the flood tide area in Figure 12, due to the lower water levels acting on the storage rating curve in Figure 3. A creeping flow with complex structure on the order of -0.1 m/sec (-0.3 ft/sec) evacuates the East Basin and accelerates to -0.6 m/s (-1.9 ft/sec) as it passes through the hardened channel under either the existing or replacement I-5 bridge. A vigorous well-ordered Central Basin eddy is spun up by an ebb-tide jet flowing along the northern bank of the Central Basin. This jet accelerates to -0.63 m/sec (-2.1 ft/sec) as it passes through the hardened channel under the railroad bridge; and then splits into a south-arm current as it diverges into the West Basin. The south-arm current flows along the west bank of the West Basin at a rate of about -0.1 m/sec (-0.3 ft/sec) and exits the lagoon through the ocean inlet. Maximum ebb flow currents in the inlet channel are -0.9 m/sec (-2.95 ft/sec) slightly less than on flooding tide due to the flood tide dominance of the lagoon system. It is this flood tide dominance of the inlet channel flows that leads to the continuous net influx of beach sand into the lagoon that has required 206,838 cubic yards of maintenance dredging of the West and Central Basins between 1998 and 2008.

The fine-scale flow similarities between the existing and proposed replacement I-5 bridge simulations is born out in duplicate scour features found for these two sets of simulations. In either case tidal flows under the I-5 bridge reach 0.7 m/sec (2.3 ft/sec) during flood tide and 0.6 m/s (1.9 ft/sec) during ebb. These velocities through the existing and proposed I-5 bridge waterway are about double the threshold of motion of the relict sediments of the lower San Marcos Creek. The preponderance of sediments near the I-5 bridge at channel station 3750 are in the medium to coarse sand size with a mean grain size of about 0.6 mm to 1 mm (Merkel, 2008). Figure 14 gives several of the most commonly used threshold of motion criteria, after (Everest 2007), indicating that these sands would reach the threshold of motion in tidal stream flows greater than 0.8 ft/sec to 1 ft/sec (0.24 m/sec to 0.31 m/sec), or about one half the maximum currents under the existing and proposed replacement I-5 bridges during mean range tides. Consequently, when the tidal current exits from the hard channel bottom under the bridge to the soft sedimentary bottom of the lagoon tidal basin, these super-critical tidal currents scour deep holes on either side of the I-5 bridge, both for the existing bridge and the proposed replacement bridge being proposed for the North Coast Corridor Project. In either case, the channel is so narrow and constrained in cross section by the 246 ft bridge span that two 20 ft deep scour holes have formed on either side of the I-5 bridge (see Figure 2) due to the excess velocity head of the tidal flow passing under the bridge. The bridge waterway is presently too narrow, and that condition is not corrected by the replacement bridge proposed for the North Coast Corridor Project. As a result the kinetic energy of the high speed tidal flows (velocity head) in this narrow, hardened channel is being wasted in turbulence and sediment transport to scour the 20 ft deep holes in the lagoon bathymetry, rather than being reconverted into potential energy as pressure (water level elevation) after passing under the bridge into the eastern tidal basin. This results in as much as 2.2 ft of tidal muting in the East Basin relative to the ocean tides, and a phase lag at MLLW of as much as 186 minutes between the East Basin and the ocean that is not improved by the present proposed replacement bridge design. With either bridge design, the East Basin phase lag averages 117 minutes.

During flood tide a sluggish disorganized eddy persists in the south arm of the West Basin in which velocities range from 2-4 cm/s (0.06 – 0.13 ft/s), far below the threshold of motion of the native West Basin sands. Scour and occurs at speeds of about 0.8 ft/sec (0.24 m/sec). Similarly, on ebb tide, the



**Figure 14:** Critical current speeds for quartz sediment as a function of mean grain size, (from Everest, 2007).

the south-arm currents in the West Basin do not exceed  $-0.1$  m/sec ( $-0.3$  ft/sec), or 2.4 times smaller than threshold scour speed. Therefore, no tidal scour is possible anywhere near the discharge plume from the HWY 101-East storm drain and dissipator. Scour across the vegetated high tide refugia from the discharges of the HWY 101-East storm drain are also equally unlikely since the dissipator is designed to lower discharge velocities below 1 ft/s (the threshold scour speed of the sandy soils across the high tide refugia).

## 5. Water-mass Residence Times in Batiquitos Lagoon

Residence time refers to the average amount of time source water spends in a particular tidal system. Residence time begins from the moment a *material element of water* (a parcel that tide and ends when that same element leaves the system on ebbing tide. At lowest order, *removal time* is used as a *conceptual proxy* for the age of water in a particular tidal system. Removal time is a ratio of the storage capacity of that system to the rate of tidal exchange during a diurnal tidal period (Horikawa, 1988; Schwartz, 2005), or:

$$\bar{\tau} = \frac{V_s}{V_p} T \quad (1)$$

Where  $\bar{\tau}$  is the removal time;  $V_s$  is the storage capacity including both the inlet channel and tidal basins;  $V_p$  is the diurnal tidal prism, and  $T$  is a diurnal tidal period equal to 1.0347 days (24 hours and

50 minutes). Figure 2 gives the storage rating function of the entire Batiquitos system with no displacement losses due to an inlet bar, while Figure 3 gives the storage capacity of the lagoon at MHHW level, which is  $V_s = 2,160$  acre ft, but because of the West Basin inlet bar and shoals the mean tidal prism during spring tides of about  $V_p = 1,515$  acre ft. Thus, during spring tides, the bulk-average removal time for the entire lagoon system would average  $\bar{\tau} = 1.48$  days. When the tidal prism is less than the storage capacity of a lagoon, it takes a number of tide cycles to completely replace all of the *old water* in each of the basins that make up the lagoon.

Old water is defined here as water that remains in the tidal system (including both inlet channel and tidal basins) after water outflow during ebb tide. As new ocean water comes into the tidal system with the onset of each flood tide, the old water becomes more diluted with each successive tidal cycle until all the old water is eventually replaced by new water. Because total replacement of old water by new water is an asymptotic process, we adopt the convention of assigning residence time as the time required for old water to dilute to less than 2% of the storage capacity of the system (cf. Horikawa, 1988; Schwartz, 2005).

Figures 15-17 give the mass-balance calculations of the dilution curves for old water in each of the three basins of the Batiquitos Lagoon, based on the tidal exchange solutions of the TIDE\_FEM model detailed in Section 4 above. On average, the amount of old water in the East Basin diluted to less than 2% after 3.2 days (residence time), while residence time reduces to 2.3 days in the Middle Basin and 1.9 days in the West Basin. Because the lagoon drains more completely during ebbing spring tides than during ebbing neap tides; it is sensible to find an envelope of tidal variability around each of the mean dilution curves in Figures 11-13. While residence times in the East Basin averaged 3.2 days over the monitoring period, residence time declined to 2.2 days during spring tides and increased to 4.5 days during neap tides (Figure 11). Similarly residence times reduced to as little as 1.0 days during spring tides in the West Basin, increasing to 2.7 days during neap tides.

## 6. Dilution and Residence Time of 100-yr Storm Discharges from the HWY-101-East Storm Drain

Discharges into the West Basin of Batiquitos Lagoon from the HWY 101-East storm drain due to runoff from the 100-yr storm are calculated to yield 295,455 ft<sup>3</sup> (6.78 acre-ft) in a 28.74 hour period (1.16 diurnal tide cycles). The average volume of sea water stored in the West Basin over one diurnal tide cycle is 108 acre ft. Using definition of dilution factor  $D_m$  under the California Ocean Plan ( $D_m = \text{parts seawater per parts effluent}$ ), the storm runoff discharged by the HWY 101-East storm drain during a 100-yr event could not be any less than  $D_m = 15.9$  to 1, assuming all of the storm water remained contained in the West Basin. In that case the salinity in the West Basin would be depressed by -1.98 ppt from 33.52 ppt for ambient seawater, down to 31.54 ppt\*. However, that amount of salinity depression would be a short-lived occurrence. After 1.9 days following session of runoff from the HWY 101-East storm drain (equivalent to West Basin residence time) the dilution factor would increase to no less than  $D_m = 796$  to 1. Consequently, salinity in the West Basin would increase to 33.48 ppt, a mere -0.4 ppt below ambient sea water.

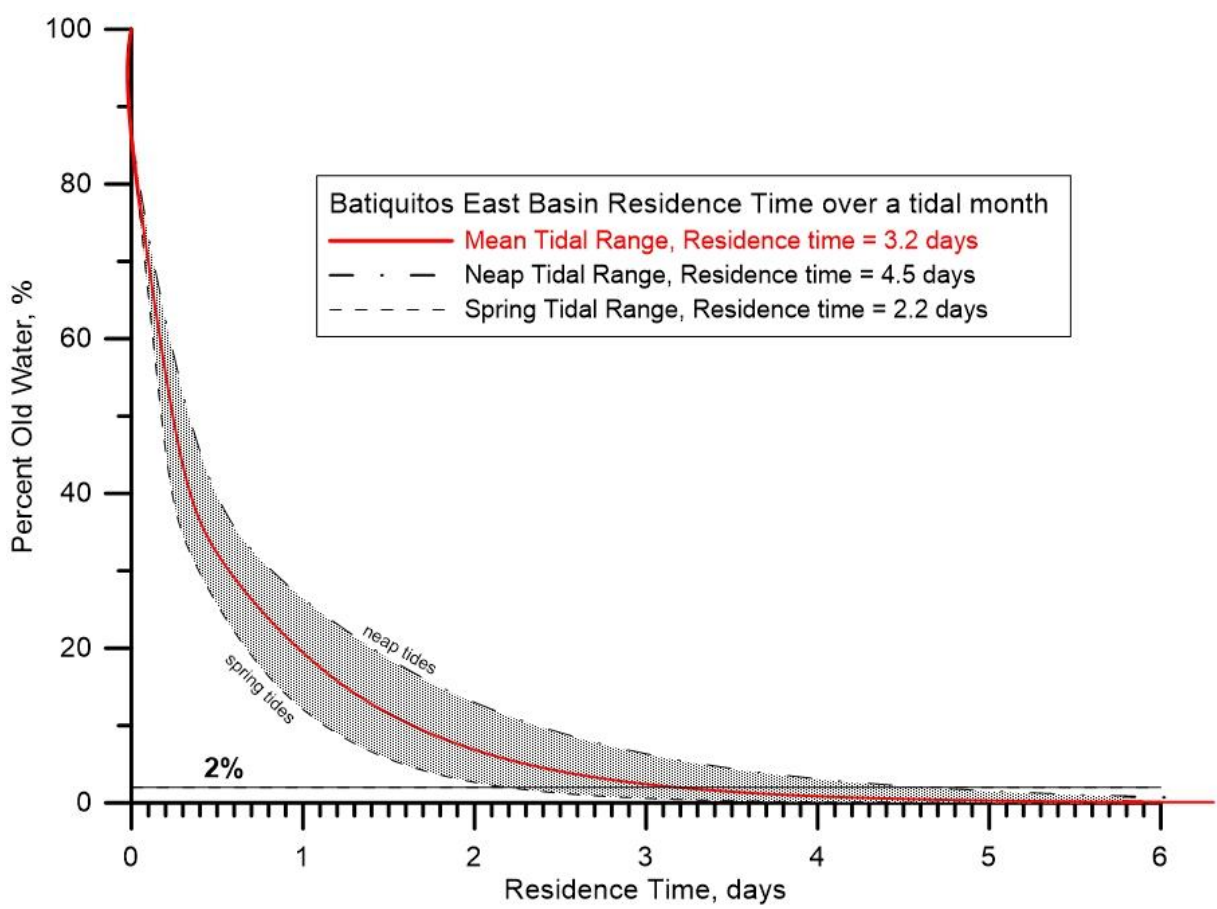
---

\*Note, lagoon salinity is calculated from the Ocean Plan definition of dilution factor using the equation:

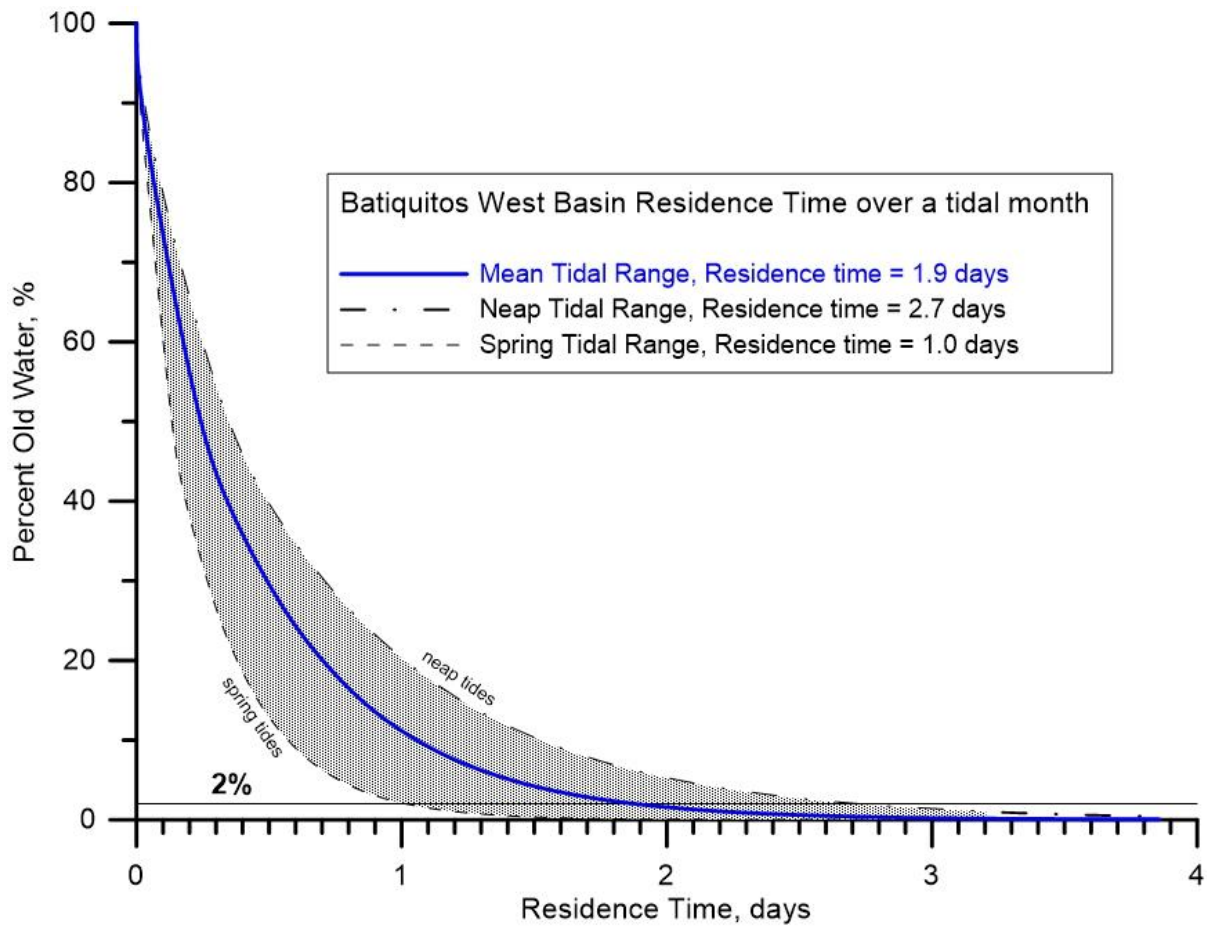
$$S_{lagoon} = S_0 - \frac{S_0}{D_m + 1} \quad (2)$$

where  $S_0 = 33.52$  ppt is ambient ocean salinity and the salinity of the runoff is assumed to be 0 ppt





**Figure 15.** Variation of residence time with tidal range in East Basin of Batiquitos Lagoon



**Figure 16.** Variation of residence time with tidal range in West Basin of Batiquitos Lagoon

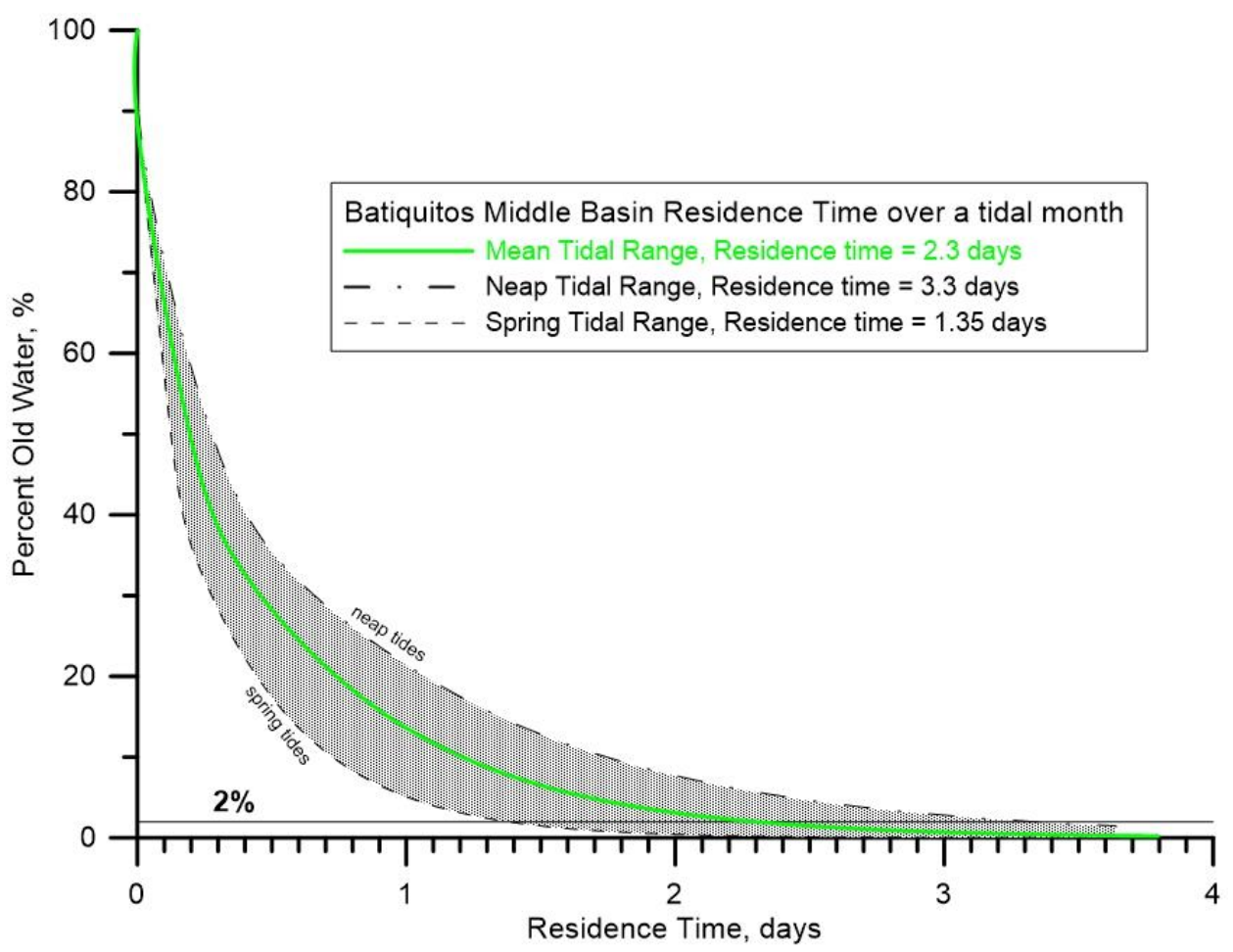


Figure 17. Variation of residence time with tidal range in Middle Basin of Batiquitos Lagoon

The scenario outlined above would be the absolutely worst-case dilution scenario because the entire 100-yr run-off volume of the HWY 101-East storm drain will not remain confined to the West Basin for nearly 2 days. The circulation patterns modeled in Figure 12 & 13 clearly indicate the runoff water mass will spread into the other interior basins of Batiquitos Lagoon, where additional dilution will occur due to the additional storage volume in those basins. Assuming the 100-yr storm runoff discharged by the HWY 101-East storm drain is uniformly distributed throughout the entire lagoon system, the average volume of sea water available to dilute the runoff over one diurnal tide cycle increases to 2,160 acre ft. This increases the dilution factor of the HWY 101-East storm drain discharge to  $D_m = 318.6$  to 1; and the resulting incremental salinity depression occurring throughout the lagoon from this particular storm drain would be only -0.1 ppt, reducing lagoonal salinity from 33.52 ppt, down to 33.51 ppt. Naturally there are other sources of storm runoff throughout Batiquitos Lagoon, but the incremental impact from the HWY 101 storm drain in isolation would only result in lowering lagoon salinity by -0.1 ppt, which is within measurement error of a calibrated conductivity-temperature-depth (CTD) sensor. This minor impact on lagoon salinity would vanish in at most 3.2 days under average conditions, and within 4.5 days under worst-case neap tide conditions (cf East Basin residence times, Figure 15)

### 6. Sedimentation from 100-yr Storm Discharges from the HWY-101-East Storm Drain

Our calculations are based on the assumption of steady-state sedimentation processes for which the well-known deposition flux equation after Cole and Miles, (1983) can be integrated over time,  $t = T$ , to give the deposition thickness,  $\eta(T)$ , given by:

$$\eta(T) = \frac{K_s C_0 Q_R}{2C_s A_B} T \quad (3)$$

Here, the suspended load of the HWY 101-East storm drain is assumed to have a very high worst-case concentration of  $C_0 = 220$  mg/L;  $C_s$  is the sediment concentration of partially consolidated mud equal to  $C_s = 200$  g/L, where  $A_B = 23.94$  acres is the area of the West Basin;  $Q_R = 2.8556$  cfs is the average discharge rate from the HWY 101-East storm drain and  $K_s$  is the sedimentation coefficient. For worst-case assessment we use the West Basin residence time  $T = 1.9$  days. Cole and Miles, (1983) invoked a sedimentation coefficient based on earlier work by Fujita, (1962), who derived a formulation based on sediment settling velocity,  $w_0$ , and the fraction of suspended sediment,  $N$ , that has settled out of the water column according to:

$$K_s = \frac{N w_0 h}{\varepsilon} \quad (4)$$

Where  $h = 5.5$  ft is the average depth of water in the West Basin over one diurnal tide cycle, and  $\varepsilon = 2.15 \times 10^{-2}$  cm<sup>2</sup>/s is the mass diffusivity of fine grained sediments as determined from field measurements by Jenkins and Wasyl, (1990) and Jenkins et al., (1992). The size of flocs formed when the storm water mixes with the lagoon water depends on the salinity of these two water masses. We will adopt the worst-case scenario from Section 6 above and assume all of the storm water remained

contained in the West Basin, whence West Basin salinity is 31.54 ppt. Two micron size clay particles in the storm water will flocculate to form 31.2 micron size floc particles once exposed to 31.54 ppt salinity in the settling basins, and will settle at an accelerated velocity of  $w_0 = 0.087$  cm/s (cf. Figure 18).

In equation (4) the fraction of suspended sediment,  $N$ , that has settled out of the water column is a shape dependent factor. The more rapidly the well-mixed, combined flow diverges and decelerates as it enters the West Basin, the greater the percentage of suspended load that will settle out of the water column. Flow divergence is most effective in gap or box flows that rapidly expand and form dead-water areas and back-water eddies in the cross stream regions of the gap or box. Here the water mass residence time is greatest, and the suspended load has the longest period time to fall out of the water column. This flow behavior is supported in box or gap flows with small aspect ratios. On the other hand, if the expansion of a gap flow or box flow is small, then flow divergence is weak, and the dead-water area in the cross-flow direction is greatly diminished. Consequently, a smaller fraction of sediment falls out of the water column, while the majority of the suspended load passes through the gap or box. This type of behavior occurs with high aspect ratio geometries when the box or gap configuration becomes essentially a long narrow channel. With these general remarks in mind, a series of computational fluid dynamics (CFD) experiments were performed by Jenkins (2018). The variation in cross-stream to streamwise velocities obtained in these numerical experiments were applied to the field measurements of sedimentation rates measured in jet-flow types of field experiments by Jenkins et al. (1992) to produce the following empirical relation:

$$N = N_0 h \sqrt{\frac{R_A + k_0}{A_B}} \quad (5)$$

where  $N_0$  is the desired capture efficiency of the box (set equal to unity for worst-case), and  $k_0$  is a non-dimensional best-fit parameter equal to  $k_0 = 0.11$ . The length of the box in the streamwise direction between the inflow and outflow is  $L$ , and the width of the box in the cross-stream direction is  $Y$ , so that the length to width ratio, referred to as aspect ratio,  $R_A$ , given by:

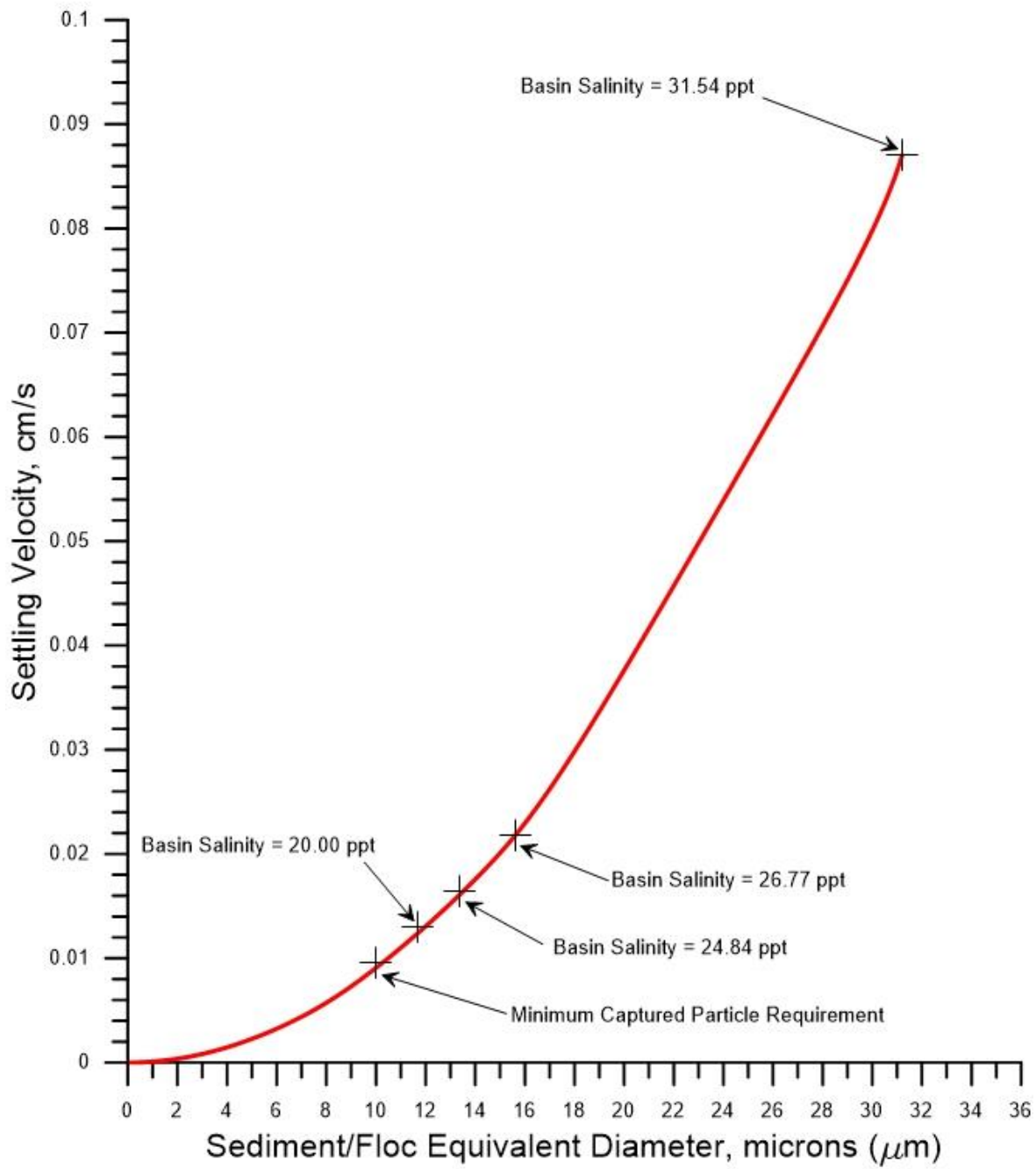
$$R_A = \frac{L^2}{A_B} = \frac{A_B}{Y^2}$$

For the West Basin of Batiquitos Lagoon the aspect ratio is  $R_A = 5.62$  (cf. Figure 2). Inserting equations (4) & (5) into equation (3) we solve for the thickness sediment deposition in the West Basin following 100-yr event runoff from the HWY 101-East storm drain,  $\eta$ , according to

$$\eta = (R_A + k_0)^{1/2} \left( \frac{N_0 w_0 C_0 Q_R T h^2}{\varepsilon C_s A_B^{3/2}} \right) \quad (6)$$

**Settling Velocity vs Sediment and Floc Size  
for potential ranges of settling basin salinity**

— Based on Sverdrup et al., (1942); Ajaz & Jenkins, (1993)



**Figure 18:** Variation in the settling velocity of clays and flocculated fine-grained sediment as a function of equivalent spherical particle diameter, after Sverdrup et al., (1942); Ajaz & Jenkins, (1993).

The following are the parameter selections used in equation (6) for estimating worst-case sedimentation in the West Basin of Batiquitos Lagoon due to 100-yr event runoff from the HWY 101-East storm drain:

$$\begin{aligned}
 Q_R &= 2.8556 \text{ cfs} = 80,862.43 \text{ cm}^3/\text{s} \text{ (HWY 101-East storm drain average discharge rate)} \\
 h &= 5.5 \text{ ft} = 167.64 \text{ cm} \text{ (West Basin average depth)} \\
 C_0 &= 220 \text{ mg/L} = 0.00022 \text{ g/cm}^3 \text{ (HWY 101-East storm drain suspended sediment concentration)} \\
 C_s &= 200 \text{ g/L} = 0.2 \text{ g/cm}^3 \text{ (concentration of consolidated mud)} \\
 T &= 164,160 \text{ s} \text{ (West Basin residence time)} \\
 N_0 &= 1.0 \text{ (worst-case suspended sediment capture efficiency)} \\
 w_0 &= 0.08703 \text{ cm/s} \text{ (for West Basin salinity} = 31.54 \text{ ppt)} \\
 \varepsilon &= 0.0215 \text{ cm}^2/\text{s} \text{ (diffusivity of suspended sediment)} \\
 k_0 &= 0.11 \text{ (empirical best-fit parameter)} \\
 R_A &= 5.62 \text{ (West Basin aspect ratio)}
 \end{aligned}$$

Based on these parameters, the 100-yr event runoff event from the HWY 101-East storm drain will produce  $\eta = 0.13$  cm of deposition of partially consolidated mud in the West Basin of Batiquitos Lagoon. This is certainly a *di minimis* amount of post-storm deposition, especially considering it is based on under worst case assumptions that all storm water discharged from the HWY 101-East storm drain remains confined within the West Basin over a 1.9 day period.

## 7) Conclusions:

A finite element hydrodynamic model was used to address potential water quality, erosion and sedimentation impacts to Batiquitos Lagoon due to incremental net additions of new storm water associated with infrastructure improvements along North Coast Highway 101 within the City of Encinitas. The study focuses on the largest of these improvements, the HWY 101-East storm drain with its associated dissipator structure. Discharges from this storm drain will runoff across vegetated high-tide refugia and into the south arm of the West Basin of Batiquitos Lagoon. The modeling utilized updated bathymetry provided by Merkel and Associates, (2008) and latest updates to Scripps Pier NOAA tides for the 1983-2001 tidal epoch. The model was calibrated to within 0.1 foot accuracy in predicted lagoon water levels.

**Findings for potential Erosion Impacts:** During flood tide, a sluggish disorganized eddy persists in the south arm of the West Basin in which velocities range from 0.02-0.04 m/s (0.06 – 0.13 ft/s), far below the threshold of motion of the native West Basin sands. Scour of these lagoon sands occurs at speeds of 0.8 ft/sec (0.24 m/sec). Similarly, on ebb tide, the south-arm currents in the West Basin do not exceed - 0.1 m/sec (-0.3 ft/sec), or 2.4 times smaller than threshold scour speed. Scour across the vegetated high tide refugia from the discharges of the HWY 101-East storm drain are also equally unlikely since the dissipator is designed to lower discharge velocities below 1 ft/s (the threshold scour speed of the sandy soils across the high tide refugia)

**Findings for Dilution and potential Salinity Depression Impacts:** Discharges into the West Basin of Batiquitos Lagoon from the HWY 101-East storm drain due to runoff from the 100-yr storm are calculated to yield 295,455 ft<sup>3</sup> (6.78 acre-ft) in a 28.74 hour period (1.16 diurnal tide cycles). The average

volume of sea water stored in the West Basin over one diurnal tide cycle is 108 acre ft. Using the definition of dilution factor  $D_m$  under the California Ocean Plan ( $D_m$  = parts seawater per parts effluent), the storm runoff discharged by the HWY 101-East storm drain during a 100-yr event could not be any less than  $D_m = 15.9$  to 1, assuming all of the storm water remained contained in the West Basin. In that case the salinity in the West Basin would be depressed by -1.98 ppt from 33.52 ppt for ambient seawater, down to 31.54 ppt. However, that amount of salinity depression would be a short-lived occurrence. After 1.9 days following session of runoff from the HWY 101-East storm drain (equivalent to West Basin residence time) the dilution factor would increase to no less than  $D_m = 796$  to 1. Consequently, salinity in the West Basin would increase to 33.48 ppt, a mere -0.4 ppt below ambient sea water.

**Findings for potential Sedimentation Impacts:** The 100-yr event runoff event from the HWY 101-East storm drain are calculated to yield 0.13 cm of deposition of partially consolidated mud in the West Basin of Batiquitos Lagoon. This is certainly a *di minimis* amount of post-storm deposition, especially considering it is based on worst case assumptions that all storm water discharged from the HWY 101-East storm drain remains confined within the West Basin over a 1.9 day period.

## 8) References:

- Aijaz, S. & S. A. Jenkins, 1993, "Dynamics of shearing in flocculating fine sediment suspension," *Makromol. Chem.*, v. 76, p. 89–93.
- Cardno ENTRIX, et al., 2014, "Basis of design report: Species Conservation Habitat", DWR Proj. No. 4600008734, 14 April 2014, 37 pp.
- Cole, P. and G., V., Miles, 1983, "Two-dimensional model of mud transport and deposition", *Jour. Hydraulic Eng.*, ASCE, vol. 109, no. 1, pp. 1-12.
- Connor, J. J. and J. D. Wang, 1973, "Finite element modeling of two-dimensional hydrodynamic circulation," MIT Tech Rpt., #MITSG 74-4, p. 1-57
- Fujita, H., 1962, *Mathematical Theory of Sedimentation Analysis*, York: Academic, 315 pp.
- Gallagher, R. H., 1981, *Finite Elements in Fluids*, John Wiley & Sons, New York, 290pp.
- Jenkins, S. A. & D. L. Inman, 1999, "Sand transport mechanics for equilibrium tidal inlets," *Shore & Beach* (Magoon Volume, Jan 99), v. 67, n. 1, p. 53–58.
- Jenkins, S. A. & J. Wasyl, 1990, "Resuspension of estuarial sediments by tethered wings," *Jour. Coastal Res.*, v. 6, n. 4, p. 961–980.
- Jenkins, S. A., S. Aijaz & J. Wasyl, 1992, "Transport of fine sediment by hydrostatic jets," *Coastal and Estuarine Studies, American Geophysical Union*, v. 42, p. 331–347.



Jenkins, S. A., M. Josselyn & J. Wasyl, 1999, Hydroperiod and Residence Time Functions for Habitat Mapping of Restoration Alternatives for San Dieguito Lagoon, submitted to *Southern California Edison Co.*, 30 pp. + 1 appen.

Jenkins, S. A. and J. Wasyl, 2005, "Coastal evolution model," Scripps Institution of Oceanography Tech. Rpt. No. 58, 179 pp. + appendices. <http://repositories.cdlib.org/sio/techreport/58/>

Jenkins, S. A., 2018, "CFD Analysis of New River Trash Screen and Diversion Structures," submitted to the California State Water Resources Control Board, submitted by Michael Baker International, San Diego, 43 pp.

Josselyn, M. & A. Whelchel, 1999, Determining the Upper Extent of Tidal Marsh Habitat San Dieguito Lagoon, submitted to *Southern California Edison Co.*, 16 pp.

Merkel, 2008, Batiquitos Lagoon Long-term Biological Monitoring Program Final Report, 2.0 Physical Evolution, submitted to Port of Los Angeles, 47 pp.

NOAA, 2013, "Verified/Historical Water Level Data" <http://tidesonline.nos.noaa.gov>

Sverdrup, H. U., M. W. Johnson and R. H. Fleming: 1942, *The Oceans*, Prentice-Hall, Englewood Cliffs, N. J., pp 1087.

Wang, P. F., Cheng, R. T., Richter, K., Gross, E. S., Sutton, D., and Gartner, J. W. (1998). "Modeling Tidal Hydrodynamics of San Diego Bay, California." *J. Amer. Water Res. Assoc.*, 34 (5), 1123-1140.

Weiyan, T., 1992, *Shallow Water Hydrodynamics*, Water & Power Press, Hong Kong, 434 pp.

Zedler, J. B. & G. W. Cox, 1985, "Characterizing wetland boundaries: a Pacific Coast example," *Wetlands*, 4, p. 43-55.

# APPENDIX B

*Q3 Memorandum*

*L101 Project Water Quality Model Analysis*



## MEMORANDUM

**To:** Joanne Tyler

JN 40.046.000

**From:** Tom Ryan

**Date:** May 20, 2020

**Subject:** L101 Project Water Quality Model Analysis

---

This memo provides a summary of the water quality evaluation of the area tributary to the L101 Streetscape project to support the project CEQA document. The purpose of this study is to evaluate the impact of the project and its proposed “green infrastructure” on the peak flow and volume of water quality runoff per the definition identified in the NPDES permit.

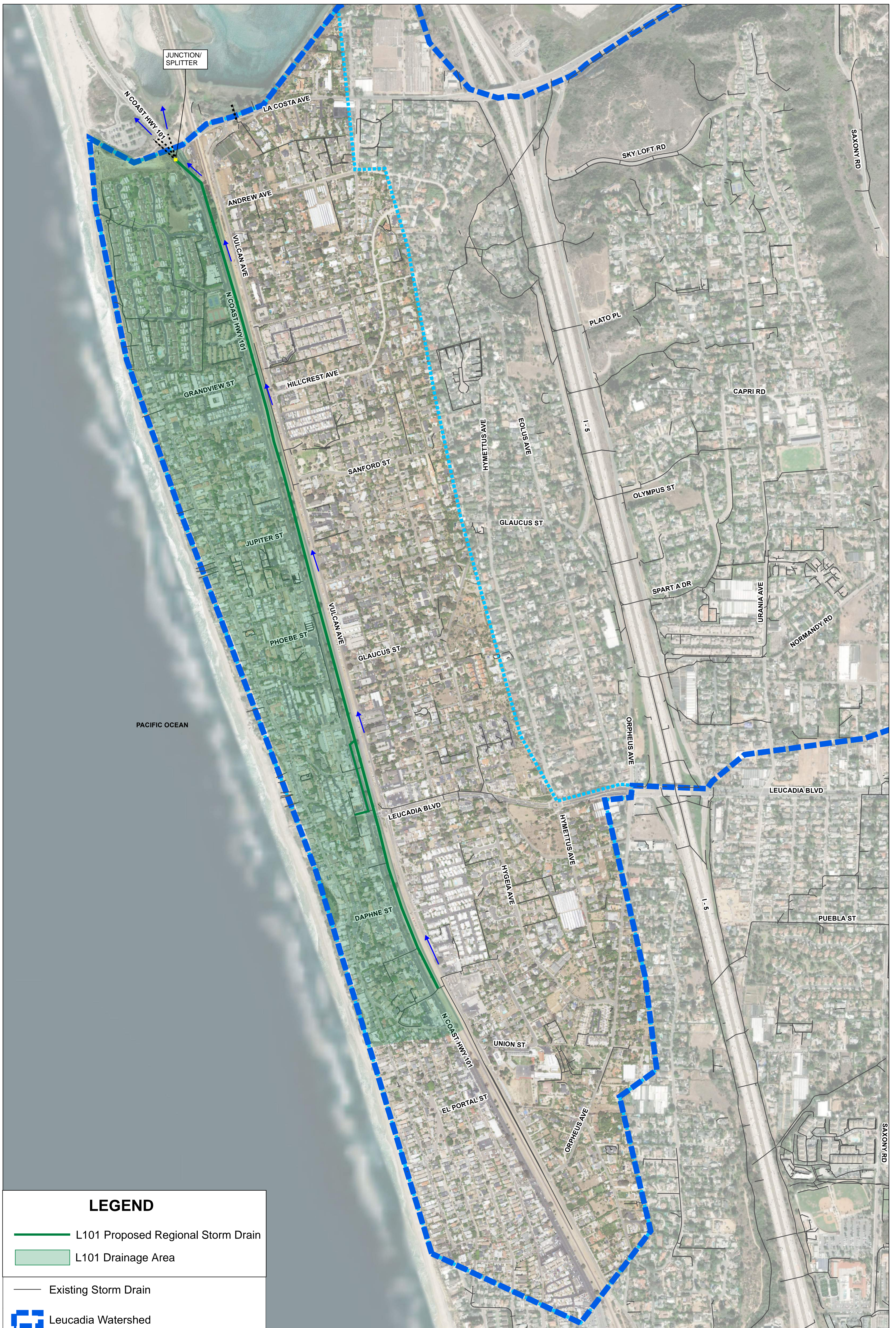
### Introduction

The City of Encinitas hired the engineering services of Q3 Consulting to prepare a regional Master Plan of Drainage (MPD) for the Leucadia and Old Encinitas watershed areas. This master plan involves using an advanced urban watershed hydrologic and hydraulic model to evaluate and identify flood protection and “green infrastructure” opportunities within each watershed. Concurrently, Michael Baker International is providing services for the design of the L101 Streetscape project for a portion of the North Coast Highway that lies within the Leucadia watershed.

As part of the MPD, the City requested a detailed model and analysis be prepared for the L101 area to coincide with the planning and design of the L101 Streetscape project. Q3 developed a regional drainage solution for the area and identified it as one of the Master Plan priority projects. Once the models were completed, Q3 was requested to evaluate the water quality storm event, in support of the L101 Streetscape project.

#### Existing Storm Drain System

The proposed regional system for the L101 area consists of approximately 8,000 linear feet of HDPE pipe ranging from 42-inch to 60-inch in diameter. This storm drain was designed to convey the 100-year design storm for the 200 acre area immediately tributary to North Coast Highway, which is generally bound by the NCTD railroad tracks to the east, La Costa Avenue to the north, El Portal Street to the south, and Neptune Avenue to the west. The proposed storm drain will replace the existing 24-inch drain pipe currently located along the North Coast Highway (including the pump station at Phoebe Street) and discharges near Ponto Beach in a series of detention basins.



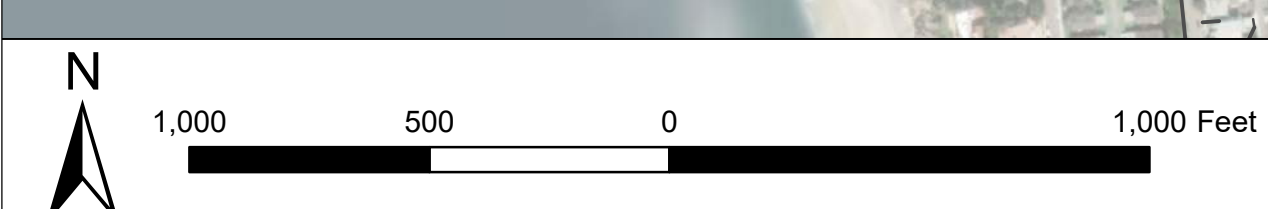
**LEGEND**

- L101 Proposed Regional Storm Drain
- L101 Drainage Area

Existing Storm Drain

Leucadia Watershed

North Coast Hwy / Vulcan Ave Watershed



**Figure 1: L101 Hydrology Boundary**

The existing system currently discharges to the Ponto basins along the west side of North Coast Highway near Ponto Beach. The outlet consists of two discharge pipes, the 24-inch RCP and an 18-inch concrete pipe. The 18-inch pipe used to be a discharge pipe for the Phoebe Street Pump station. The City performed a CCTV inspection of this line and identified that it currently drains a portion of the southbound lanes along the Hwy. This 18-inch pipe has several connections to the existing 24-inch line so the systems can communicate or share discharges.

A third discharge pipe is located on the east side of North Coast Highway. This 24-inch outlet serves mainly the area surrounding the intersection of La Costa Avenue and the Highway. This outlet is currently separate from the main outlet of the L101 area.

The two main outlets discharge into a small detention basin, that is routed under the Ponto Beach entrance road to a second basin. The second basin contains a culvert that outlets to the North Coast Highway median, where it is conveyed via a vegetated channel to the Batiquitos Lagoon at the Hwy. bridge overpass.



**Figure 2: L101 Area Existing Storm Drain Outfalls**

As can be seen in Figure 2, the existing runoff from the L101 ultimately discharge into the Batiquitos Lagoon.

#### Project Outfall – Batiquitos Lagoon

The Batiquitos Lagoon has a tributary drainage area over 85 square miles, or approximately 54,500 acres. The L101 project area, also tributary to the Lagoon, consists of 200 acres. Recent modifications to the existing 24-inch La Costa outfall drains another three (3) acres to the east side of the lagoon. The proposed storm drain connects these two outfall locations, but only access the La Costa outfall in larger storm events by way of a diverting all smaller storms to the west.

### L101 Streetscape Project

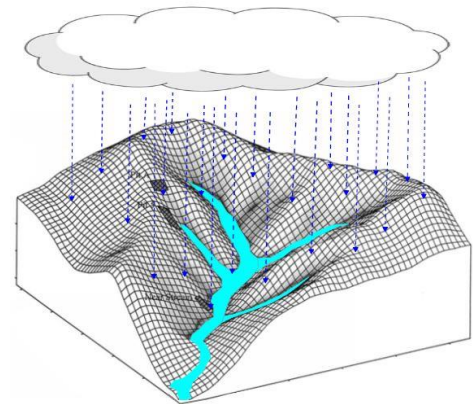
Michael Baker International has developed Final Design Plans for the L101 Streetscape project, which include “green infrastructure” to reduce the directly connected impervious area, as well as, provide water quality treatment for the proposed project improvements.

### Study Objective

Per the ongoing Leucadia Master Plan, a proposed drainage system was identified to implement as part of the L101 Streetscape project. The goal of the drainage system was to mitigate flooding for the 100-year storm for the area tributary to the Streetscape project. This study evaluates the peak runoff and volumes for the “first flush” or the industry standard 85-percentile/24-hour storm event as defined in the San Diego County NPDES Permit and adopted by U.S. EPA. A comparison will be made between the existing condition and the proposed condition.

## Hydrology

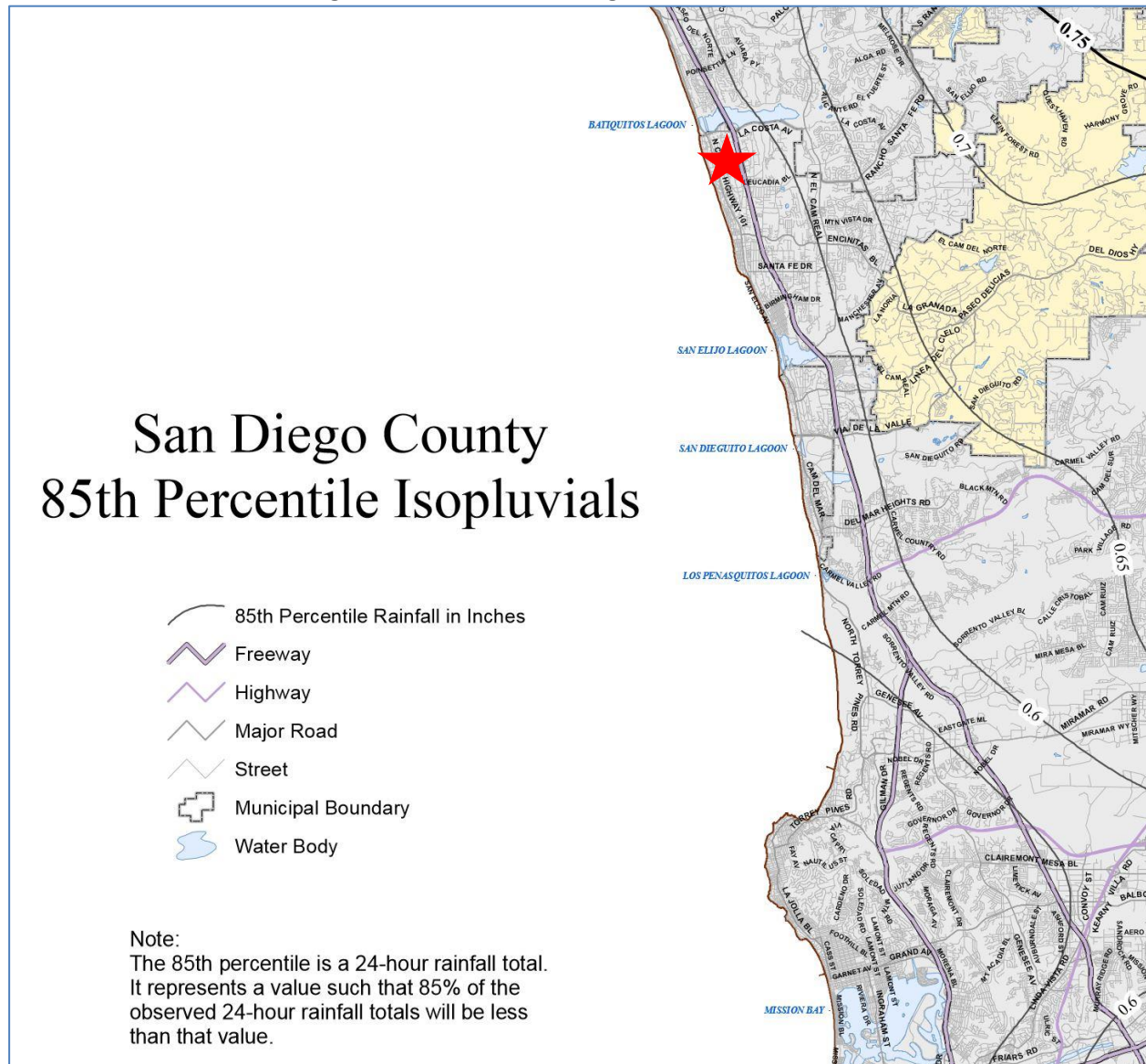
Water quality hydrology was performed using rain-on-grid, similar to the methods used in developing the Master Plan of Drainage. Rain-on-grid, or distributed rainfall allows for direct application of precipitation on the 3-Dimensional surface. The rainfall was developed based on the 85<sup>th</sup> Percentile/24-hour point rainfall identified in the San Diego County Water Quality Technical Design Manual. A distribution pattern was used from NOAA 14, for a 2-year storm event, which is a “nested” storm pattern or worst-case scenario. Net rainfall was calculated from the original precipitation by subtracting the rainfall losses, using the guidelines in the San Diego Hydrology Manual. This method allows for the model to establish flow paths based on land uses and topography. No longer is “time-of-concentration”, or lag needed to develop hydrographs. This approach was used in the MPD for the larger storm events.



*Example of Rain-on-Grid Hydrology*

The depth used for the 85-th percentile/24-hour storm event of **0.56”** was based on the San Diego County 85<sup>th</sup> Percentile Isopluvials Map (Figure 3). Loss rates were calculated based on land-uses and precipitation applied to the XPStorm 2-dimensional surface via distributed rainfall. Runoff from the surface are transported to the subsurface 1-dimensional storm drain through catch basins or inlets. This model was performed for both existing conditions and proposed project conditions.

Figure 3: L101 Area Existing Storm Drain Outlets



For the project conditions, the proposed graded surface was appended to the existing surface. The new surface includes the new proposed grading and new Streetscape roadways and green infrastructure. As part of the L101 Streetscape project, several bio retention areas were implemented, which were accounted for in the model. These locations were modeled by placing the footprints of each facility in the surface and subtracting the depths (depths of filter) to account for the storage potential. The depth used in this model were 2-feet.

## Hydraulic Modeling

Q3 Consulting developed hydraulic models using Innovyze's XPStorm software. XPStorm is an advanced 1-dimensional/2-Dimensional hydraulic model capable of evaluating surface flows in multiple directions. The model also evaluates subsurface flows (storm drains) simultaneously, providing the ability to model complex hydraulic scenarios. This model was used for the water quality storm event evaluation assuming the existing 24-inch valve at the RCP site is in the open position, allowing flows to be conveyed to the existing 24-inch pipe from the Union Street area.

Hydraulic models were performed for the following scenarios:

- 1) WQ Storm Existing Conditions
- 2) WQ Storm Project Conditions – Model includes proposed L101 Streetscape grading, drainage infrastructure, and green infrastructure.

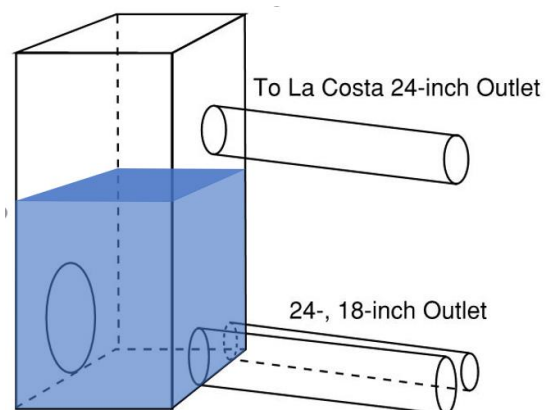
### Scenario 1

The existing conditions model outlet into the Ponto Beach basins includes two pipes; a non-reinforced concrete 18-inch pipe, and a 24-inch reinforced concrete pipe (RCP). For purposes of comparison, the outlet characteristics for this evaluation were taken as the sum of the two pipes. For example, the peak flow and volume for each pipe was added, since the two pipes are actually connected upstream. The study focuses on this location, to compare the outlet of the system to the open area.

### Scenario 2

The project condition storm drain is designed to mitigate flooding for the 100-year storm event for the tributary area to the L101 project north of Basil Street and west of the NCTD railroad tracks. The outlet is designed as a junction box, where flows are split into three smaller outlet pipes. Two of the pipes that lead to the Ponto Beach basins, will utilize the existing 18-inch and 24-inch outlet. Another smaller outlet pipe (24-inch) leads to the existing Batiquitos Lagoon outfall located near La Costa Avenue. All three of these outlets are existing and will be connected to as part of the proposed project.

The junction box, or splitter structure, discharges the two Ponto Beach pipes at the same invert as the inflow 60-inch proposed pipe. The 24-inch outlet pipe to Batiquitos Lagoon resides 10 feet higher. In other words, flow depths in the junction would have to reach a depth of 10 feet before the third outlet starts discharging. Figure 3 shows the general configuration at the outlet junction (splitter) box.



**Figure 3: Schematic of Splitter Structure**



## Results

The focus of this study is the peak water quality flow and volumes discharged from the project site. A comparison of Scenario 1 (Existing Conditions) and Scenario 2 (Project Conditions) is presented below:

### Scenario 1:

**Table 1: Existing Conditions Water Quality (85<sup>th</sup> Percentile/24-hr) Model Results**

Outlet Pipe	Peak Flowrate (cfs)	Peak Velocity (fps)	Total Volume (cf)
18-Inch	3.1	6.1	36,033
24-Inch	4.5	9.2	45,495
24-Inch (East Outfall)	0.2	4.3	601
<b>Total</b>	<b>7.8</b>	-	<b>82,129</b>

For the existing conditions, a combined peak flowrate of 7.8 cfs was identified and a maximum velocity of 9.2 fps. Since both flows discharge to the same headwall, we are looking at the highest concentrated velocity for comparison. The volume of the water quality discharge, or defined “first flush” was 82,129 cf or 1.89 ac-ft.

### Scenario 2:

The proposed condition model incorporates a new outfall. Or, more accurately, it introduces a third outfall for the main line. This third inlet was set 10 feet above the other two inlets, which means the water quality storm runoff never reaches it. The maximum water surface elevation in the junction/splitter structure was found to be 0.48 feet, 9.5 feet below the third outlet invert.

**Table 2: Project Conditions Water Quality (85<sup>th</sup> Percentile/24-hr) Model Results**

Outlet Pipe	Peak Flowrate (cfs)	Peak Velocity (fps)	Total Volume (cf)
18-Inch	2.3	5.2	29,955
24-Inch	2.8	5.4	35,935
24-inch Diversion Pipe to East Outfall	0	0	0
24-Inch (East Outfall)	0.3	2.7	1,876
<b>Total</b>	<b>5.4</b>	-	<b>67,766</b>

The peak flowrate in the new proposed outlet to Ponto Beach basins is 5.4 cfs with a maximum velocity of 5.4 fps. The volume of the water quality discharge, or defined “first flush” was 67,766 cf or 1.56 ac-ft. This reduction in both peak flowrate, velocity, and volume is due to the volume capture of the green infrastructure.

## Conclusions

This study was intended to provide information regarding the potential water quality impacts of the project with respect to volume and peak discharge from the “first flush” storm event, as defined by the

San Diego County Regional Water Quality Control Board and adopted by U.S. EPA. The 85-percentile/24-hour storm event was used to establish a rain-on-grid analysis to identify the “first flush” storm runoff. The use of green infrastructure for the project reduced the runoff discharged to Batiqitos Lagoon. The peak “first flush” runoff was reduced by 31-percent, and total volume was reduced by 17-percent. The location of where the regional system first flush flows are discharged are the same for both existing and project conditions.

The third outlet, located at La Costa Avenue, does not receive any first flush discharge from the proposed mainline pipe due to the outlet pipe location within the junction/splitter structure. The invert of that pipe is several feet above the water quality depth in the junction. The 2-dimensional results for both existing and project conditions can be seen in Exhibits 1 and 2 for the 85-percentile/24-hour storm events. Additional inlets are proposed, as part of the Encinitas Beach Resort Project, at the intersection of La Costa and the North Coast Hwy, but no increase in pervious area is proposed. These additional inlets drain the immediate areas better than existing conditions and slightly increase the water quality flows to the La Costa outlet. It should be mentioned that the additional flows routed to the La Costa storm outlet (East Outlet), are currently being discharged via overland flow to the Batiqitos lagoon currently, effectively nullifying the incremental increase in total water quality runoff.

The two main project discharges, Ponto Beach basins and the La Costa outlet both eventually tie into the Batiqitos Lagoon. The Ponto Beach basins, discharge to the North Coast Highway median, where they are routed north and discharged at the Batiqitos Lagoon bridge crossing. The total project 85-percentile/24-hour storm peak flow and total volume discharges are reduced as a result of the proposed green infrastructure improvements within the L101 Streetscape project.

# EXHIBITS

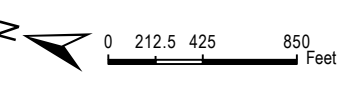


**Legend**

----- Existing Storm Drain

**Max Depth (ft)**

Dark Blue	0.25 - 0.5
Light Blue	0.5 - 1
Cyan	1 - 2
Yellow-Green	2 - 3
Orange	3 - 4
Red	>4



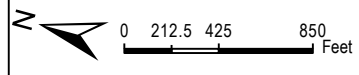


**Legend**

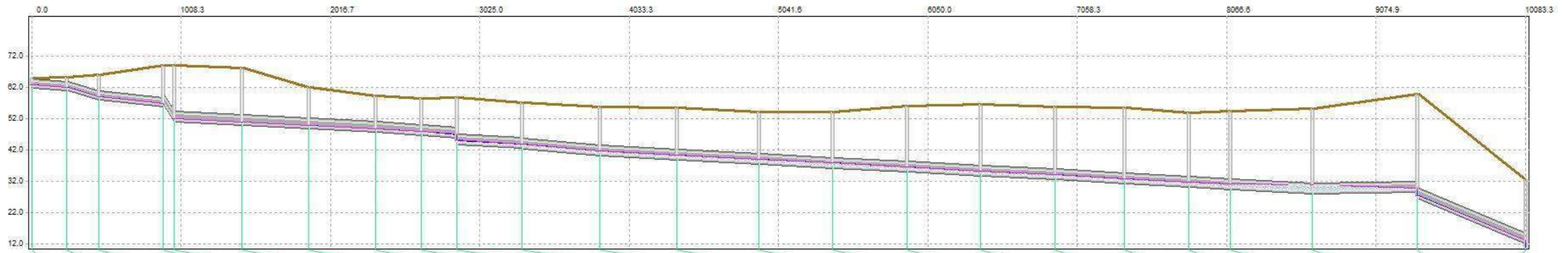
- Proposed Storm Drain
- - - Existing Storm Drain

**Max Depth (ft)**

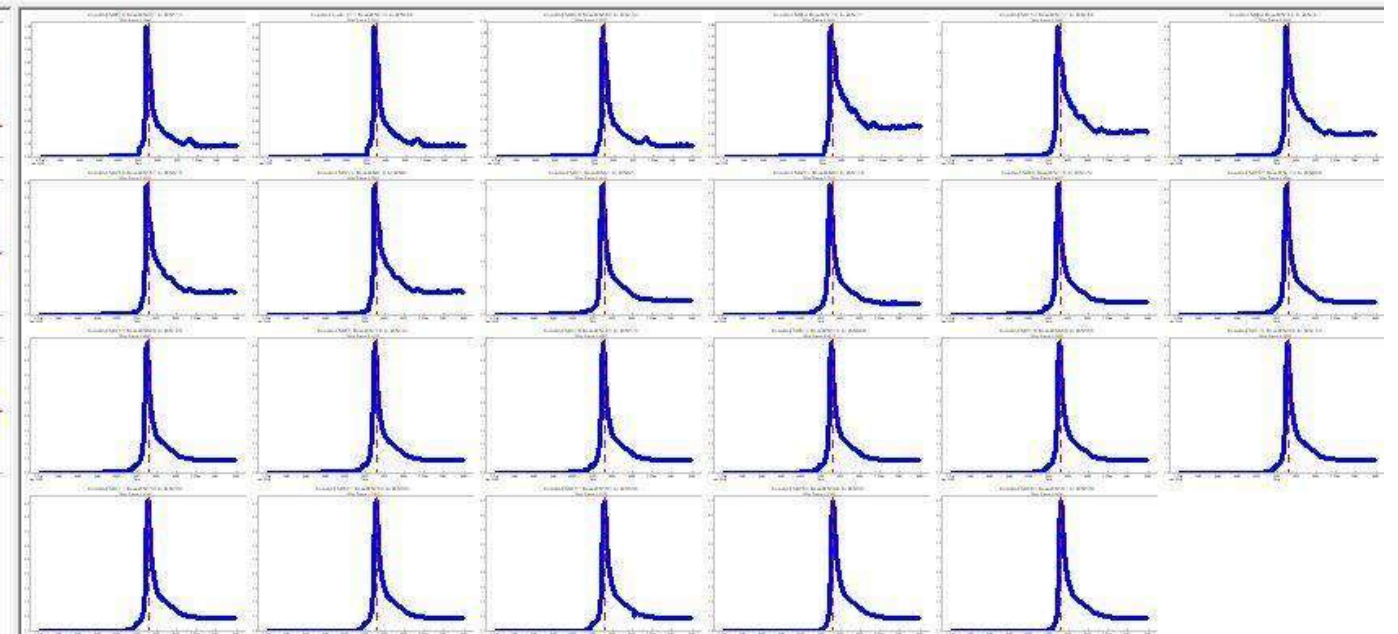
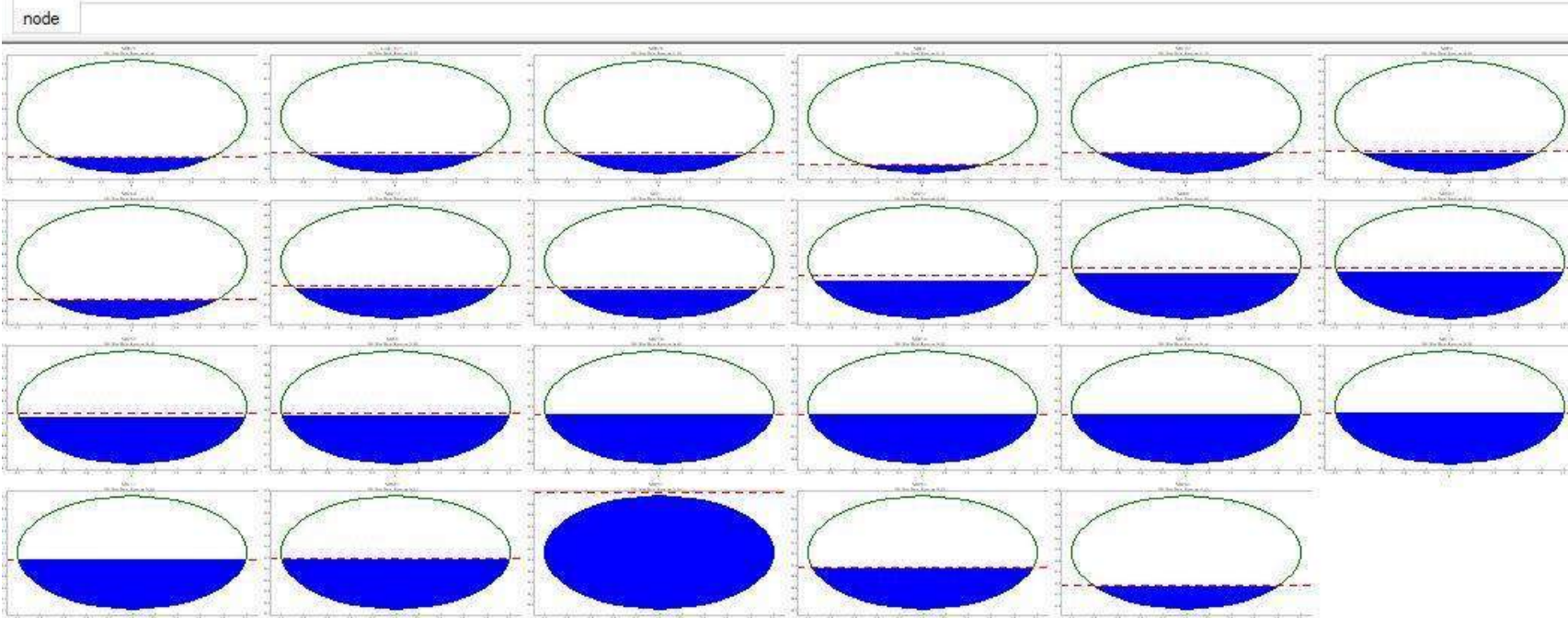
- 0.25 - 0.5
- 0.5 - 1
- 1 - 2
- 2 - 3
- 3 - 4
- >4



# EXHIBIT 3: Existing Conditions Profile and Sections



	JCN901	JCN573	JCN580	JCN130	JCN131	JCN166	JCN167	JCN414	JCN41	JCN42	JCN128	JCN129	JCN404	JCN104	JCN105	JCN370	JCN484	JCN306	JCN159	JCN200	JCN385	JCN346	JCN347	JCN394
Invert Elevatio	62.614	61.950	58.950	56.690	51.840	50.720	49.590	48.470	47.370	44.390	43.290	40.990	39.670	38.290	37.040	35.790	34.520	33.280	32.080	31.020	30.300	28.920	27.070	10.600
Node Name	JCN901	JCN573	JCN580	JCN130	JCN131	JCN166	JCN167	JCN414	JCN41	JCN42	JCN128	JCN129	JCN404	JCN104	JCN105	JCN370	JCN484	JCN306	JCN159	JCN200	JCN385	JCN346	JCN347	JCN394



# EXHIBIT 4: Project Conditions Profile and Sections

May [un] time 10:40:00 step 120000

link	SD820	Link1027	SD428	SD69	SD132	SD89	SD264	SD272	SD21	SD251	SD68	SD382	SD253	SD55	SD224	SD419	SD318	SD176	SD111	SD507	SD237	SD205	Link1895	4910.18	4910.24	
Conduit Slope	0.279	1.379	0.000	6.091	0.000	0.000	0.000	0.000	1.232	0.249	0.000	0.000	0.000	0.249	0.248	0.251	0.000	0.000	0.241	0.000	0.247	-0.044	1.967	2.370	2.370	
Roughness	0.014	0.013	0.013	0.013	0.013	0.013	0.013	0.013	0.013	0.013	0.013	0.013	0.013	0.013	0.013	0.013	0.013	0.013	0.013	0.013	0.009	0.009	0.014	0.014	0.014	
Natural Surface																										
Design Surface																										
Flow Direction	Free	Free	Free	Free	Free	Free	Free	Free	Free	Free	Free	Free	Free	Free	Free	Free	Free	Free	Free	Free	Free	Free	Free	Free	Free	
Shape	Circular	Circular	Circular	Circular	Circular	Circular	Circular	Circular	Circular	Circular	Circular	Circular	Circular	Circular	Circular	Circular	Circular	Circular	Circular	Circular	Circular	Circular	Circular	Circular	Circular	Circular

