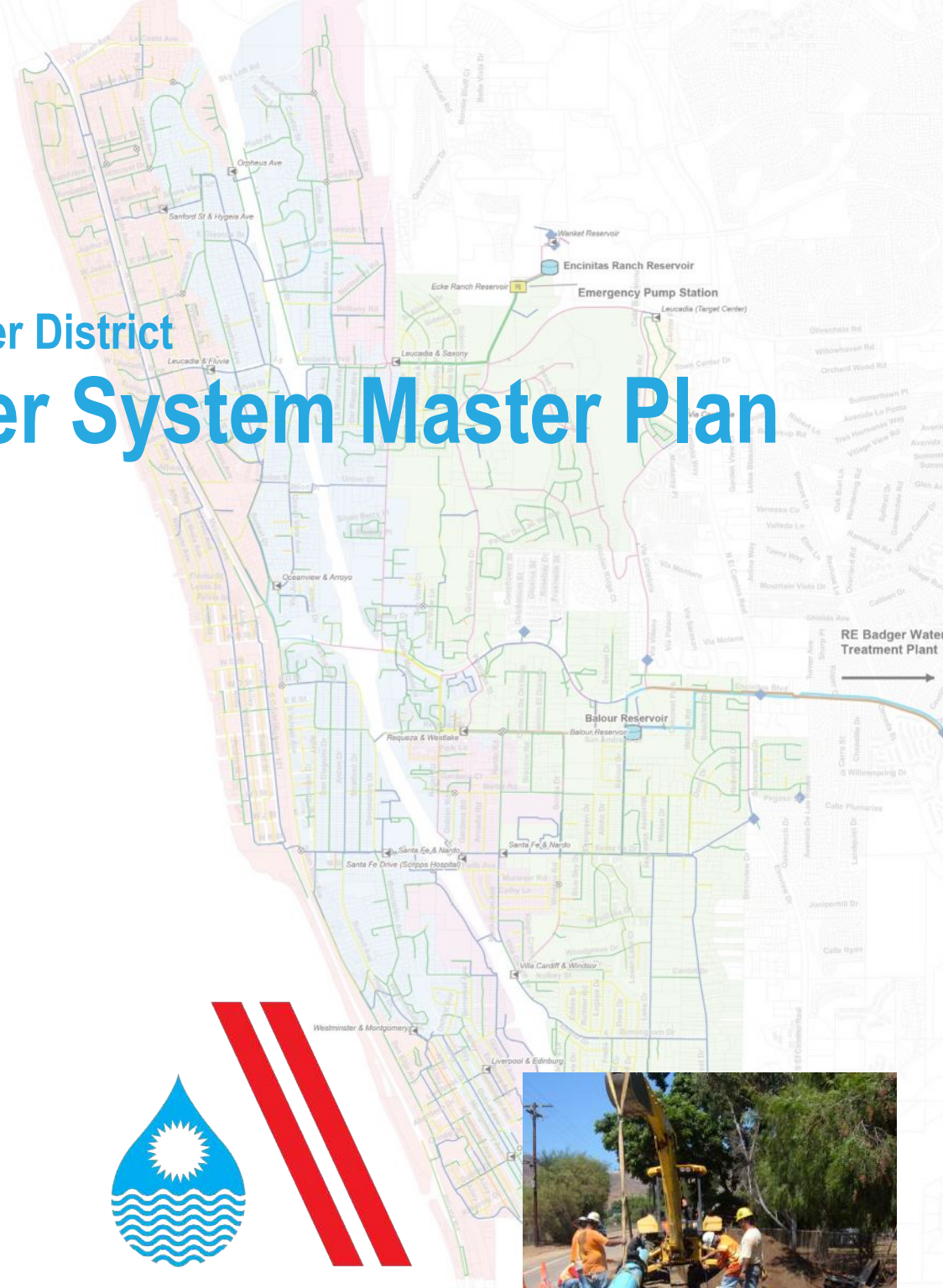


San Dieguito Water District 2022 Water System Master Plan FINAL

October 2021



Prepared by



in association
with



2022 Water System Master Plan

FINAL

Prepared for:



San Dieguito Water District
160 Calle Magdalena
Encinitas, CA 92024

October 26, 2021

Prepared by:



Table of Contents

Acronyms and Abbreviations	8
Executive Summary	1
<i>Existing Water System</i>	1
<i>Water Supply and Demand</i>	1
<i>Hydraulic Model Update</i>	1
<i>Hydraulic Evaluation</i>	1
<i>Asset Management Study</i>	2
<i>Capital Improvement Program (CIP)</i>	3
1. Introduction	8
1.1. <i>Background and Purpose</i>	8
1.2. <i>Scope of Work</i>	8
1.3. <i>Data Sources</i>	8
2. Existing Water System	9
2.1. <i>Service Area Description</i>	9
2.1.1. <i>Terrain and Climate</i>	9
2.2. <i>Water Distribution System</i>	9
2.2.1. <i>Tanks</i>	13
2.2.2. <i>Interconnects</i>	13
2.2.3. <i>Pipes</i>	14
2.2.4. <i>Pump Station</i>	16
2.2.5. <i>Pressure Reducing Valves</i>	16
2.2.6. <i>Recycled Water</i>	16
2.2.7. <i>SCADA</i>	16
3. Water Supply and Demand	19
3.1. <i>Historical Water Use</i>	19
3.2. <i>Large Water Users</i>	23
3.3. <i>Supply Sources</i>	27
3.4. <i>Water Use Trend</i>	27
3.5. <i>Existing Water Demands</i>	28
3.5.1. <i>Average Day Demand (ADD)</i>	28
3.5.2. <i>Max Day Demand (MDD)</i>	29
3.5.3. <i>Peak Hour Demand (PHD)</i>	29

3.5.4. Diurnal Pattern and Peaking Factors	29
3.6. <i>Future Demands</i>	30
3.6.1. Future Development	31
4. Design Criteria.....	34
4.1. <i>Distribution System Criteria</i>	34
4.2. <i>Fire Flow Criteria</i>	36
4.3. <i>Pump Station Criteria</i>	36
4.4. <i>Storage Criteria</i>	36
4.4.1. Operational Storage	37
4.4.2. Fire Flow Storage	37
4.4.3. In-District Emergency Storage	37
4.4.4. Reserve/Emergency Storage.....	38
5. Hydraulic Model Verification	39
5.1. <i>Model Description</i>	39
5.2. <i>Boundary Conditions</i>	39
5.3. <i>Operational Verification</i>	39
6. System Operations Assessment.....	42
6.1. <i>System Hydraulic Evaluations & Model Results</i>	42
6.1.1. Existing System Analysis.....	42
6.1.2. 2040 System Analysis	51
6.2. <i>Storage Analysis & Operations Usage</i>	59
6.3. <i>Emergency Interconnects Analysis</i>	62
7. Asset Management Study.....	64
7.1. <i>System Inventory, Performance, & Replacement Cost</i>	67
7.1.1. System Inventory.....	67
7.1.2. Replacement Cost.....	68
7.1.3. Mainline Performance.....	69
7.1.4. Valve Performance	71
7.1.5. Service Performance	72
7.1.6. Cathodic Protection System Performance	73
7.2. <i>Budgeting for Aging Infrastructure</i>	73
7.2.1. Age-Based Pipeline Renewal Budget	73
7.2.2. Performance-Based Pipeline Renewal Budget	74
7.3. <i>Recommended Distribution System Projects</i>	76
7.3.1. Risk Assessment.....	77

7.3.2. Pipeline Replacement.....	77
7.3.3. Opportunistic AC Condition Assessment	83
7.3.4. Proactive Large Diameter Condition Assessment.....	84
7.3.5. Cathodic Protection, Appurtenances, and Contingency	84
8. Capital Improvement Recommendations	85
8.1. <i>Capital Improvement Program</i>	85
8.1.1. Capacity-Based Pipeline Improvements	85
8.1.2. Condition-Based Pipeline Improvements	85
8.1.3. Improvements Related to Water Age.....	90
8.2. <i>Phasing</i>	90
8.3. <i>Cost Estimates</i>	94
8.3.1. Unit Costs.....	94
8.3.2. Capital Costs.....	94

Figures

Figure 2-1. Service Area	10
Figure 2-2 Existing System	11
Figure 2-3 System Schematic	12
Figure 3-1. Historical Authorized Water Use	20
Figure 3-2. Large Water Users.....	26
Figure 3-3. Historical Water Supply and Demand	28
Figure 3-4. MDD Diurnal Pattern.....	30
Figure 3-5. Future Developments.....	32
Figure 5-1. Encinitas Ranch Reservoir Tank Level Model Validation	40
Figure 5-2. Balour Reservoir Tank Level Model Validation.....	41
Figure 6-1 Model Results for Existing Average Day Demand.....	43
Figure 6-2. Model Results for Existing Maximum Demand	45
Figure 6-3. Model Results for Existing Peak Hour Demand.....	46
Figure 6-4. Model Results for Existing Fire Flow Analysis	47
Figure 6-5. Model Results for Existing Water Age Analysis.....	49
Figure 6-6. Model Results for 2040 Average Day Demand	52
Figure 6-7. Model Results for 2040 Maximum Day Demand	53
Figure 6-8. Model Results for 2040 Peak Hour Demands	55
Figure 6-9. Model Results for 2040 Maximum Day Demand plus Fire Flow	56
Figure 6-10. Model Results for 2040 Water Age Analysis	58
Figure 7-1. District Break Rate History	65
Figure 7-2. Benchmarking of District Performance & Investment Levels	65
Figure 7-3. Summary by Investment Type by Cost.....	66
Figure 7-4. Potential for Salt Cracking.....	70
Figure 7-5. Potential for Shrink-Swell.....	71
Figure 7-6. Age Alone is a Poor Indicator of Pipe Condition and Remaining Useful Life	74
Figure 7-7. Benchmarking of District Performance & Investment Levels	75
Figure 7-8. District Break Rate History	76
Figure 7-9. Summary by Investment Type	76
Figure 7-10. Recommended Near Term Replacement Projects	78
Figure 7-11. Map of Project 1 – Edinburg & Cambridge	79
Figure 7-12. Map of Project 1 – 1957 AC Pipe East of Glen Park	81
Figure 7-13. Map of Project 3 – Arcadia Mainline.....	82

Figure 7-14. Map of Project 3 – Arcadia Mainline Condition Assessment..... 83

Figure 8-1. Proposed CIP Projects..... 86

Figure 8-2 Optional Improvements..... 93

Tables

Table ES-1. Proposed Capital Improvements 4

Table ES-2. Summary Capital Improvement Cost Estimates 7

Table 2-1. Existing Reservoir Information 13

Table 2-2. Emergency Interconnects 13

Table 2-3. District Pipe Inventory 15

Table 2-4. Existing Pump Station Information 16

Table 2-5. Pressure Reducing Valve Information 17

Table 3-1. Billed Water Use by User Type 21

Table 3-2 Billed Water Use by Meter Size..... 22

Table 3-3. Large Water Users in FY 2020 23

Table 3-4. Existing Average Day Demand 29

Table 3-5. Recommended Peaking Factors 30

Table 3-7. Known Future Developments 33

Table 4-1. Distribution System Criteria References..... 35

Table 4-2. District Fire Flow Requirements 36

Table 6-1. Existing Maximum Day plus Fire Flow Results Summary 48

Table 6-2. Existing Minimum Day Demand Water Age Results Summary 50

Table 6-3. 2040 Maximum Day plus Fire Flow Results Summary 54

Table 6-4. 2040 Maximum Day plus Fire Flow Results Summary 57

Table 6-5. Existing System Storage Capacity Analysis Results..... 60

Table 6-6. 2040 System Storage Capacity Analysis Results 61

Table 6-7. Emergency Interconnects Estimated Flow Capacities 63

Table 7-1. Summary of Recommended CIP Projects 67

Table 7-2. Current Water Pipe Replacement Cost 68

Table 7-3. Categorization of Main Breaks 69

Table 7-4. Categorization of Service Breaks 72

Table 7-5. Age Based Useful Life..... 73

Table 7-6. Opinion of Cost for Project 1 – Edinburg & Cambridge..... 80

Table 7-7. Opinion of Cost for Project 2 – 1957 AC Pipe East of Glen Park..... 81

Table 7-8. Opinion of Cost for Project 3 – Arcadia Mainline	83
Table 7-9. Optional Condition Assessment Projects.....	84
Table 8-1. Proposed Capital Improvements	87
Table 8-2. Low Priority Improvements (Optional)	91
Table 8-3. Short Segment Improvements (Optional)	92
Table 8-4. Pipeline Unit Costs.....	94
Table 8-5. Unit Costs for other facilities.....	94
Table 8-6. Summary Capital Improvement Cost Estimates	95
Table 8-7. Summary of Low Priority Improvement Costs Estimates	96
Table 8-8. Summary of Short Segment Improvement Costs Estimates	96
Table 8-9. Summary Capital Improvement Cost Estimates	98

Appendices

- Appendix A – Model Results Figures and Tables
- Appendix B – AC Pipe Deterioration
- Appendix C – Using Condition Data to Support Decision Making
- Appendix D – Corrosion of Metallic Pipe
- Appendix E – Large Metallic Pipe Condition Assessment Strategy
- Appendix F – Large AC Pipe Condition Assessment Strategy

Acronyms and Abbreviations

ADD	Average Day Demand
AF	Acre-Feet
CIP	Capital Improvement Program
EPS	Extended Period Simulation
FY	Fiscal Year
MDD	Maximum Day Demand
MDD + FF	Maximum Day Demand plus Fire Flow
mgd	Million Gallons per Day
MinDD	Minimum Day Demand
OMWD	Olivenhain Municipal Water District
PHD	Peak Hour Demand
SCADA	Supervisory Control and Data Acquisition
SDCWA	San Diego County Water Authority
SDR	San Dieguito Reservoir
SEJPA	San Elijo Joint Powers Authority
SFID	Santa Fe Irrigation District
SS	Steady State Simulation
REB Plant	R.E. Badger Filtration Plant
VHFHSZ	Very High Fire Hazard Severity Zone

Executive Summary

The primary objective of this Water System Master Plan Update (Master Plan) is to update San Dieguito Water District (District) potable water use characteristics and hydraulic model, evaluate the water system under various demand conditions, identify system improvements needed to accommodate existing and future demands, and recommend a Capital Improvement Program (CIP). This Master Plan is a tool for the District to help make decisions on implementing water system improvements in order to provide reliable and efficient water service to its existing and future customers. This Master Plan has a 20-year planning horizon till year 2040.

Existing Water System

The District's water service area encompasses approximately 9 square miles, serving communities of the western portion of the City of Encinitas (City) with a population size of approximately 37,856. The District's existing water system is divided into six pressure zones with three water storage reservoirs, 11 active interconnects, one emergency pump station, 33 active pressure reducing valves, and approximately 168 miles of water distribution mains. The District's existing water system facilities are discussed in detail in **Section 2**.

Water Supply and Demand

The District's potable water supply sources include local water supply from surface water captured in Lake Hodges and raw and treated water imported from San Diego County Water Authority (SDCWA). Both raw water sources are treated at the R.E. Badger Filtration Plant (REB Plant) which the District jointly owns with the Santa Fe Irrigation District (SFID). The District and SFID share rights to 5,700 Acre-Feet (AF) of the water entering Lake Hodges in any single year, which is 50% of the total hydraulic yield of 11,400 AFY. Any surface water runoff in excess of the total hydraulic yield is split between the District and SFID (50%) and the City of San Diego. The District receives water from the REB plant through 36-inch and 30-inch high pressure mains to Pressure Zone 520 and gravity feeds thereafter into all other pressure zones and storage reservoirs. In Fiscal Year (FY) 2020, local sources (Lake Hodges) provided approximately 45% of the District's supply while imported sources (SDCWA) provided the remaining 55%.

The District's historical water billing records and water supply data of the past ten fiscal years were reviewed and utilized to characterize the District's existing water supply and water demand. The District's water supply and water use has shown significant reduction post FY 2015, most likely due to increased water conservation measures and mandated water conservation restrictions. In FY 2020, the District had approximately 12,009 active service connections with approximately 4.8 million gallons per day (mgd) of billed water use. Approximately 77% of the water use was from residential customers. Nineteen (19) water users are identified as large water users that generated an ADD greater than 10,000 gpd in FY 2020. The District's water supply of FY 2020 was approximately 4.9 mgd. For hydraulic analysis in this Master Plan, the existing average daily demand (ADD) was estimated to be 4.9 mgd by averaging the water supply data of the past five fiscal years to account for non-revenue water usage.

The District has identified 11 known future developments within its service area with estimated development demands of 0.55 mgd. The future water demands projected in this Master Plan are based on the demand forecasts developed by SDCWA for the District for its 2020 Urban Water Management Plan (UWMP). The District's long-term future (2040) potable water demand is projected to be 5.7 mgd. The District's existing and future water supply and water demand is discussed in **Section 3**.

Hydraulic Model Update

The District's hydraulic model, developed as part of the 2010 Water Master Plan, was updated and refined as part of this Master Plan. A few major system improvements and changes to boundary conditions were implemented since the 2010 model was developed. The hydraulic model was updated based on the most recent GIS database, the updated demands, and information provided by operation staff, and verified with SCADA data to reflect the current conditions. Updates and refinements to the hydraulic model are discussed in **Section 5**.

Hydraulic Evaluation

The system is evaluated under various existing and future (2040) demand conditions using the updated hydraulic model. The planning criteria used for evaluating the system is discussed in **Section 4**. The hydraulic evaluation includes model analysis of the distribution system, desktop analysis of storage capacity, and desktop analysis of emergency interconnects under existing demand and future demand scenarios. The system was evaluated with existing demands and future (2040) demands under Average Day Demand (ADD), Maximum Day Demand (MDD), Peak Hour Demand (PHD), and Maximum Day Demand plus Fire Flow (MDD + FF) scenarios under

steady-state conditions (SS). The system was also evaluated with the existing demands and 2040 demands under 24-hour MDD extended period simulation (EPS) and 21-day Minimum Day Demand (MinDD) EPS.

For the existing system, model results indicate that one demand junction is not meeting the District's minimum allowable pressure criteria of 40 psi under PHD condition and 12 demand junctions exceed the maximum pressure criteria of 150 psi under ADD condition. All the junctions exceeding the maximum pressure criteria of 150 psi are located in Pressure Zone 520 due to lower elevation within the zone. The junction not meeting the minimum allowable pressure criteria is located near the Encinitas Ranch Reservoir.

Some areas in the District are within the Very High Fire Hazard Severity Zone (VHFHSZ) which have a fire flow requirement of 2,500 gpm. Fire flow requirements for Single-Family Residential parcels within VHFHSZ increase from 1,500 gpm to 2,500 gpm. Approximately 230 junctions are not meeting the District's pressure and velocity criteria under the existing MDD + FF condition. Seventy-three (73) of the junctions are unable to sustain the required fire flow at a minimum residual pressure of 20 psi.

Model results of the 24-hour MDD EPS scenario indicate that the Encinitas Ranch emergency pump station has sufficient capacity to supply the system under MDD conditions if the REB Plant is offline. Model results of the 21-day MinDD EPS scenario indicate that water age is approximately five and a half days old throughout most of the system with age ranging from 54 hours to 21 days in dead-end areas of the system. Zones 240, 345, 410, and 520 all contain at least one model demand node with high water age of 21 days under the MinDD EPS scenario.

For the 2040 system, model results indicate that five (5) demand junctions are not meeting the District's minimum allowable pressure criteria under PHD condition and twelve (12) demand junctions exceed the maximum pressure criteria under ADD conditions due to similar reasons identified for the existing system. Approximately 248 junctions are not meeting the District's pressure and velocity criteria under the 2040 MDD + FF condition. Seventy-six (76) junctions are unable to sustain the required fire flow at a minimum residual pressure of 20 psi.

Model results of the 24-hour MDD EPS scenario indicate that the Encinitas Ranch emergency pump station has sufficient capacity to supply the system under 2040 MDD condition if the REB Plant is offline. Model results of the 21-day MinDD EPS scenario indicate that water age is approximately four days old throughout most of the system with age ranging from 41 hours to 21 days in dead-end areas of the system under the 2040 MinDD condition. Zones 240, 345, and 520 all contain at least one model demand node with high water age of 21 days.

The desktop storage analysis indicates that the system has adequate storage in the Badger Clearwell, Encinitas Ranch Reservoir, and Balour Reservoir to meet the storage criteria without using the emergency pump station with existing and 2040 demands.

A desktop emergency interconnects analysis was performed on the District's emergency interconnects. Interconnection capacity was estimated based on the effective connection size from either side of the interconnect and flow velocity of 5 fps. The analysis indicates that the District can receive up to 21 mgd of flow from neighboring agencies via its 13 interconnects theoretically, more than three times of the District's projected 2040 ADD of 5.7 mgd. It is unlikely that the District would utilize all the interconnects at the same time during an emergency, and additional factors such as neighboring agencies' available supply and hydraulic limitations in neighboring agency distribution systems should also be considered.

Details of the hydraulic analyses are discussed in **Section 6**.

Asset Management Study

An asset management study was performed on the District's water mainlines, valves, and service mains using a data driven approach to evaluate the asset conditions and develop condition-based capital improvement program (CIP) to sustain desired levels of service. The asset management study utilizes the latest GIS database and historical maintenance data over the past 17 years. The District's break rate is approximately 0.8 annual breaks per 100 miles, which is within the top quartile of utilities in California in terms of break rate. The District's service break rate is estimated to be 2.0 annual breaks per year per 1,000 services owned, and is about three times better than the average in California. A pipeline renewal budget of \$700,000 dollars per year including soft costs but excluding inflation is estimated using performance-based approach. Three areas were identified as being high risk based on the system-wide risk assessment with District Staff. These areas represent less than 1% of the system by length but account for 48% of all documented condition related main breaks. Three near-term (5-Year) pipeline replacement projects are recommended in these areas. The total cost of these projects is estimated to be approximately \$3.42 million dollars.

In addition to the pipeline replacement projects, three additional condition-based projects are recommended, including opportunistic Asbestos cement (AC) pipe condition assessment, proactive large diameter (14-inch or larger in diameter) pipes condition assessment, and contingency for cathodic protection, valves replacement, and other appurtenance renewal. Details of the asset management study are discussed in **Section 7**.

Capital Improvement Program (CIP)

Deficiencies found from the hydraulic analysis, desktop analysis, and asset management study were addressed with recommended CIP projects. These CIP projects include pipe condition assessments, pipe replacement, pipe upsizing, and improvements for water quality enhancement, as shown in Table ES-1 and Table ES-2. These CIP projects are prioritized into short-term (5-Year, 2022-2027) CIP and long-term (10-Year, 2028-2032) CIP with estimated capital costs. Estimated capital costs of the 5-Year CIP are approximately \$10.3 million dollars and estimated capital costs of the 10-Year CIP are approximately \$5.6 million dollars, for a total of \$15.9 million dollars. Besides the CIP projects, there are a few improvements proposed to increase service resilience and reliability but are considered low priority and optional. Details of the CIP are discussed in **Section 8**.

Table ES-1. Proposed Capital Improvements

Priority	Type	Project #	Project Name	Note	Criteria Violated at Required Fire Flow	within VHFHSZ	Fire Flow (gpm)		Percent Available	Existing Diameter (in.)	Recommended Pipe Length per Diameter (feet)					Length (miles)	Phase	Additional Notes	
							Available	Required			8	10	12	16	18				Total
1	Condition-based	NT-1	Condition-based Project 1	Alley between Edinburg and Cambridge from Liverpool past Norfolk						6	1,409					1,409	0.3	2022-2027	See Section 7.3.2.1 for Detail
1	Condition-based	NT-2	Condition-based Project 2	1957 AC Pipe East of Glen Park						6 and 12	1,487		780			2,267	0.4	2022-2027	See Section 7.3.2.2 for Detail
1	Condition-based	NT-3	Condition-based Project 3	Arcadia						6 and 12	2,400		840			3,240	0.6	2022-2027	See Section 7.3.2.3 for Detail
1	Capacity-based	NT-4	Alley/Montgomery	Upsized existing pipe(s)	Negative Pressure	Yes	1,053	2,500	42%	4 and 6	1,273					1,273	0.2	2022-2027	upsized the 4-inch line in Alley between Norfolk Dr and Dublin Dr to 8-inch line; upsized the 6-inch line in Montgomery Ave southeast of Kelkenny Dr to 8-inch line
1	Capacity-based	NT-5	Andrew/Leucadia Scenic	Upsized existing pipe(s)	Negative Pressure	Yes	1,200	2,500	48%	8		978				978	0.2	2022-2027	upsized the 8-inch line in Andrew Ave and Leucadia Scenic Ct north of Deer Path to 10-inch line
1	Capacity-based	NT-6	Avocet Ct	Upsized existing pipe(s)	Negative Pressure	Yes	1,366	2,500	55%	6			308			308	< 0.1	2022-2027	upsized the 6-inch line segment in Avocet Ct between Wales Dr and the first hydrant to 12-inch line
1	Capacity-based	NT-7	Eolus Ave	Upsized existing pipe(s)	Negative Pressure	Yes	1,526	2,500	61%	2 and 6	664	1,069				1,733	0.3	2022-2027	upsized the 2-inch and 6-inch line in Eolus Ave between Hymettus Ave and Parkwood Ln to 8-inch line; upsized the 6-inch line in Eolus Ave between Parkwood Ln and Deer Path to 10-inch line
1	Capacity-based	NT-8	Noma Ln	Upsized existing pipe(s)	Negative Pressure	Yes	1,580	2,500	63%	8			278			278	< 0.1	2022-2027	upsized the 8-inch line in Noma Ln between Caudor St and Leora Ln to 12-inch line
1	Capacity-based	NT-9	Via Tiempo	Upsized existing pipe(s)	Negative Pressure	Yes	2,014	2,500	81%	8		1,173				1,173	0.2	2022-2027	upsized the 8-inch line in Via Tiempo between Wales Dr and Ruddy Duck Ct to 10-inch line
1	Capacity-based	NT-10	Edinburg Ave	Upsized existing pipe(s)	Pressure 1 psi	Yes	2,192	2,500	88%	6	601					601	0.1	2022-2027	upsized the 6-inch line in Edinburg Ave between Chesterfield Dr and Norfolk Dr to 8-inch line
1	Capacity-based	NT-11	Gascony Road	Upsized existing pipe(s)	Pressure 9 psi	Yes	2,075	2,500	83%	6 and 10				697	1,719	2,416	0.5	2022-2027	upsized ~1280 LF of 6-inch line and ~440 LF of the 10-inch line in Gascony Rd north of Capri Rd and south of 1687 Gascony Rd to 18-inch line; upsized the 10-inch line in Gascony Rd north of 1687 Gascony Rd and south of 1734 Gascony Rd to 16-inch line
2	Capacity-based	NT-12	Devonshire Drive	Upsized existing pipe(s)	Negative Pressure		1,786	3,500	51%	6	1,058	58	17			1,133	0.2	2022-2027	upsized the 6-inch line in Devonshire Dr. between the 12-inch line south of Requeza St and the 12-inch line in Melba Rd to 8-inch line; upsized the 6-inch line in Devonshire Dr. between the 6-inch line in Melba Rd and the 1st hydrant south Melba Rd to 10-inch line; upsized the 6-inch line segment in Melba Rd/Devonshire Dr between the 6-inch line and the 12-inch line to 12-inch line
2	Capacity-based	NT-13	2nd 3rd St Alley	Upsized existing pipe(s)	Negative Pressure		1,499	2,500	60%	6	981					981	0.2	2022-2027	upsized the 6-inch line in Alley between 2nd St and 3rd St between W E St and W H St to 8-inch line

Table ES-1. Proposed Capital Improvements

Priority	Type	Project #	Project Name	Note	Criteria Violated at Required Fire Flow	within VHFHSZ	Fire Flow (gpm)		Percent Available	Existing Diameter (in.)	Recommended Pipe Length per Diameter (feet)					Length (miles)	Phase	Additional Notes	
							Available	Required			8	10	12	16	18				Total
2	Capacity-based	NT-14	4th St	Upsized existing pipe(s)	Negative Pressure		1,854	3,000	62%	6	1,108					1,108	0.2	2022-2027	upsized the 6-inch line in 4th St between W E St and W G St to 8-inch line
2	Capacity-based	NT-15	I St & HWY 101	New looping pipe	Negative Pressure		1,615	2,500	65%	-	162					162	< 0.1	2022-2027	New 8-inch line north of W I St connecting the 12-inch line in S Coast Hwy 101 and the 6-inch line in Alley east of 2nd St
2	Capacity-based	NT-16	Regal Road	Upsized existing pipe(s)	Negative Pressure		1,630	2,500	65%	6	1,468	385	985			2,838	0.5	2022-2027	upsized the 6-inch line in Melba Rd between the Regal Rd and the 8-inch line near 528 Melba Rd to 12-inch line; upsized the 6-inch line in Regal Rd between Melba Rd and Park Ln to 12-inch line; upsized the 6-inch line in Regal Rd between Park Ln and the Private Rd to the North to 10-inch line; upsized the 6-inch line in the Private Rd west of Park Ln and north of Park Ln to 8-inch line
2	Capacity-based	NT-17	HWY 101, 2nd Alley	Upsized existing pipe(s)	Pressure 13 psi		1,597	2,500	64%	6	1,003					1,003	0.2	2022-2027	upsized the 6-inch line in Alley east of 2nd St between E E St and W G St to 8-inch line
2	Capacity-based	NT-18	Union Street	Upsized existing pipe(s)	Pressure 19 psi		2,165	3,000	72%	6	628					628	0.1	2022-2027	upsized the 6-inch line in Union Street between Vulcan St and Hermes Ave to 8-inch line
2	Capacity-based	NT-19	Mozart Ave	Upsized existing pipe(s)	Pressure 15 psi, Velocity 19 fps		2,415	3,000	81%	6	263					263	< 0.1	2022-2027	upsized the 6-inch line in Mozart Ave between Montgomery Ave and the 8-inch line to the south to 8-inch line
3	Condition-based	NT-20	Condition-based Project 4-1	Opportunistic AC Condition Assessment											0	< 0.1	2022-2027	Refer to Section 7.3.3 of Master Plan.	
4	Capacity-based	LT-1	La Veta Ave	Upsized existing pipe(s)	Velocity 21 fps		1,821	2,500	73%	6	392					392	< 0.1	2028-2032	upsized the 6-inch line in La Veta Ave between Marcheta St and the 2nd hydrant to 8-inch line
4	Capacity-based	LT-2	W J Street	Upsized existing pipe(s)	Velocity 20 fps		1,868	2,500	75%	6	129					129	< 0.1	2028-2032	upsized the 6-inch line north of W J St between 3rd St and Alley to 8-inch line
4	Capacity-based	LT-3	Soho Road	Upsized existing pipe(s)	Velocity 20 fps		1,919	2,500	77%	6	144					144	< 0.1	2028-2032	upsized the 6-inch line in Soho Rd between Piccadilly Rd and Kennington Rd to 8-inch line
4	Capacity-based	LT-4	Stater Brothers	Upsized existing pipe(s)	Velocity 20 psi		2,719	3,500	78%	8		250				250	< 0.1	2028-2032	upsized the 8-inch line in Town Central Pl in front of Stater Bros between the two hydrants south of Leucadia Blvd to 10-inch line
4	Capacity-based	LT-5	C St	Upsized existing pipe(s)	Velocity 19 fps		1,991	2,500	80%	6	109					109	< 0.1	2028-2032	upsized the 6-inch line in C St between 3rd St and the 1st hydrant to the east to 8-inch line
5	Water Quality	LT-6	Automatic Flusher	Automatic Flusher to Mitigate Water Quality Issues in 240 Zone	Water Quality					-					0	< 0.1	2028-2032	Automatic flusher near Via Poco and Manchester Ave to mitigate water age issues in 240 Zone	
5	Water Quality	LT-7	Santa Fe Dr	New Pipe & PRV Connecting 520 and 240 Zones	Water Quality					-			1,011		1,011	0.2	2028-2032	new PRS and new 12-inch line in Santa Fe Dr connecting the 12-inch line upstream of existing PRV near Santa Fe Dr and Nardo Rd from 520 Zone to 240 Zone. This project is to be after the successful implementation of LT-6.	

Table ES-1. Proposed Capital Improvements

Priority	Type	Project #	Project Name	Note	Criteria Violated at Required Fire Flow	within VHFHSZ	Fire Flow (gpm)		Percent Available	Existing Diameter (in.)	Recommended Pipe Length per Diameter (feet)					Length (miles)	Phase	Additional Notes
							Available	Required			8	10	12	16	18			
5	Condition-based	LT-8	Condition-based Project 4-2	Opportunistic AC Condition Assessment											0	< 0.1	2028-2032	Refer to Section 7.3.3 of Master Plan.
5	Capacity-based	LT-9	Burgundy Ave	Upsized existing pipe(s)	Pressure 13 psi		2,320	2,500	93%	8		1,629			1,629	0.3	2028-2032	upsized the 8-inch line in Burgundy Ave north of Capri Rd to 10-inch line to help improve fire flows in the VHFHSZ
5	Capacity-based	LT-10	Kennington Road	Upsized existing pipe(s)	Pressure 12 psi		2,328	2,500	93%	6	390				390	< 0.1	2028-2032	upsized the 6-inch line in Kennington Rd between Soho Rd and the 1st hydrant north of Bishopgate Rd to 8-inch line
5	Capacity-based	LT-11	Cornish Dr & HWY 101	New looping pipe	Pressure 10 psi, Velocity 16 fps		2,362	2,500	94%	-		144			144	< 0.1	2028-2032	Construct new 10-inch line west of Cornish Dr connecting the 6-inch in San Elijo Ave and the 8-inch line in Coast Hwy 101
6	Condition-based	LT-12	Condition-based Project 5	CP, Appurtenance, & Contingency													2028-2032	Refer to Section 7.3.5 of Master Plan.
											Total	27,989	5.3					

Table ES-2. Summary Capital Improvement Cost Estimates

Priority	Project #	Type	Project Name	Estimated Capital Costs (\$)	Phase
1	NT-1	Condition-based	Condition-based Project 1	599,000	2022-2027
1	NT-2	Condition-based	Condition-based Project 2	963,000	2022-2027
1	NT-3	Condition-based	Condition-based Project 3	1,377,000	2022-2027
1	NT-4	Capacity-based	Alley/Montgomery	541,000	2022-2027
1	NT-5	Capacity-based	Andrew/Leucadia Scenic	416,000	2022-2027
1	NT-6	Capacity-based	Avocet Ct	131,000	2022-2027
1	NT-7	Capacity-based	Eolus Ave	736,000	2022-2027
1	NT-8	Capacity-based	Noma Ln	118,000	2022-2027
1	NT-9	Capacity-based	Via Tiempo	498,000	2022-2027
1	NT-10	Capacity-based	Edinburg Ave	256,000	2022-2027
1	NT-11	Capacity-based	Gascony Road	1,027,000	2022-2027
2	NT-12	Capacity-based	Devonshire Drive	482,000	2022-2027
2	NT-13	Capacity-based	2nd 3rd St Alley	417,000	2022-2027
2	NT-14	Capacity-based	4th St	471,000	2022-2027
2	NT-15	Capacity-based	I St & HWY 101	69,000	2022-2027
2	NT-16	Capacity-based	Regal Road	1,206,000	2022-2027
2	NT-17	Capacity-based	HWY 101, 2nd Alley	426,000	2022-2027
2	NT-18	Capacity-based	Union Street	267,000	2022-2027
2	NT-19	Capacity-based	Mozart Ave	112,000	2022-2027
3	NT-20	Condition-based	Opportunistic AC Condition Assessment	225,000	2022-2027
5-Yr CIP Total (\$)				10,337,000	
4	LT-1	Capacity-based	La Veta Ave	167,000	2028-2032
4	LT-2	Capacity-based	W J Street	55,000	2028-2032
4	LT-3	Capacity-based	Soho Road	61,000	2028-2032
4	LT-4	Capacity-based	Stater Brothers	106,000	2028-2032
4	LT-5	Capacity-based	C St	47,000	2028-2032
5	LT-6	Water Quality	Automatic Flusher	200,000	2028-2032
5	LT-7	Water Quality	Santa Fe Dr	680,000	2028-2032
5	LT-8	Condition-based	Opportunistic AC Condition Assessment	225,000	2028-2032
5	LT-9	Capacity-based	Burgundy Ave	692,000	2028-2032
5	LT-10	Capacity-based	Kennington Road	166,000	2028-2032
5	LT-11	Capacity-based	Cornish Dr & HWY 101	61,000	2028-2032
6	LT-12	Condition-based	CP, Appurtenance, & Contingency	3,130,000	2028-2032
10-Yr CIP Total (\$)				5,590,000	
Total (\$)				15,927,000	

* Costs are rounded to the nearest thousands.

1. Introduction

This section provides an overview of the project background, purpose, and scope of work of this Master Plan for the District.

1.1. Background and Purpose

The District's last **Potable Water System Master Plan (2010 WMP)** was prepared in June 2010 by Infrastructure Engineering Corporation (IEC). Many of the capital improvements recommended in that plan have been constructed, and operational changes were made to the system since then. In May of 2020, the District contracted with Infrastructure Engineering Corporation (IEC) to develop a new Water Master Plan (Master Plan) alongside a Water Capacity Fee Study. The intent of this Master Plan is to update the **2010 WMP** including update of water demand projections, update and refinement of the existing water distribution model, and recommendations of a 10-year Capital Improvement Program (CIP) based on the hydraulic evaluation and asset management study. The results of the recommended improvements are used to develop the District's Water Capacity Fee Study. These documents will create a roadmap for the District by evaluating its potable water distribution system's ability to effectively meet existing and future system demands as well as develop a rate structure to pay for recommended capital improvements. IEC sub-contracted with HDR Inc, Bartle Wells, and Mark Henderson Appraisals that collectively form the Project Team.

1.2. Scope of Work

This Master Plan includes the following tasks:

- Summarize the District's existing water system facilities
- Evaluate the current and future state of water supply and demand
- Review and update the District's hydraulic planning criteria
- Refine the existing model through calibration and verification with field data
- Perform hydraulic evaluation of the water system under existing and future conditions and identify hydraulic and capacity-related deficiencies
- Perform an asset management study and develop condition-based improvements
- Make recommendations and cost estimates on system improvements

1.3. Data Sources

This Master Plan is developed using various data and information, including but not limited to the following:

- 2010 Water System Master Plan (2010 WMP)
- 2020 Urban Water Management Plan (2020 UWMP)
- Customer billing records and water supply data
- Latest water system geodatabase and land use geodatabase
- Operational Records and Settings include but not limited to fire flow tests, SCADA data, pump station data, and Pressure Reducing Station (PRS) data
- Facilities as-builts and plans
- 2012 Joint Facilities Master Plan

In addition, the Project Team worked collaboratively with District staff and utilized their knowledge to understand the provided data, system operational issues, and other general information on the system.

2. Existing Water System

This section provides general information on the District's service area and summarizes the existing water system facilities.

2.1. Service Area Description

When the City of Encinitas (City) was incorporated in 1986, the District became a subsidiary district of the City. The five City Council members (elected Mayor and four elected Council Members) also serve as the Board of Directors of the District. The District's services area spans north to south with approximately nine square miles of the western half of the City covering the communities of Leucadia, Old Encinitas, Cardiff, and portions of New Encinitas as shown in **Figure 2-1**. The remainder of the City is served by the Olivenhain Municipal Water District (OMWD). The District serves a population size of approximately 37,856 that consists of residential and commercial customers. The District is more than 90 percent built-out; therefore, projected future growth is expected to be low.

2.1.1. Terrain and Climate

The terrain of the District consists of rolling hills and valleys with elevations ranging from sea level to approximately 400 feet above sea level. The climate is semi-arid with an average annual precipitation of 10.34¹ inches. Rainfall occurs mostly in the cooler half of the year, between December and March, while the summer months are virtually rainless with no measurable precipitation typically occurring. Compared to national averages², the rest of the country experiences more than 100 days of precipitation, while San Diego only experiences 43 days. The national average for sunny days³ is approximately 103, while San Diego experiences 146.

The borderline arid climate combined with the relative lack of rainfall compared to the rest of the country presents challenges to water supply planning, both short term and long term. The fact that the region experiences most of its rainfall within a short amount of time also presents challenges to agencies in Southern California, such as the District. The District typically experiences two very distinct water consumption patterns, one for the wet season and one for the dry season, when landscape irrigation needs increase dramatically.

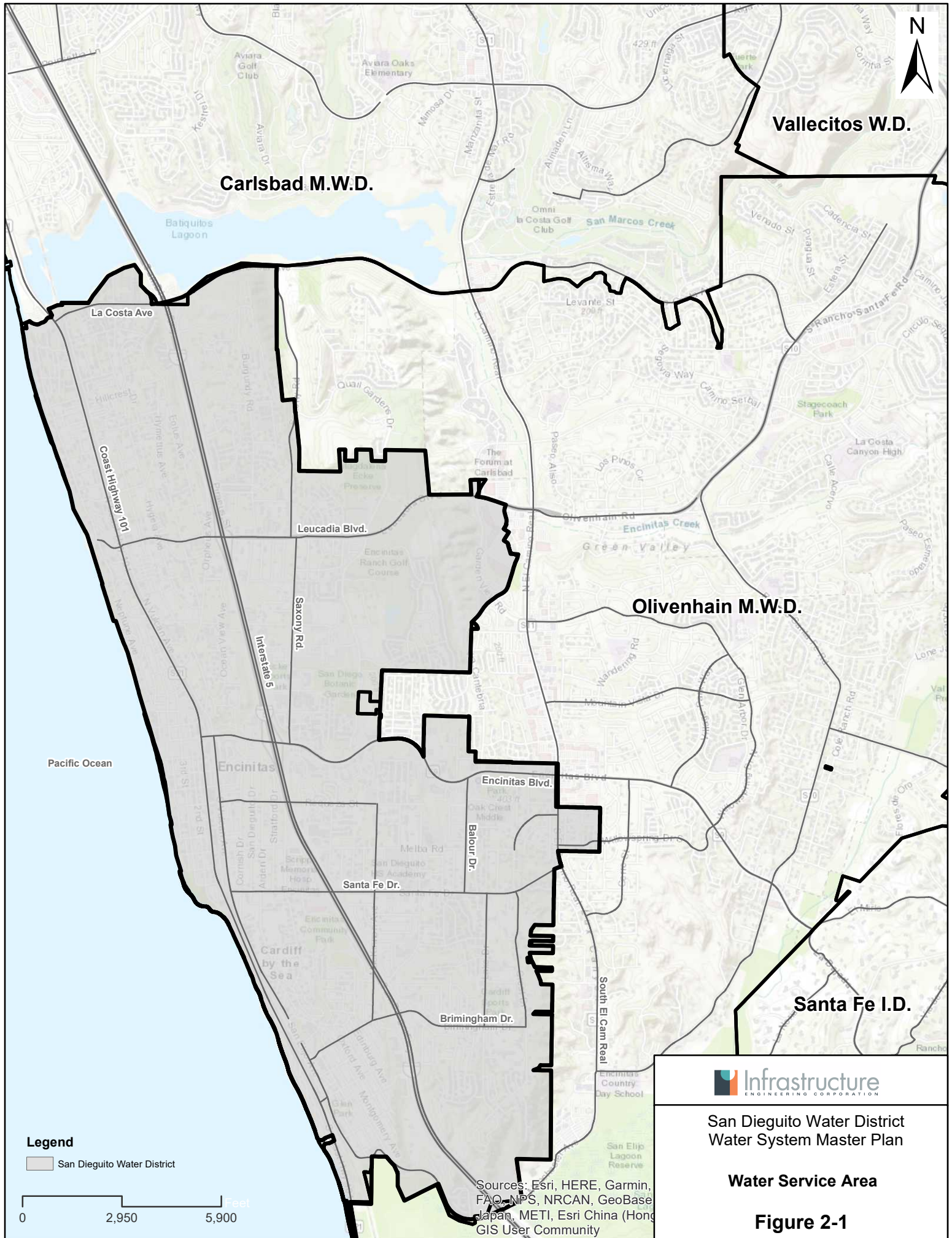
2.2. Water Distribution System

The District's potable water distribution system consists of six pressure zones with three water storage reservoirs, 13 active interconnects, one emergency pump station, 33 active pressure reducing valves, and approximately 168 miles of water mains, as shown in Figure 2-2. Figure 2-3 shows a schematic of the District's potable water system. Water flows from the REB plant through 36-inch and 30-inch high pressure mains to Pressure Zone 520 and gravity feeds thereafter into all other pressure zones and storage tanks. A pump station at Encinitas Ranch Reservoir is used to pump water back up to Pressure Zone 520 during emergencies only.

¹ Source: 2020 Climate Data from U.S. Climate Data (<https://www.usclimatedata.com/climate/san-diego/california/united-states/usca0982>)

² <https://www.currentresults.com/Weather/US/weather-averages-index.php>

³ The average number of sunny days is the total days in a year when the sky is mostly clear. This includes the days when cloud cover is up to 30% of the sky during daylight hours



Vallecitos W.D.

Carlsbad M.W.D.

Olivenhain M.W.D.

Santa Fe I.D.

Legend
 San Diego Water District

0 2,950 5,900 Feet

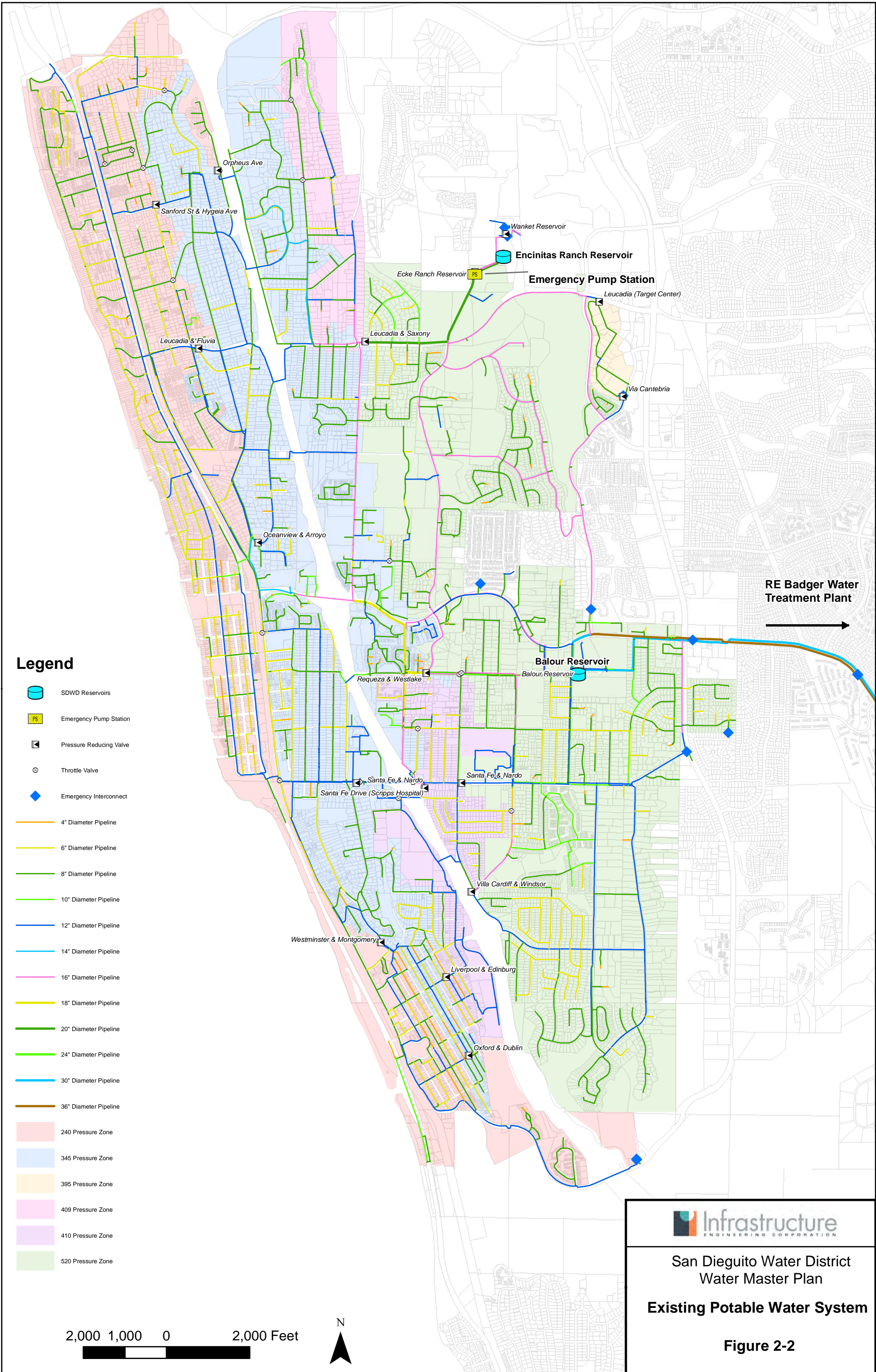
Infrastructure
 ENGINEERING CORPORATION

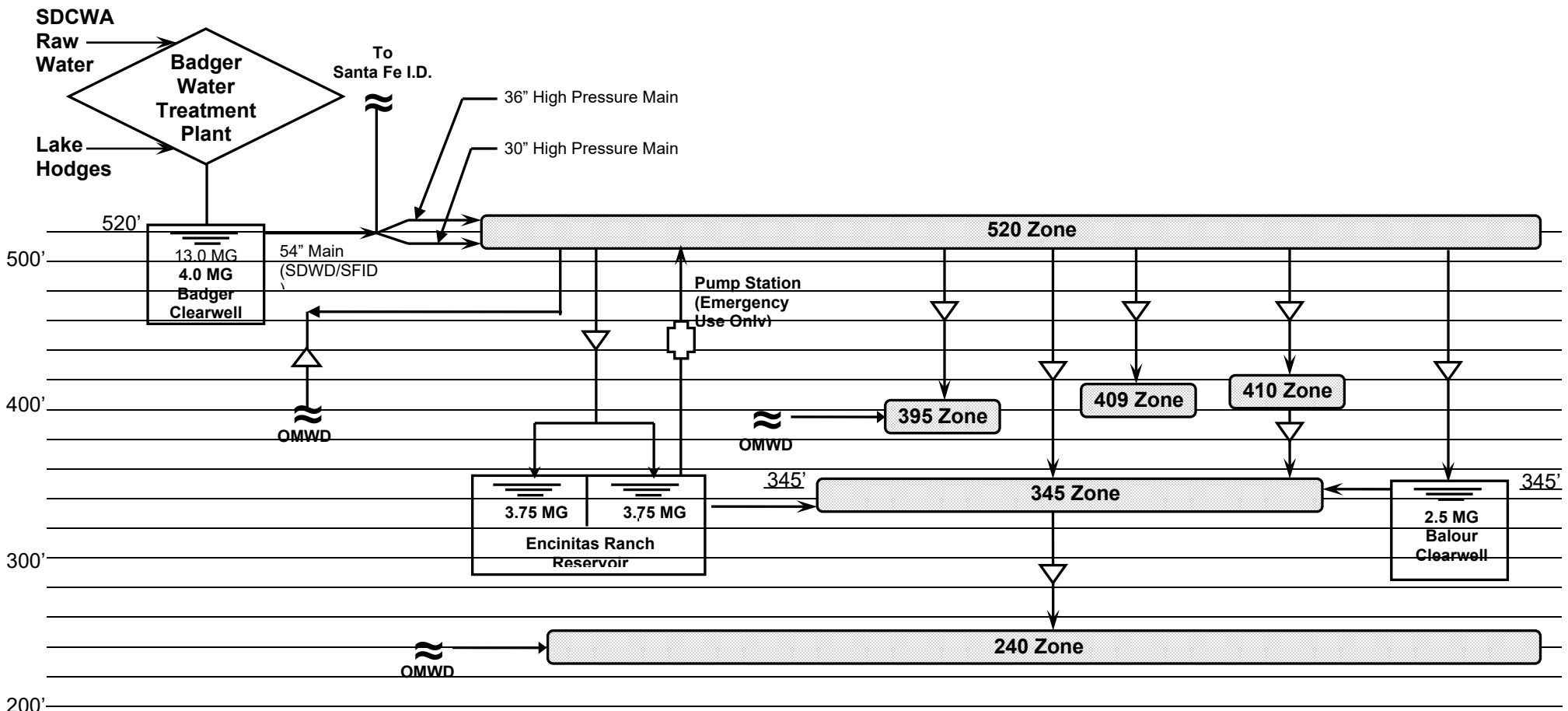
San Dieguito Water District
 Water System Master Plan

Water Service Area

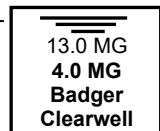



Figure 2-1


Sources: Esri, HERE, Garmin, FAO, NPS, NRCAN, GeoBase, Japan, METI, Esri China (Hong Kong), Swisstopo, Mapbox, OpenStreetMap contributors, and the GIS User Community





Legend

- 
 Reservoir with:
 Maximum Water Surface Elevation
 Total Facility Capacity
 SDWD Ownership Capacity
- 
 Pressure Zone
- 
 Pressure Reducing Stations (PRS)
- 
 Interconnection



San Dieguito Water District
Water System Master Plan

SDWD Water System Schematic

Figure 2-3

2.2.1. Tanks

The District operates three (3) potable water reservoirs to serve its community. The District has full ownership of Balour and the Encinitas Ranch Reservoirs and shares ownership of the REB Plant Clearwell. The District also shares ownership of the Wanket Tank with Olivenhain Municipal Water District (OMWD) which is currently out of service. Hydraulic information input into the model for each of these reservoirs is summarized in Table 2-1.

Table 2-1. Existing Reservoir Information

Tank	Total Capacity (MG)	District Capacity (MG)	Base Elevation (ft)	High Water Level (ft)	Height (ft)
Encinitas Ranch	7.5	7.5	325	17	20
Balour Reservoir	2.5	2.5	325	16	20
Badger Clearwell	13.0	4.0	495	-	25
Wanket Tank*	3.0	1.0	398	-	30

* Not currently in use

2.2.2. Interconnects

The District has thirteen (13) potable water interties/interconnects with OMWD and SFID as listed in Table 2-2. These interconnects are typically closed and only utilized to enhance supply reliability under emergency conditions. Details for each interconnect and its available flow rate is discussed in Section 6.3.

Table 2-2. Emergency Interconnects

Name	Location Description	Year Installed	Pressure Zone	Connecting Agency
WANKET TANK (S/E Connection)	southern valve connected to Wanket Tank	1981	520	OMWD
WILLOWSPRINGS	on Encinitas Blvd., between Village Park Way and Willowspring Drive	1982	520	OMWD
COLE RANCH RD	intersection of El Camino Del Norte and Cole Ranch Road	N/A	520	OMWD
1439 ENCINITAS BLVD	on Encinitas Blvd, east of El Camino Real (near VW cars)	1967	520	OMWD
DELPHINIUM	on Delphinium Street (north of Encinitas Blvd near Teaberry Street)	1978	520	OMWD
VIA POCO	Via POCO/Manchester	2012	240	OMWD
OAKBRANCH	337 Oakbranch Drive	1982	520	OMWD
S ECR at Santa Fe Dr	S. El Camino Real at Santa Fe Drive intersection	1982	520	OMWD

Name	Location Description	Year Installed	Pressure Zone	Connecting Agency
VIA CANTEBRIA DR @ VIA TERRA	on Via Cantebria north of Encinitas Blvd	1995	520	OMWD
EL MIRLO & VIA DE FORTUNA	Via de Fortuna and El Miro	N/A	520	SFID
EL CAMINO DEL NORTE WEST OF LOMA ALGRE	El Camino Del Norte west of Loma Alegre	1982	520	SFID
VIA CANTEBRIA NORTH GARDEN VIEW	Encinitas Town Center (Target Center)	1995	520	OMWD
VIA CANTEBRIA @ PACIFICA	Via Cantebria at Pacifica Place	N/A	520	OMWD

2.2.3. Pipes

The District owns or maintains 168 miles of pipe. A summary of the pipeline lengths by material and diameter obtained from the District's GIS Database is provided in Table 2-3.

Table 2-3. District Pipe Inventory

Diameter (in)	Asbestos Cement	Concrete Cylinder	Cement Coated Steel	Cement	Cement-Mortar Lined	Copper	Ductile Iron	Galvanized Iron	High Pressure	PLSC	Polyvinyl Chloride	Steel	Unknown	Total (ft)	Total (miles)	Percent Length
2.5													237	237	< 1	< 1 %
3	636									570				1,206	< 1	< 1 %
4	11,921		12								6,358		383	18,674	4	2%
6	189,089										1,127		445	190,660	36	21%
8	188,880		303				105				110,435		1,595	301,319	57	34%
10	29,397										582		334	30,313	6	3%
12	130,931	1,485	957	282			24				42,222		1,772	177,674	34	20%
14	8,990		1,100											10,090	2	1%
16	31,658		29								36,516	96	1,813	70,111	13	8%
18	34		3,054										15	3,103	1	< 1 %
20					381						4,476		87	4,944	1	1%
24			3,491									52	15	3,558	1	< 1 %
30	1,200		24,254						2,148			89		27,691	5	3%
36			24,904						2,529					27,433	5	3%
54												10,404	9,381	19,785	4	2%
Total (ft)	592,736	1,485	58,105	282	381	-	129	-	4,676	570	201,715	10,642	16,078	886,798		
Total (miles)	112	< 1	11	< 1	< 1	< 1	< 1	< 1	1	0	38	2	3	168		
Percent Length	67%	0%	7%	< 1 %	< 1 %	< 1 %	< 1 %	< 1 %	1%	< 1 %	23%	1%	2%	100%		

2.2.4. Pump Station

The District’s water distribution system is equipped with one (1) emergency pump station. This pump station only operates under two (2) emergency conditions: loss of supply to the 520 Zone or in the event of a large fire in the vicinity of the Encinitas Ranch Reservoir. The pump station can also be used to improve water quality by circulating water in the reservoir. Hydraulic information input into the model for the pump station is summarized in Table 2-4.

Table 2-4. Existing Pump Station Information

Pump	Diameter (in)	Design Flow Rate (gpm)	Design Total Dynamic Head (ft)	Ground Elevation (ft)
Encinitas Ranch PS No. 1*	8	1,600	142	324
Encinitas Ranch PS No. 2*	8	1,600	142	324
Encinitas Ranch PS No. 3*	8	1,600	142	324

* Emergency Use Only

2.2.5. Pressure Reducing Valves

There are thirty-three (33) pressure reducing valves (PRV) currently operated by the District. A breakdown of pressure reducing valves per zone is shown in Table 2-5.

2.2.6. Recycled Water

The District purchases recycled water from the San Elijo Joint Powers Authority (SEJPA). The District also owns Oak Crest Tank that is leased/operated by SEJPA. Recycled water is primarily used to serve the Encinitas Ranch Golf Course, landscaped traffic medians, homeowner association (HOA) common areas, and a number of parks within the District.

2.2.7. SCADA

The District’s SCADA system is managed by an outside vendor, Freedom Automation, Inc. The system presently does not have a data historian and data is stored on SQL server. Operations staff have remote access capabilities to the SCADA system and currently use it for minor reporting functions.

Table 2-5. Pressure Reducing Valve Information

IEC ID	Location	Address	# of Valves	Sizes of Valves (in.)	Zone to Zone	Model Setting*
XV8035	Santa Fe & A-Tank	601 Santa Fe Dr.	2	8	345-240	13
XV8036				4		16
XV8031	Leucadia Blvd & Saxony Rd.	895 Saxony Rd.	4	8	520-409	84
XV8005				6		84
XV8006				4		20
XV8032				3		84
XV8012	Leucadia Blvd & Fulvia	835 Fulvia St.	3	8	345-240	60
XV8011				4		15
XV8033				3		53
XV8017	Liverpool & Edinburg	2088 Liverpool Dr.	2	8	410-345	63
XV8018				3		61
XV8013	Oceanview & Arroyo	310 Arroyo Dr.	2	6	345-240	46
XV8014				4		49
XV8020	Oxford & Dublin	2382 Oxford Ave.	2	8	345-240	40
XV8019				3		37
XV8009	Sanford St. & Hygeia Ave	302 Sanford St.	2	8	345-240	65
XV8010				3		62
37930WPRSTA	Santa Fe Dr. & Devonshire Ave	345 Santa Fe Dr.	1	10	240-240	Vented
XV8026	Santa Fe Dr. & Nardo Rd.	711 Santa Fe Dr.	2	8	520-410	73
XV8025				4		78
XV8015	Westminster Ave. & Montgomery Ave.	1881 Westminster Ave.	2	8	345-240	67
XV8016				3		62
XV8024	Westlake & Requeza	605 Requeza St.	2	8	520-345	50
XV8023				4		55
XV8008	Orpheus Ave. 1400 Blk.	1472 Orpheus Ave.	2	6	345-240	56
XV8007				2		61

IEC ID	Location	Address	# of Valves	Sizes of Valves (in.)	Zone to Zone	Model Setting*
XV8003	Via Cantabria-South (Target Center)	1010 N. El Camino Real	3	8	520-395	93
XV8004				6		15
XV8037				3		93
XV8002	Leucadia Blvd-North (Target Center)	1050 N. El Camino Real	2	8	520-395	92
XV8001				3		92
XV8022	Villa Cardiff Dr.	1583 Villa Cardiff Dr.	3	8	520-410	96
XV8021				4		15
XV8034				3		96

* Max Day Steady State (MDD_SS) Scenario

3. Water Supply and Demand

This section evaluates the District's historical water billing records and supply data to characterize the District's existing water demands. Historical water demand and supply are presented by fiscal year (FY) from July to June. For example, Fiscal Year 2011 is from July 1st, 2010 to June 30th, 2011. The average daily demand (ADD) for each water service account was linked to the District's water service connection geodatabase that was used for demand allocation in the hydraulic model.

Future water demands were developed based on the demands forecasted for the District's 2020 UWMP (prepared concurrently by Woodard and Curran) and future land use data provided by District staff.

3.1. Historical Water Use

Historical water billing records from FY 2011 to FY 2020 are utilized to evaluate the District's billed water use for the past ten years. The District's water use is billed bi-monthly and is categorized into 14 user types: Agriculture, Commercial, Government, Landscaping Government, Landscaping Public, Landscaping Residential, Landscaping Commercial, Multi-family with Agriculture, Multi-family with Commercial, Multi-family Residential, Public, Single Family with Agriculture, Single Family with Commercial, and Single Family Residential. Residential water use (including Single Family Residential and Multi-family Residential) accounts for approximately 76% of the total billed water use. Residential related water use (including Landscaping Residential, Multi-family with Agriculture, Multi-family with Commercial, Multi-family Residential, Single Family with Agriculture, Single Family with Commercial, and Single Family Residential) accounts for approximately 81% of the District's total billed water use. Figure 3-1 presents the historical water use by user type for the past ten years.

There are approximately 12,009 service connections by FY 2020 with meter sizes ranging from 5/8-inch to 8-inch. Table 3-1 summarizes the District's billed water use by user type. Table 3-2 summarizes the District's billed water use by meter size.

Water use for each service connection is linked to the District's meter geodatabase by matching the serial number from the billing records to the meter number in the meter geodatabase. Approximately 97.8% of the billing records are matched.

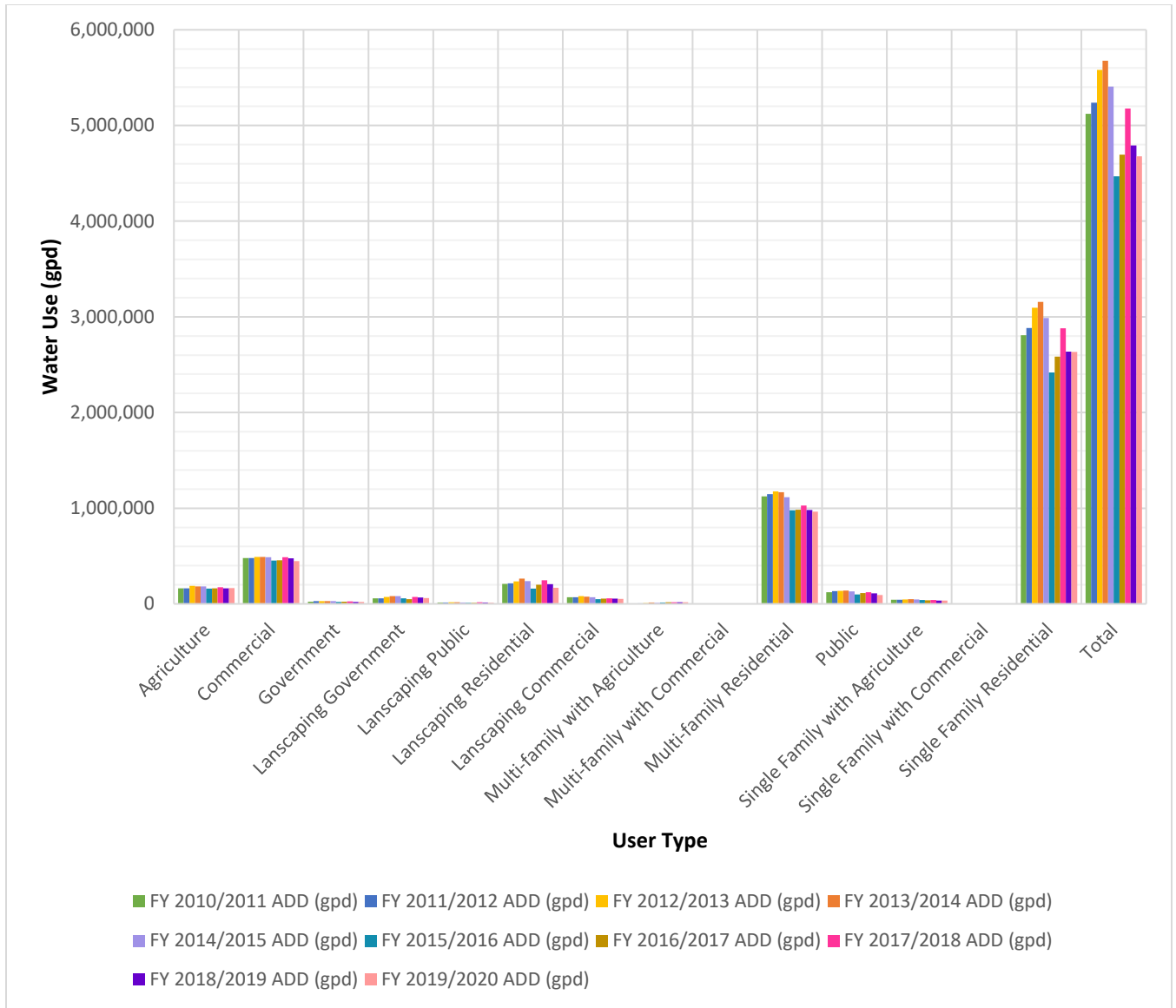


Figure 3-1. Historical Authorized Water Use

Table 3-1. Billed Water Use by User Type

User Type	FY 2015/2016			FY 2016/2017			FY 2017/2018			FY 2018/2019			FY 2019/2020		
	Number of Service Connection	ADD (mgd)	% to Overall Demand	Number of Service Connection	ADD (mgd)	% to Overall Demand	Number of Service Connection	ADD (mgd)	% to Overall Demand	Number of Service Connection	ADD (mgd)	% to Overall Demand	Number of Service Connection	ADD (mgd)	% to Overall Demand
Agriculture	65	0.160	3.6%	63	0.162	3.5%	63	0.175	3.4%	65	0.164	3.4%	63	0.166	3.6%
Commercial	522	0.452	10.1%	525	0.455	9.7%	527	0.487	9.4%	528	0.476	9.9%	530	0.448	9.6%
Government	19	0.021	0.5%	19	0.023	0.5%	19	0.026	0.5%	19	0.021	0.4%	19	0.019	0.4%
Landscaping Government	47	0.059	1.3%	47	0.048	1.0%	48	0.072	1.4%	49	0.066	1.4%	49	0.061	1.3%
Landscaping Public	7	0.013	0.3%	7	0.012	0.3%	7	0.017	0.3%	7	0.015	0.3%	7	0.013	0.3%
Landscaping Residential	129	0.161	3.6%	131	0.200	4.3%	132	0.248	4.8%	134	0.207	4.3%	136	0.168	3.6%
Landscaping Commercial	50	0.049	1.1%	50	0.056	1.2%	50	0.060	1.1%	50	0.054	1.1%	51	0.053	1.1%
Multi-family with Agriculture	5	0.015	0.3%	5	0.016	0.3%	4	0.018	0.4%	4	0.016	0.3%	4	0.017	0.4%
Multi-family with Commercial	3	0.002	0.0%	3	0.002	0.0%	6	0.003	0.0%	6	0.002	0.0%	6	0.002	0.1%
Multi-family Residential	1,709	0.978	21.9%	1,708	0.984	21.0%	1,713	1.029	19.9%	1,707	0.983	20.5%	1,712	0.964	20.6%
Public	97	0.098	2.2%	96	0.113	2.4%	97	0.121	2.3%	97	0.110	2.3%	102	0.094	2.0%
Single Family with Agriculture	26	0.041	0.9%	26	0.038	0.8%	26	0.042	0.8%	26	0.036	0.8%	26	0.035	0.8%
Single Family with Commercial	8	0.002	0.0%	8	0.002	0.0%	8	0.002	0.0%	9	0.002	0.1%	9	0.002	0.1%
Single Family Residential	9,019	2.420	54.1%	9,063	2.583	55.0%	9,149	2.879	55.6%	9,193	2.638	55.1%	9,295	2.635	56.3%
Total	11,706	4.470	100%	11,751	4.695	100%	11,849	5.178	100%	11,894	4.790	100%	12,009	4.679	100%

Table 3-2 Billed Water Use by Meter Size

Meter Size	FY 2015/2016			FY 2016/2017			FY 2017/2018			FY 2018/2019			FY 2019/2020		
	Number of Service Connection	ADD (mgd)	% to Overall Demand	Number of Service Connection	ADD (mgd)	% to Overall Demand	Number of Service Connection	ADD (mgd)	% to Overall Demand	Number of Service Connection	ADD (mgd)	% to Overall Demand	Number of Service Connection	ADD (mgd)	% to Overall Demand
5/8 inch	3741	0.978	21.9%	3740	1.024	21.8%	3748	1.102	21.3%	3717	1.023	21.4%	3704	1.007	21.5%
3/4 inch	5624	1.510	33.8%	5663	1.616	34.4%	5731	1.797	34.7%	5789	1.655	34.6%	5904	1.674	35.8%
1 inch	1467	0.573	12.8%	1471	0.589	12.5%	1490	0.656	12.7%	1508	0.614	12.8%	1520	0.606	12.9%
1-1/2 inch	435	0.405	9.1%	437	0.425	9.1%	437	0.478	9.2%	437	0.445	9.3%	434	0.415	8.9%
2 inches	434	0.955	21.4%	435	0.988	21.0%	438	1.089	21.0%	438	1.001	20.9%	442	0.935	20.0%
3 inch	2	0.008	0.2%	2	0.015	0.3%	2	0.015	0.3%	2	0.018	0.4%	2	0.017	0.4%
4 inch	2	0.002	0.0%	2	0.002	0.0%	2	0.003	0.0%	2	0.001	0.0%	2	0.002	0.1%
8 inch	1	0.039	0.9%	1	0.036	0.8%	1	0.039	0.8%	1	0.033	0.7%	1	0.023	0.5%
Total	11,706	4.470	100%	11,751	4.695	100%	11,849	5.178	100%	11,894	4.790	100%	12,009	4.678	100%

3.2. Large Water Users

About 99% of the District's meters are assigned to a parcel in the meter geodatabase, and approximately 92.6% of the District's billed water use in FY 2020 is assigned with a parcel. Based on the water use by parcel, the large water users are identified as those parcels generating an ADD greater than 10,000 gpd. Approximately 19 large water users are identified as presented in Table 3-3, and shown in Figure 3-2.

Table 3-3. Large Water Users in FY 2020

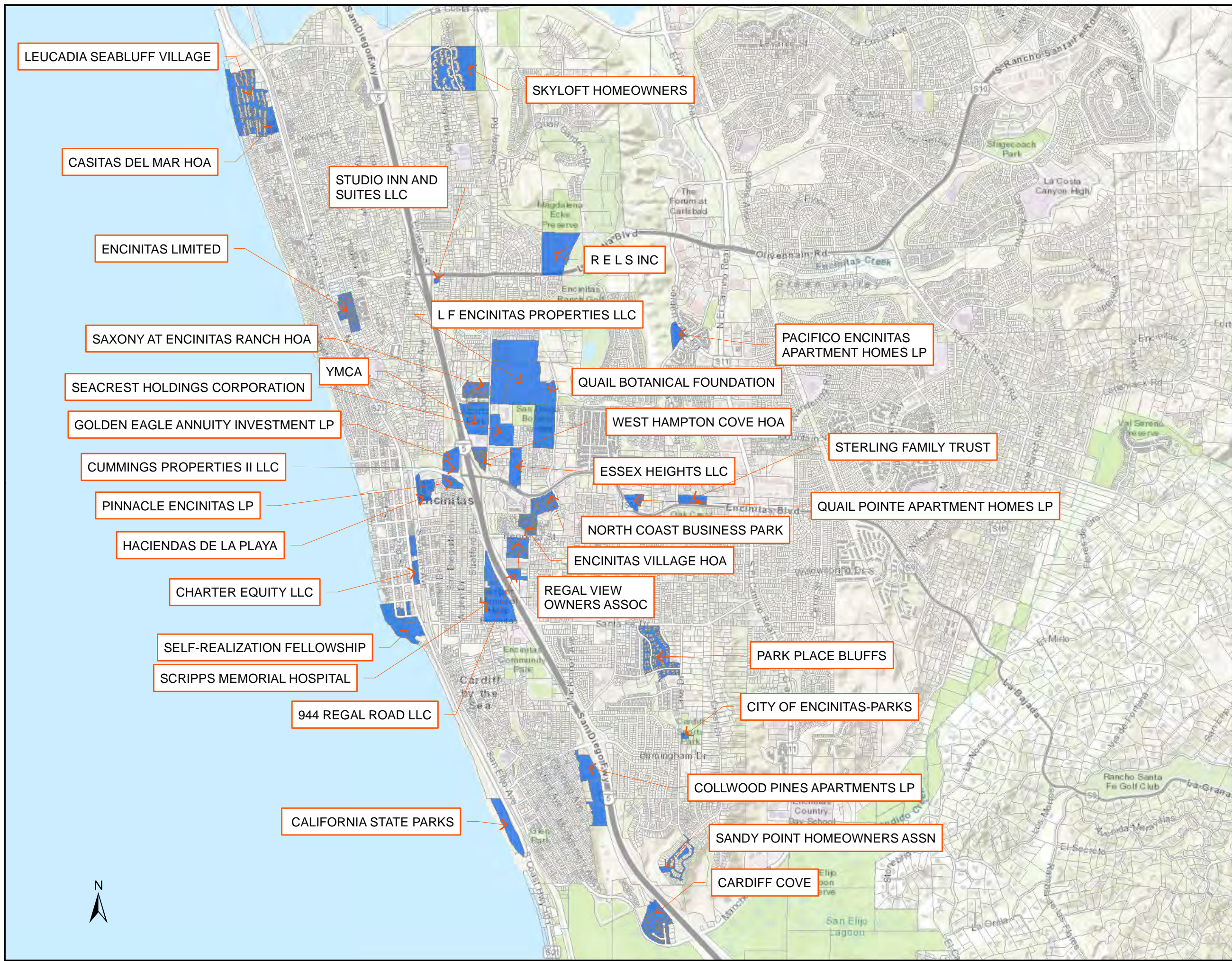
No	User	APN	Address	Account Type	FY 2020 Average Daily Demand (gpd)
1	L F Encinitas Properties LLC	2563306300/ 2563306200/ ...	SAXONY RD/ 810 Ecke Ranch Rd/ Union St	Agriculture/ Single Family Residential	67,218
2	Scripps Memorial Hospital	2582420200	350 SANTA FE DR	Commercial	63,541
3	Collwood Pines Apartments LP	2604201800/ 2604201900/ ...	2134-2340 CAROL VIEW DR	Multi-family Residential	61,158
4	Park Place Bluffs	2607124200/ 2606716200/ ...	1390 EVERGREEN DR	Multi-family Residential	56,225
5	R E L S Inc (Foxpoint Farms)	2546121200	QUAIL GARDENS RD	Agriculture	55,966
6	Skyloft Homeowners	2163327200/ 2163327300/ ...	1753 SKYLOFT LN	Multi-family Residential	30,990
7	Leucadia Seabluff Village	2544300500/ 2544300800/ ...	1750 N HWY 101	Commercial/ Residential	24,952
8	Essex Heights LLC (Cal West Apartments)	2581111400	404 ENCINITAS BLVD	Multi-family Residential	22,792
9	Sterling Family Trust (Ritz Colony Apartments)	2593200600	1190 ENCINITAS BLVD	Multi-family Residential	21,107
10	Seacrest Holdings Corporation (Seacrest Village)	2563404300	211 SAXONY RD	Commercial	20,947
11	Cardiff Cove HOA	2612200800/ 2612201100/ ...	West of Manchester Ave and Hwy 5	Multi-family Residential	18,959
12	Quail Pointe Apartment Homes LP	2593103600	924 ENCINITAS BLVD	Multi-family Residential	18,705
13	Regal View Owners Assoc	2582410100/ 2582410200/ ...	West of Requeza St and Regal Rd	Multi-family Residential	18,269

Table 3-3. Large Water Users in FY 2020

No	User	APN	Address	Account Type	FY 2020 Average Daily Demand (gpd)
14	Pacifico Encinitas Apartment Homes LP	2570404600	1104 GARDEN VIEW RD	Multi-family Residential	17,230
15	Cummings Properties II LLC	2580904000	160 ENCINITAS BLVD	Commercial	16,826
16	944 Regal Road LLC (Aviara Health Care Center)	2582410900	944 REGAL RD	Commercial	16,338
17	Encinitas LTD (Riviera Mobile Home Park)	2561004400	699 N VULCAN AVE	Multi-family Residential	15,853
18	Self-Realization Fellowship	2600220100/ 2600213200/ ...	215 K ST	Public/ Residential/ Commercial	15,531
19	YMCA	2563401100	200 SAXONY RD	Public	15,324
20	Quail Botanical Gardens Foundation Inc	2570202700	230 QUAIL GARDENS DR	Landscaping-Residential	14,949
21	Saxony At Encinitas Ranch HOA	2563305300	668 SWEET PEA PL	Multi-family Residential/ Commercial	14,922
22	West Hampton Cove HOA	2581112800/ 2581112700/...	West of Saxony Rd and Seacrest Way	Multi-family	14,875
23	Sandy Point Homeowners Assn	2612553000/ 2612544600/ ...	2398 WALES DR	Landscaping-Residential	14,527
24	Encinitas Village HOA	2584000400/ 2584000100/ ...	Summer View Cir	Multi-family Residential	13,924
25	Haciendas De La Playa	2580903800/ 2580903700/ ...	Vista Del Rey Dr/Playa Blanca/ Paseo Pacifica	Multi-family Residential	13,885
26	City of Encinitas-Parks	2604301300	1705 LAKE DR	Landscaping-Government	12,565

Table 3-3. Large Water Users in FY 2020

No	User	APN	Address	Account Type	FY 2020 Average Daily Demand (gpd)
27	Golden Eagle Annuity Investment LP (Jolly Clean Giant)	2580903900	102 ENCINITAS BLVD	Commercial	11,790
28	State of California Parks SD Coast District	2610201100	2324 S COAST Highway 101	Government	11,756
29	North Coast Business Park	2581213100/ 2581213400/ ...	511-543 Encinitas Blvd	Commercial	11,637
30	Pinnacle Encinitas LP	2580904100	ENCINITAS BLVD	Commercial	11,239
31	Studio Inn and Suites LLC	2561226100	607 LEUCADIA BLVD	Multi-family Residential	10,876
32	Charter Equity LLC	2581901500/ 2581901600/ ...	701/765/897/937 S COAST Hwy 101 745/9671st St	Commercial	10,803
33	Casitas Del Mar	2540603000	1680 N COAST HIGHWAY 101	Multi-family Residential	10,075
Total					755,752



Legend

- Large Water User
- Parcels

LEUCADIA SEABLUFF VILLAGE

CASITAS DEL MAR HOA

ENCINITAS LIMITED

SAXONY AT ENCINITAS RANCH HOA

SEACREST HOLDINGS CORPORATION

GOLDEN EAGLE ANNUITY INVESTMENT LP

CUMMINGS PROPERTIES II LLC

PINNACLE ENCINITAS LP

HACIENDAS DE LA PLAYA

CHARTER EQUITY LLC

SELF-REALIZATION FELLOWSHIP

SCRIPPS MEMORIAL HOSPITAL

944 REGAL ROAD LLC

CALIFORNIA STATE PARKS

SKYLOFT HOMEOWNERS

STUDIO INN AND SUITES LLC

RELS INC

LF ENCINITAS PROPERTIES LLC

QUAIL BOTANICAL FOUNDATION

WEST HAMPTON COVE HOA

ESSEX HEIGHTS LLC

NORTH COAST BUSINESS PARK

ENCINITAS VILLAGE HOA

REGAL VIEW OWNERS ASSOC

PARK PLACE BLUFFS

CITY OF ENCINITAS-PARKS

COLLWOOD PINES APARTMENTS LP

SANDY POINT HOMEOWNERS ASSN

CARDIFF COVE

RELS INC

PACIFICO ENCINITAS APARTMENT HOMES LP

STERLING FAMILY TRUST

QUAIL POINTE APARTMENT HOMES LP

Infrastructure
ENGINEERING CORPORATION

San Dieguito Water District
Water System Master Plan
FY 2020 Large Water Users

Figure 3-2

3.3. Supply Sources

The District's water supply portfolio consists of local runoff water from Lake Hodges, raw water from San Diego County Water Authority (SDCWA), treated water from SDCWA and recycled water from San Elijo Joint Powers Authority (SEJPA) to offset potable water use. Both raw water sources are treated at the REB Plant which the District jointly owns with the SFID. The District also receives treated imported water from the SDCWA via Twin Oaks Valley Treatment Plant, which treats a blend of State Water Project and Colorado River water, and the Claude "Bud" Lewis Carlsbad Desalination Plant, which is treated ocean water. Treated imported water is typically used only when the REB Plant is shut down for routine annual maintenance.

Lake Hodges (owned by the City of San Diego) captures surface water from the surrounding San Pasqual Valley. Raw water from Lake Hodges can be pumped directly via Cielo Pump Station to the REB Plant. However, due to dynamic water quality fluctuations, raw water from Lake Hodges is typically conveyed to the San Dieguito Reservoir (SDR) for pre-conditioning prior to conveyance to the REB Plant. Therefore, though there is one basic raw water supply in the area, Lake Hodges and SDR provide two distinct local raw water "sources" to the plant. In any single year, the District and SFID share rights to 5,700 AF of the water entering Lake Hodges, which represents 50% of the total hydraulic yield of 11,400 AFY. In addition, any surface water runoff in excess of 11,400 AFY is split between the District and SFID (50%) and the City of San Diego (50%).

The District and SFID jointly own SDR and jointly operate the REB Plant which is a conventional water treatment plant utilizing flocculation/coagulation, sedimentation, and filtration to take local surface water sources and treat them for potable use. SFID and the District respectively own 55% and 45% of the REB Plant while SFID manages the treatment and conveyance facilities for both agencies.

The REB Plant can also treat raw water from SDCWA via its Second Aqueduct Pipeline 5 connection that is located immediately adjacent to the REB plant. Prior to entering the treatment plant, imported raw water from the high pressure aqueduct pipeline is conveyed through the SFID/SDWD's hydroelectric facility to generate electricity. Generated power not used by the plant is sold to San Diego Gas and Electric (SDG&E).

Treated water imported from SDCWA can be blended either upstream or downstream of the REB Plant clear well.

In 2020, approximately 45% of the District's water supply was from local sources (Lake Hodges), while the remaining 55% was from imported (SDCWA).

The District currently uses recycled water purchased from SEJPA to offset potable water use. Recycled water is primarily used to serve the Encinitas Ranch Golf Course, landscaped traffic medians, homeowner association (HOA) common areas, and a number of parks within the District.

3.4. Water Use Trend

The District's historical water supply data of the past ten fiscal years were provided by REB Plant Staff. The historical water supply is compared with the historical billed water use. Figure 3-3 shows the historical water supply and billed water use for the past ten years. The District's water use reduced post 2015 most likely due to the statewide mandatory water conservation regulations during this period. For FY 2017, the billed water use was slightly higher than the water supply most likely due to meter reading errors.

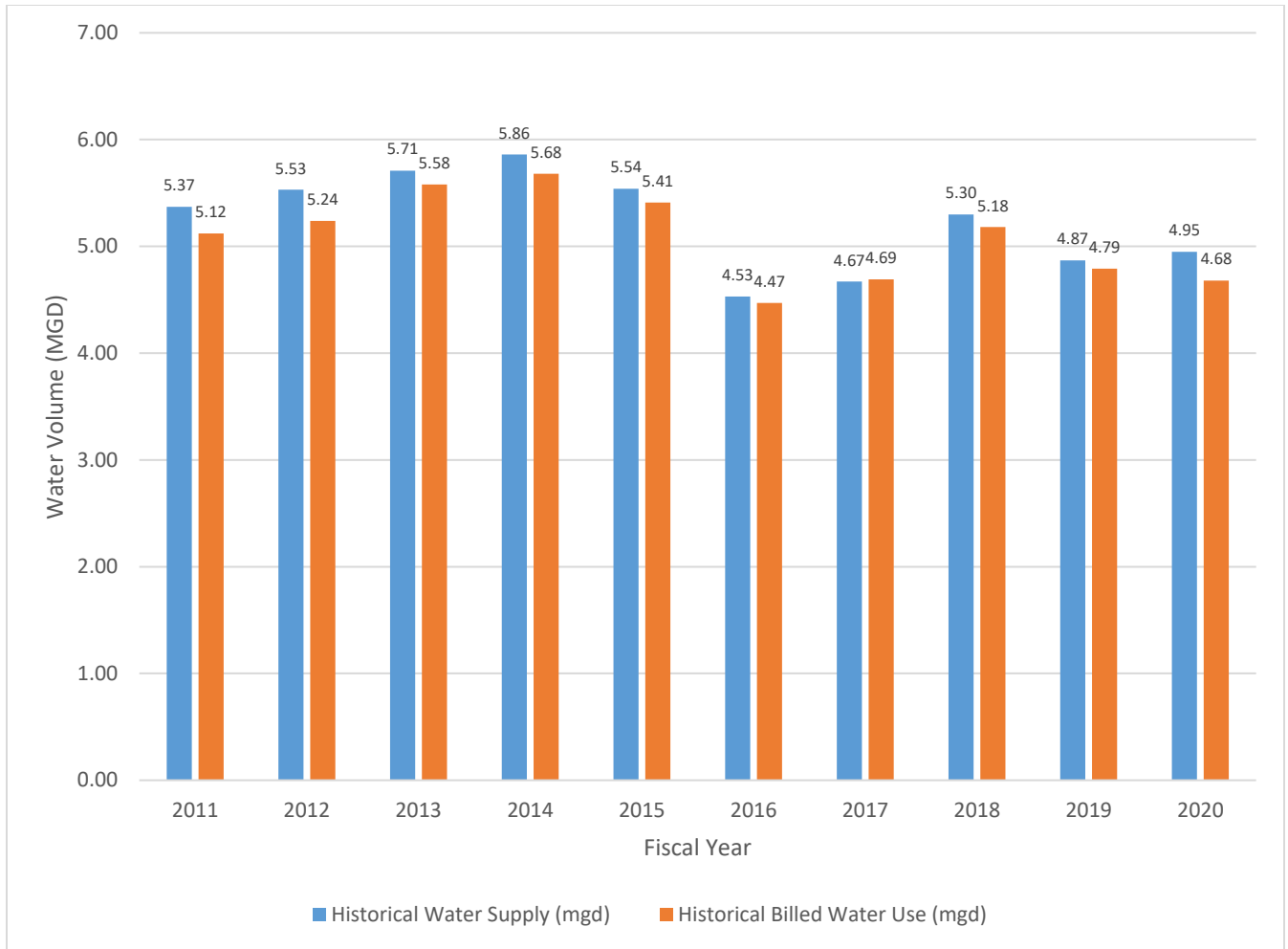


Figure 3-3. Historical Water Supply and Demand

3.5. Existing Water Demands

As shown in Figure 3-3, water use has decreased since 2015. As California continues to implement long-term water conservation and water use efficiency measures to prepare for unpredictable droughts and climate change, making water conservation a way of life in California, demand reduction due to water conservation may be considered permanent. The existing average day demand (ADD) in this Master Plan is estimated by averaging the water supply data of the past 5 years to account for non-revenue water use.

3.5.1. Average Day Demand (ADD)

The existing ADD for the District is estimated to be 4.86 mgd, as presented in Table 3-4. Based on the District’s water supply and billed water use for the past five fiscal years, the District’s average non-revenue water use is approximately 2.7% of water supply.

Table 3-4. Existing Average Day Demand

Fiscal Year	Water Supply (mgd)	Authorized Water Consumption (mgd)	Unauthorized Water Usage (mgd)	% of Unauthorized Water Usage to Water Supply
2016	4.53	4.47	0.06	1.3%
2017	4.67	4.69	-	-
2018	5.30	5.18	0.12	2.3%
2019	4.87	4.79	0.08	1.7%
2020	4.94	4.68	0.26	5.3%
5-Yr Average	4.86	4.76	0.13	2.7%

3.5.2. Max Day Demand (MDD)

The District’s MDD is determined based on the SCADA data of the 36-inch and 30-inch transmission lines from the treatment plant and SCADA data of the storage reservoirs between 7/1/2019 and 10/30/2020. Excluding anomalies in the data, 9/2/2019 is selected to present a MDD with demand of 7.2 mgd and a calculated peaking factor of 1.48 to ADD.

3.5.3. Peak Hour Demand (PHD)

The PHD of 13.27 mgd on 9/2/2019 occurred in the morning at around 7:00 AM, with a calculated peaking factor of 2.73 to ADD.

3.5.4. Diurnal Pattern and Peaking Factors

An hourly system-wide diurnal pattern was developed for MDD based on the SCADA data on 9/2/2019, as shown in Figure 3-4. Recommended peaking factors are presented in Table 3-5.

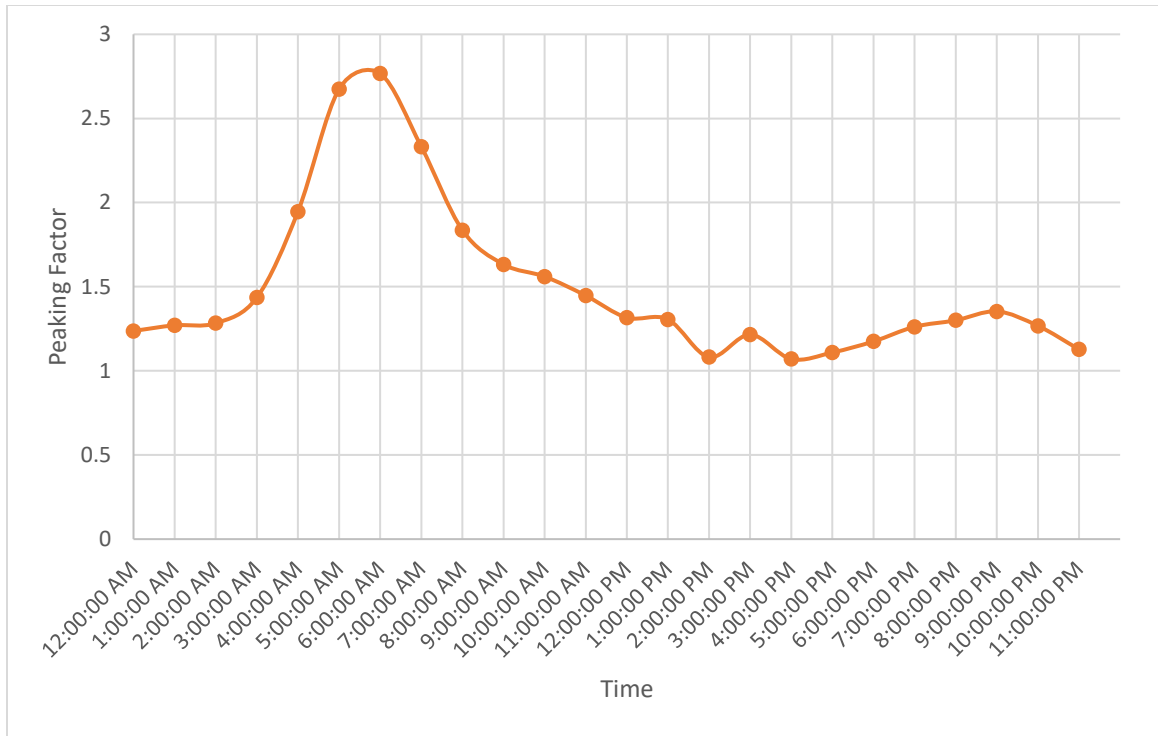


Figure 3-4. MDD Diurnal Pattern

Table 3-5. Recommended Peaking Factors

Demand Scenario	Peaking Factor
MinDD	0.45
ADD	1
MDD	1.50
PHD	2.77

3.6. Future Demands

The District concurrently prepared its 2020 Urban Water Management Plan (2020 UWMP) with the preparation of this Master Plan. The demand projections herein are based on the regional demand projection completed by the SDCWA for the District for its UWMP. The SDCWA’s demand projection model takes into considerations of the historical water use characteristics, anticipated land use changes and population projections that are derived from the SANDAG’s Interim Series 14 model, and water savings through implementation of active and passive conservation measures. Future demands projected for the 2020 UWMP are utilized for this Master Plan, as shown in Table 3-6.

Table 3-6. Water Demand Forecast (AF)

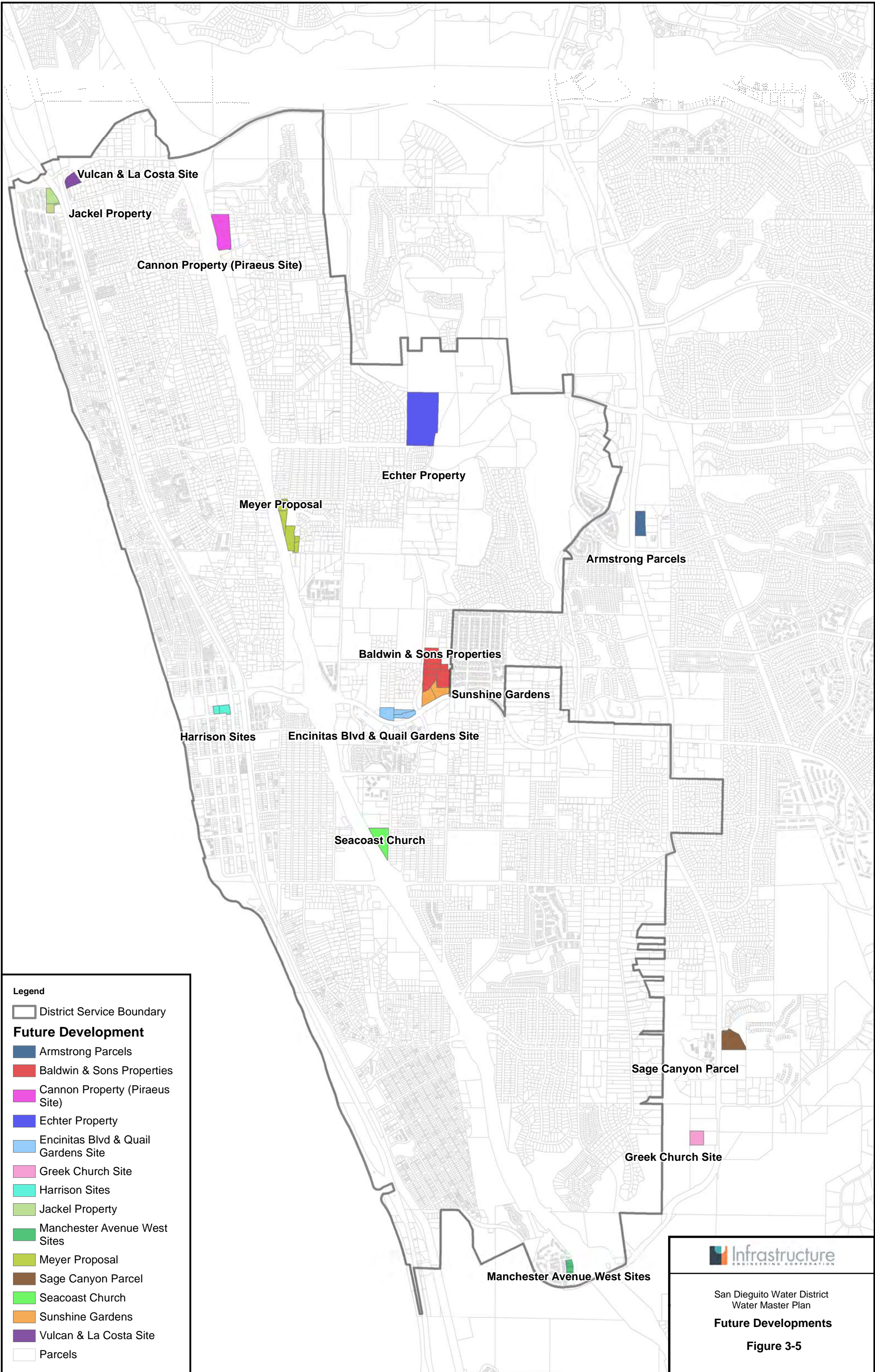
	2025	2030	2035	2040
Baseline Demand Forecast	7,939	8,127	8,270	8,543
Conservation	1,443	1,271	1,327	1,440
Net Total Water Demands	6,496	6,856	6,943	7,103
Recycled Water Demand	700	700	700	700
Potable Water Demand	5,796	6,156	6,243	6,404
Member Agency Local Supplies	2,835	2,835	3,134	3,134
Demand on the Water Authority	3,661	4,021	3,809	3,969

Source: 2020 SDWD UWMP Table 4-2 and Table 4-4

3.6.1. Future Development

The District has identified known future developments within its service areas. Water demands are estimated for each development. Figure 3-5 shows the locations of the known future developments. Table 3-7 presents the proposed development information and demand calculations of the known future developments.

For hydraulic analysis, the development demands are allocated to the nearest model nodes, and the existing demands at the remaining nodes are applied with a background increase factors for 2025 through 2040. Background increase factors are the ratios of background increases to the existing ADD, and background increases are the differences of subtracting the existing ADD and estimated future development demands from the projected water demands.



Legend

- District Service Boundary
- Future Development**
- Armstrong Parcels
- Baldwin & Sons Properties
- Cannon Property (Piraeus Site)
- Echter Property
- Encinitas Blvd & Quail Gardens Site
- Greek Church Site
- Harrison Sites
- Jackel Property
- Manchester Avenue West Sites
- Meyer Proposal
- Sage Canyon Parcel
- Seacoast Church
- Sunshine Gardens
- Vulcan & La Costa Site
- Parcels



 San Dieguito Water District
 Water Master Plan
Future Developments
Figure 3-5

Table 3-7. Known Future Developments

Development No.	Development Name	Proposed Units	Site Area	Dwelling Unit/Gross Ac	Unit Density (Persons/Dwelling unit) ¹	Population	Unit Factor (gpd/capita/day) ²	Development Demand (gpd)	Development Demand (AF)	Development Demand (GPM)
2	Cannon Property (Piraeus Site)	173	6.9	25	3.0	519	150	77,850	87	54.1
5	Encinitas Blvd & Quail Gardens Sites	119	4.5	26	3.0	357	150	53,550	60	37.2
7	Jackel Property	33	3.0	11	3.2	106	150	15,840	18	11.0
9	Echter Property	246	21.5	11	3.2	787	150	118,080	132	82.0
12	Sunshine Gardens	84	3.9	21	3.0	252	150	37,800	42	26.3
AD2	Baldwin & Sons Properties	225	11.8	19	3.0	675	150	101,250	113	70.3
AD8	Vulcan & La Costa Site	50	2.0	25	3.0	150	150	22,500	25	15.6
AD9	Seacoast Church	35	4.4	8	3.5	123	150	18,375	21	12.8
AD11	Manchester Avenue West Sites	41	11.8	3	3.5	144	150	21,525	24	14.9
AD14	Harrison Sites	21	1.9	11	3.2	67	150	10,080	11	7.0
AD31	Meyer Proposal	163	6.5	25	3.0	489	150	73,350	82	50.9
Total		1,190				3,668		550,200	616	382

1. Based on Table 4-1-1 of WAS Design Guidelines

2. Derived from Table 4-1-1 of WAS Design Guidelines

4. Design Criteria

A series of basic assumptions and planning-level design criteria were developed in order to evaluate the District's potable water distribution system. The results of the hydraulic and operational analysis as presented in the System Operations section are evaluated against the design criteria presented below to identify system deficiencies and recommend improvements.

4.1. Distribution System Criteria

Distribution system criteria addresses system pressure and pipeline requirements. These criteria are established to ensure that the proposed distribution system will provide adequate, but not excessive, water pressure and the distribution system can accommodate peak demands without excessive wear or energy usage. It should be noted that the criteria recommended below are planning criteria that are calculated such that they will protect the distribution system under repeated normal operation and enable Class 150 water pipes to be used for construction of the distribution system. These criteria are not recommended to limit, for example, pipeline velocities during intermittent activity such as flushing.

The water distribution system pressure requirements recommended for this hydraulic analysis are as follows:

- Maximum desired pressure: 120 psi
- Maximum allowable pressure: 150 psi
- Minimum allowable pressure at peak flow: 40 psi
- Minimum allowable pressure with maximum day demands plus fire flow: 20 psi

In order to help provide standardization throughout the District, provide adequate fire flows, and avoid excessive velocity and head loss within the distribution system, the following pipeline design criteria are also recommended:

Distribution velocity vs. Transmission velocities

- Minimum pipe size for new construction w/ fire hydrant 8 inches
- Maximum allowable velocity at peak flow: 7 feet per second
- Maximum allowable velocity at peak flow plus fire flow: 15 feet per second
- Maximum desirable head loss at peak flow: 5 feet per 1000 feet
- Maximum allowable head loss at peak flow: 10 feet per 1000 feet

Table 4-1. Distribution System Criteria References

Facility	Criteria	San Dieguito Water District	Carlsbad Municipal Water District (2016 Engineering Standards)	AWWA Manual M32: Computer Modeling of Water Distribution Systems (2019 Edition)	Water Agencies Standards (2014)
System Pressures	Maximum Desired Pressure (psi)	120	125	90	80; 150 (with house regulator)
	Maximum Allowable Pressure (psi)	150	150	110	200
	Minimum Pressure at Peak Flow (psi)	40	40	40-50	40
	Minimum Pressure with Max Day Demands plus Fire Flow (psi)	20	20	20	20
Pipelines	Minimum Pipe Size for New Construction w/ Fire Hydrant (in.)	8	8	-	-
	Maximum Allowable Velocity at Peak Flow (ft/s)	7	8	5	8
	Maximum Allowable Velocity with Max Day Demands plus Fire Flow (ft/s)	15	10	-	10 (15 ft/s for hydrant laterals)
	Maximum Desirable Head Loss at Peak Flow (ft/1000 ft)	5	5	-	-
	Maximum Allowable Head Loss at Peak Flow (ft/1000 ft)	10	10	6	-

As shown in Table 4-1, the District's criteria are similar to those used by the neighboring Carlsbad Municipal Water District and to those recommended by the American Water Works Association (AWWA). The San Dieguito Water District is also a member of the Water Agency Standards (WAS) Committee that has similar applicable design standards for potable and recycled water construction specifications, standard drawings, and approved materials list, that can be found at the WAS website at www.sdwas.org.

By combining maximum head loss requirements with velocity restrictions, the design criteria utilized in the subsequent hydraulic modeling effort more accurately reflect typical distribution system operations than criteria that utilize head loss or velocity criteria alone. By allowing for a reasonable head loss restriction and simultaneously restricting maximum velocities, these criteria allow the District's pipelines to provide adequate flow rates, without excessive wear or energy dissipation.

4.2. Fire Flow Criteria

Fire flow criteria was developed as part of District’s 2000 Master Plan, with required values based upon Insurance Services Office (ISO) standards. These general standards are applied by local jurisdictions such as the District and the City of Encinitas Fire Department. In order to use these ISO standards for the District, the Encinitas Fire Department established minimum fire flows for general building types that apply to new construction and structures with or without fire sprinklers and it is recommended that these values be used for planning-level purposes and for the hydraulic modeling effort, as presented in Table 4-2. Fire flow requirements for proposed developments and new construction, are determined on a case-by-case basis by the Encinitas Fire Department, in compliance with the 2019 California Fire Code (CFC), Title 24, Part 9 Appendix BB.

Table 4-2. District Fire Flow Requirements

Land Use Category	Minimum Required Fire Flow ⁴ (gpm)	Required Duration (hr)
Single Family Residential	1,500	2
Multi-Family Residential	2,500	2
Parks and Public Facilities	2,500	2
Store-front Commercial, Office, and Restaurants	2,500	3
Schools	3,000	3
Commercial Retail and Shopping Centers	3,500	3
Hospitals/Medical Facilities	3,500	3

4.3. Pump Station Criteria

The District has only one emergency pump station that serves the 520 Zone from the Encinitas Ranch Reservoir. This station should be sized to handle maximum day demand (MDD) for the 520 Zone, as well as for the zones being served via pressure reducing stations from the 520 Zone, which includes 345, 395, 409 and 410 zones. The pump station will have a minimum of three (3) pumps, with the station sized to provide the required (firm) capacity, with the largest pump on standby (inactive).

4.4. Storage Criteria

Potable water reservoirs serving the District, including the Badger Clearwell, should provide storage in order to meet four (4) main objectives:

- Moderate fluctuations during normal operations between supply and demand in the distribution system (operational storage: 42% of ADD)
- Provide storage for fire protection to served pressure zones, assuming one fire in the system at a time

⁴ Does not include building sprinkler demands

- Provide water supply during emergencies within the District, when water supply is reduced or turned off (In-District emergency storage: 100% ADD).
- Provide water supply during regional emergencies, when water supply is disrupted from either the San Diego County Water Authority or Lake Hodges (Regional Emergency/Planned Shutdown).

4.4.1. Operational Storage

Under normal operating conditions, operational storage balances the differences between daily water supply and daily variations in demand. Potable water is supplied to the District via the REB Plant. Maintaining sufficient operational, or equalization, storage allows the REB Plant to equalize daily flows and minimize impacts to disinfection contact time in the REB Plant Clearwell.

- The District needs to maintain the difference between maximum day water demands and the maximum demand that can be supplied by the REB Plant. As water demands fluctuate, the District can currently increase supplies directly from the REB Clearwell, up to 11 million gallons per day (MGD) on a maximum day, as per Table 8-10 of the Asset Management Master Plan for the SFID, prepared in March 2009 by Dexter Wilson Engineering (Dexter Wilson Report). This maximum day allocation is anticipated to increase to 18 MGD ultimately, based on the District's 45% capacity ownership, as discussed in Table 8-1 of the Dexter Wilson Report. Currently the District's MDD is 7.2 MGD, which is within the maximum day allocation, thereby no maximum day operational storage needed.
- Per the projected water demand by 2040 and the recommended peaking factor for MDD, the ultimate MDD is estimated to be 8.6 MGD. Ultimately, the REB Plant is anticipated to supply 18 MGD of MDD to the District, well above the projected ultimate MDD for the District. Accordingly, there is no ultimate need for the District to maintain maximum day operational storage.
- The District's operational storage should also be able to balance the difference between PHD and MDD. Assuming eight (8) peak hours of demand, the difference between peak hour and maximum day is $(277\% \text{ of average day demand} - 150\% \text{ of average day demand}) \times 8 \text{ hours} / 24 \text{ hours per day} = 42\% \text{ of average day demand}$ in each pressure zone.

Total Operational Storage = 42% of Average Day Demand

4.4.2. Fire Flow Storage

Fire flow storage requirements are based on the fire flow rate and duration for each hydrant based on the land use type as shown in Table 4-2. This study assumes the system requires enough fire flow storage to fight one fire at a time. Therefore, the required fire flow storage should represent the largest calculated fire flow volume based on land use type using the criteria from Table 4-2. Additionally, fire flow storage must be located in an area of the system such that the distribution system is capable of conveying flows to the area of the system with the highest required fire flows either by gravity, by emergency pumps, or a combination of the two. Based on these criteria, required fire flow storage was calculated as discussed in Section 6.2.

4.4.3. In-District Emergency Storage

The In-District emergencies would typically include supply or power outages, with a relatively short duration. In-District emergency storage should provide enough capacity to give District staff sufficient time to repair facilities and return them to service. Typically, these in-District emergencies can be rectified within a few days.

In addition to maintaining partial ownership of the REB Plant and access to substantial raw water reserves, the District also has access to a filtered water SDCWA connection and several emergency interconnections with the Olivenhain Municipal Water District (OMWD). As such, the District maintains several water supply options in an emergency. With the recent addition of a parallel 54" transmission supply pipeline from the REB Plant, there are few in-District emergencies which could jeopardize the District's ability to deliver treated water to its customers.

In the event of a failure at the REB Plant, treated water could be supplied to the Clearwell by SDCWA. Should the Clearwell need to be removed from service, treated water would be supplied via the Clearwell bypass, with water supply peaks provided from the District's Operational Storage and OMWD emergency inter-connections. As presented in Table 8-1 of the Dexter

Wilson Report, the District has capacity rights for 12.15 MGD of SDCWA treated water in the event of an emergency. This is larger than the District's existing and projected future MDDs

In the event that treated water supply from the REB Plant and SDCWA are both interrupted, or in the event that both high pressure distribution mains are disrupted, it is recommended that the District maintain one (1) ADD of emergency storage, which in conjunction with the District's emergency interconnections with neighboring agencies and emergency conservation efforts, would provide sufficient storage and supply until the In-District emergency is mitigated.

4.4.4. Reserve/Emergency Storage

The SDCWA schedules planned shutdowns between December 1 and March 31 each year to perform routine maintenance on their transmission pipelines. While the timing and duration of these shutdowns is varied, the SDCWA requires that each member agency have ten (10) days of storage capacity for use during these planned shutdown periods. The District complies with this request as there is 134 MG of untreated water storage available to the REB Plant via the San Dieguito Reservoir and Lake Hodges, as presented in Table 8-7 of the Dexter Wilson Report.

It is critical to note that this required ten (10) days of storage, or 134 MG, is provided to the District through their co-ownership of REB Plant. Should the District ever remove the REB Plant from service, and decide to purchase more treated water from SDCWA, the District would be required to provide ten (10) days of storage for planned shut-down periods. Accordingly, the District would be required to obtain additional property, as well as construct and maintain the additional storage reservoirs, which may pose significant water quality problems during periods of low use during the winter.

5. Hydraulic Model Verification

This section addresses the update and refinement to the District's existing hydraulic model. The updated hydraulic model was used for hydraulic analysis and evaluation of the system to accommodate existing and future demands.

5.1. Model Description

The hydraulic model of the SDWD potable water distribution system used for the 2022 Master Plan update is based on the model previously updated for the 2010 Master Plan (2010 model). The 2010 Master Plan Model is an all-pipes model in InfoWater, originally distributed by MWHSoft. For the 2022 Master Plan update, the 2010 model was converted to the latest version of InfoWater available at the time (InfoWater Suit 12.4, Update #5). InfoWater software is currently distributed by Innowyze.

The 2010 model was updated with approximately 2.8 miles of distribution system pipeline which was installed or replaced in the District distribution system since the 2010 model was developed. These pipeline updates were based on the most recent District GIS data. The resulting model is an all-pipe distribution system model representing system updates through approximately 2020.

Reservoirs in the District system have not changed since the 2010 Master Plan update, with the exception of the Wanket reservoir which has been offline for several years. Valves and valve settings in the distribution system have not experienced significant changes since the 2010 Master Plan, with the exception of flow control valves used to control levels in the Encinitas Ranch and Balour reservoirs which are adjusted seasonally.

Existing system model demands were updated based on the demand analysis discussed in the Existing Water Demands and Trends section and allocated to the model based on meter location. Future system demands were based on 2040 demand projections discussed in the Water Demand Projections section and allocated to the model spatially. The diurnal pattern for all model demands was updated based on the diurnal curve shown in Figure 3-4.

5.2. Boundary Conditions

The District hydraulic model includes the R E Badger Filtration Plant (REB Plant) as the sole water supply source for the system. The REB Plant feeds the District system via a clear well which is shared by the Santa Fe Irrigation District (SFID), with SFID owning 55 percent capacity and District owning 45 percent. The clear well has a spill level elevation of 520 feet and a base level of 494 feet. Operators do not allow the clear well to drop below a level of 15 feet, as operations are disrupted if the level drops below 13 feet.

Hydraulically, the District system is affected by the hydraulic grade of the REB Plant clear well and valves which control flow to the Encinitas Ranch and Balour reservoirs. Therefore, the clear well boundary condition is represented in the model by a reservoir with head varying based on the seasonal operational scenarios included in the model.

Under minimum demand conditions during the winter, the clear well level typically varies between 16 and 20 feet, with the operations goal of keeping the level around 19 feet. Under high demand conditions during the summer, operators typically fill the clear well to one foot below spill level overnight (25 feet) with the level dropping to around 17 feet by noon due to the high morning demands on the District and SFID systems. The hydraulic model was updated to include these clear well levels in the ADD, MDD, and MinDD model scenarios.

5.3. Operational Verification

Around June 2020, system operations were changed to fluctuate Encinitas Ranch levels between 14 and 16 feet and Balour reservoir levels slightly lower between 11 and 15 feet. This operational strategy was intended to reduce the residence time in the larger Encinitas Ranch reservoir by inducing flow from this reservoir to the lower volume Balour reservoir, each of which share the same base elevation.

The hydraulic model was updated to represent these tank level operational changes, by adjusting the operational logic for the valves controlling flow from the REB Plant to each reservoir. The model was run with the updated operational logic to demonstrate that model tank levels generally represent tank levels in the actual system.

Figures 5-1 and 5-2 provide a comparison of model tank level results with tank level SCADA data following the operational adjustment over a weeklong period. Model results indicate similar tank level patterns between model results and SCADA data for both the Encinitas Ranch reservoir and the Balour reservoir, indicating that the model is valid for operational analysis.

Figure 5-1. Encinitas Ranch Reservoir Tank Level Model Validation

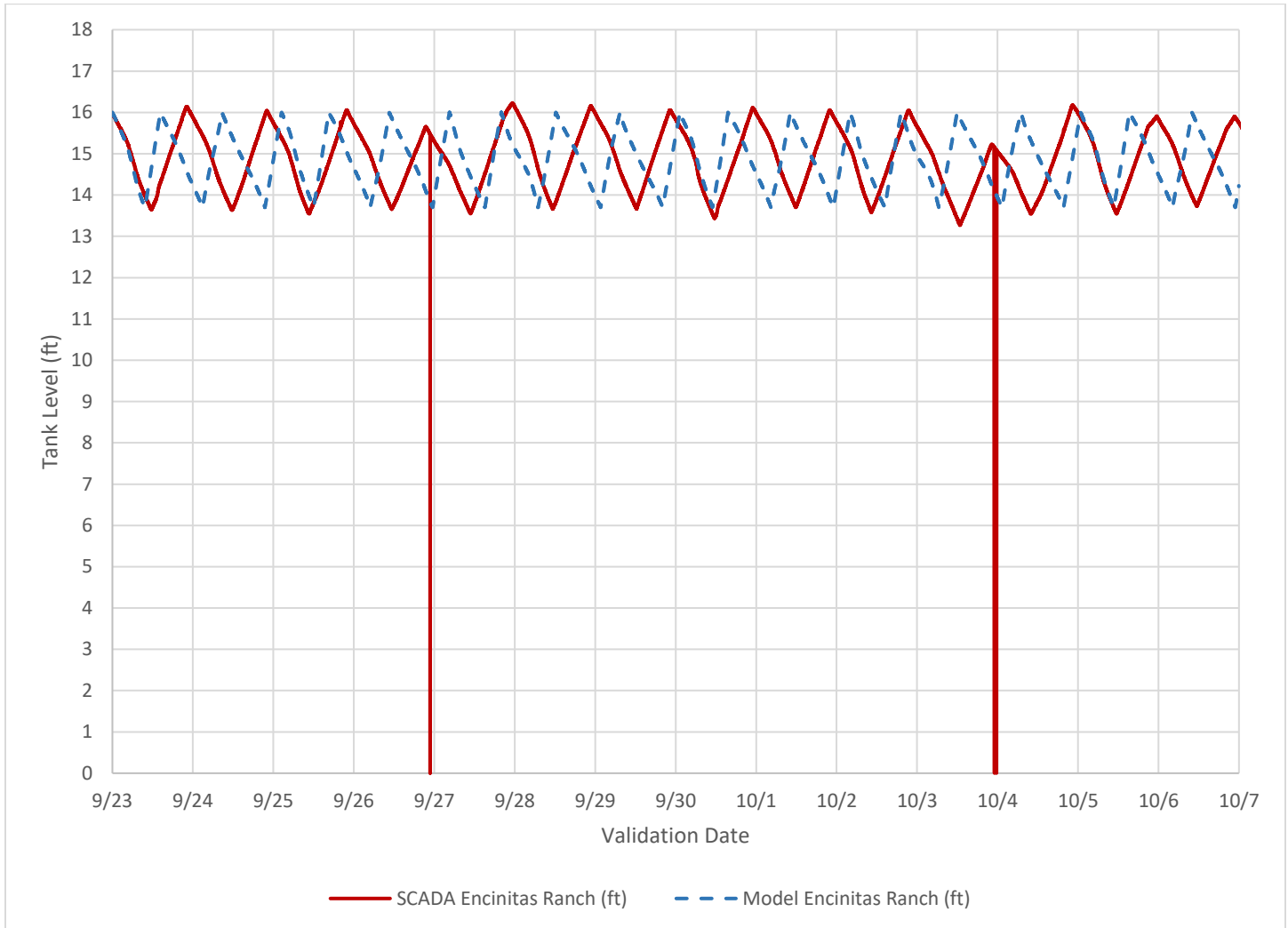
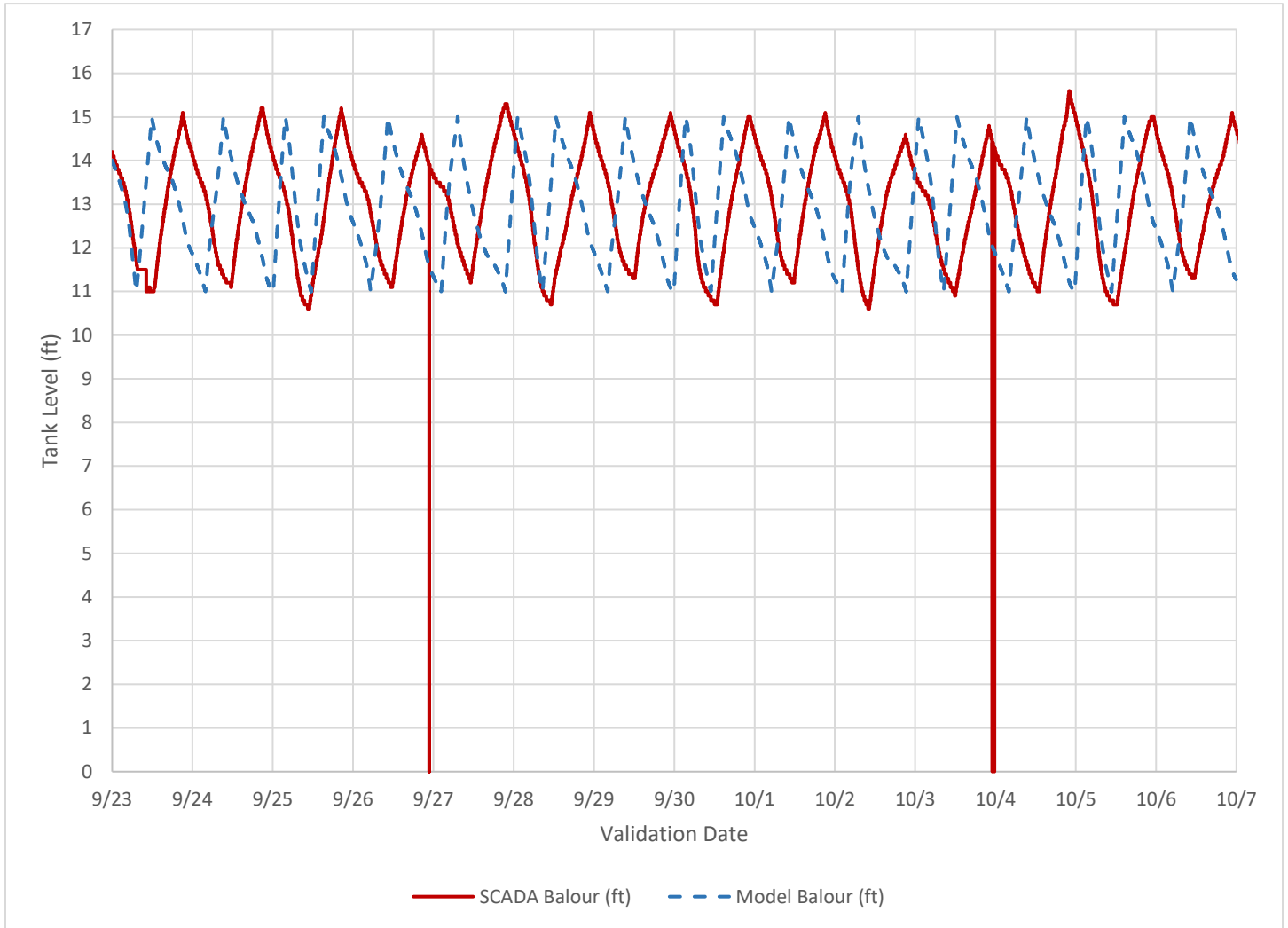


Figure 5-2. Balour Reservoir Tank Level Model Validation



6. System Operations Assessment

This section presents findings from the system evaluation based on hydraulic model simulations and desktop analysis. Descriptions of system deficiencies when compared to recommended planning criteria are also discussed.

6.1. System Hydraulic Evaluations & Model Results

All hydraulic model results were evaluated against the recommended design criteria to identify system deficiencies for the existing and future (2040) demand conditions.

6.1.1. Existing System Analysis

The following four Steady-State (SS) and two Extended Period Simulation (EPS) scenarios were created to model the existing water demands:

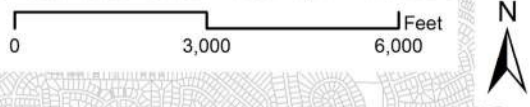
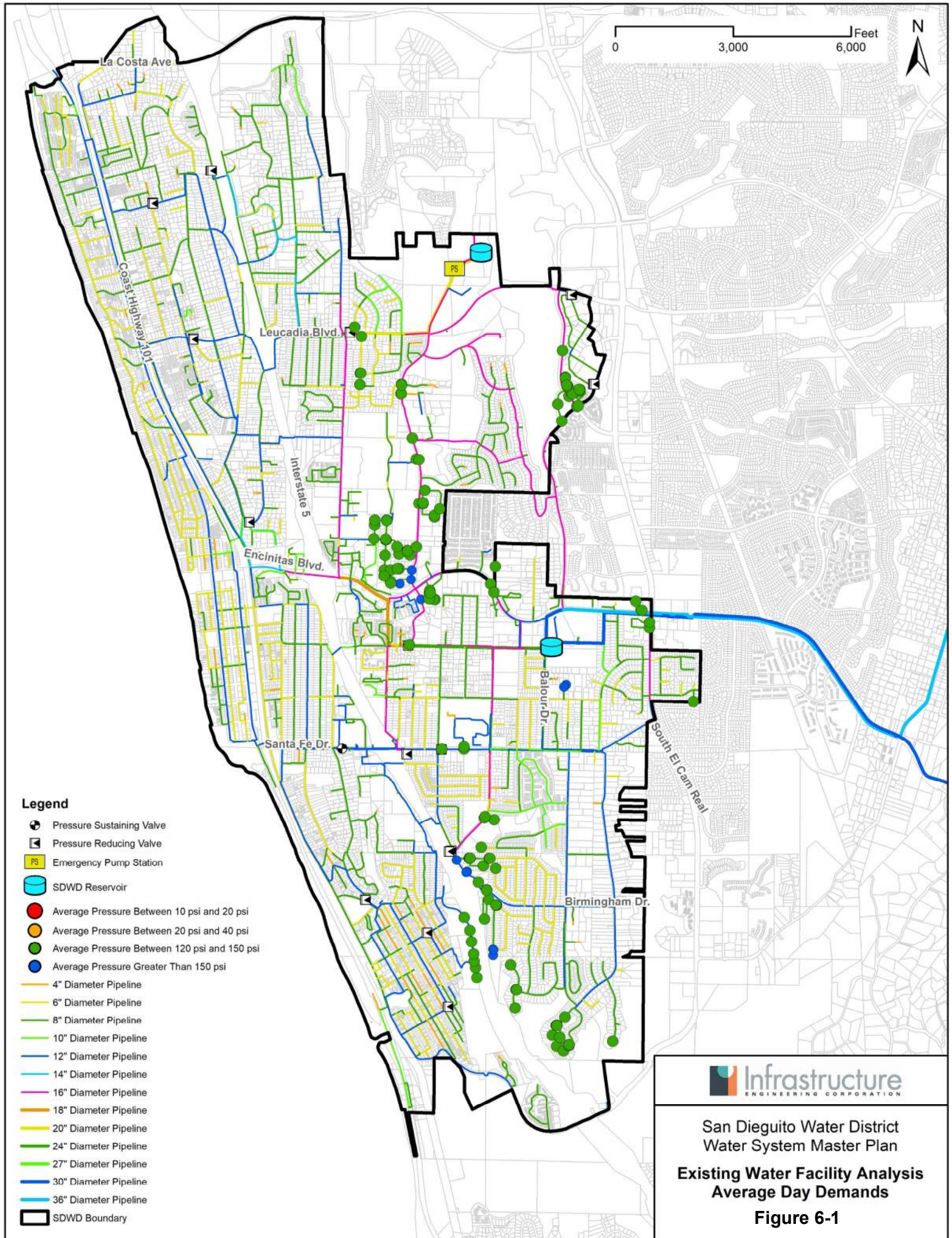
- Average Day Demand with Full Tanks (SS)
- Maximum Day Demand (SS)
- Peak Hour Demands (SS)
- Maximum Day Demands plus Fire Flow (SS)
- 24-hour Maximum Day Demands (EPS)
- 10-day Minimum Water Age (EPS)

6.1.1.1. Existing Average Day Demands

In this steady-state scenario, average daily water demands were allocated to the appropriate hydraulic model junction with all tank levels at maximum height. Currently, there are twelve (12) model demand junctions which are unable to satisfy the District's maximum pressure criteria of 150 psi, as shown in Figure 6-1. These high pressure junctions are located in the 520 pressure zone, most of which experiences a head of 520 feet during the ADD model simulation. These locations experience higher pressures due to lower elevation with all the junctions having an elevation of 173 feet or less. Model results also indicate 122 model demand junctions that experience pressures higher than the desired 120 psi criteria, with the majority of these junctions located in the 520 zone. Seven (7) of these junctions are located in lower pressure zones and experience the higher pressures as a result of low elevation relative to the pressure zone hydraulic grade.

Model results also indicate that all demand junctions maintain the minimum operational pressure criteria of 40 psi.

Detailed model results are included in Table A-1 in Appendix A.



- Legend**
- Pressure Sustaining Valve
 - Pressure Reducing Valve
 - Emergency Pump Station
 - SDWD Reservoir
 - Average Pressure Between 10 psi and 20 psi
 - Average Pressure Between 20 psi and 40 psi
 - Average Pressure Between 120 psi and 150 psi
 - Average Pressure Greater Than 150 psi
 - 4" Diameter Pipeline
 - 6" Diameter Pipeline
 - 8" Diameter Pipeline
 - 10" Diameter Pipeline
 - 12" Diameter Pipeline
 - 14" Diameter Pipeline
 - 16" Diameter Pipeline
 - 18" Diameter Pipeline
 - 20" Diameter Pipeline
 - 24" Diameter Pipeline
 - 27" Diameter Pipeline
 - 30" Diameter Pipeline
 - 36" Diameter Pipeline
 - SDWD Boundary



San Dieguito Water District
 Water System Master Plan
**Existing Water Facility Analysis
 Average Day Demands**
Figure 6-1

6.1.1.2. Existing Maximum Day Demands

In this steady-state scenario, average daily water demands were allocated to the appropriate hydraulic model junction with all tank levels at half-full and the appropriate maximum day peaking factor. Currently, there are six (6) model demand junctions which are unable to satisfy the District's maximum desired pressure criteria of 150 psi, as shown in Figure 6-2. All of these high pressure junctions are located in the 520 pressure zone, most of which experiences a head of 520 feet during the MDD model simulation. These locations experience higher pressures due to lower elevation within the zone. Model results also indicate seventy-nine (79) model demand junctions that experience pressures higher than the desired 120 psi criteria, with the majority of these junctions located in the 520 zone. Seven (7) of these junctions are located in lower pressure zones and experience the higher pressures as a result of elevation relative to the pressure zone hydraulic grade.

Model results also indicate that all demand junctions maintain the minimum operational pressure criteria of 40 psi.

Detailed model results are included in Table A-1 of Appendix A.

6.1.1.3. Existing Peak Hour Demands

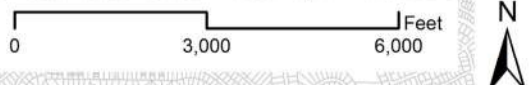
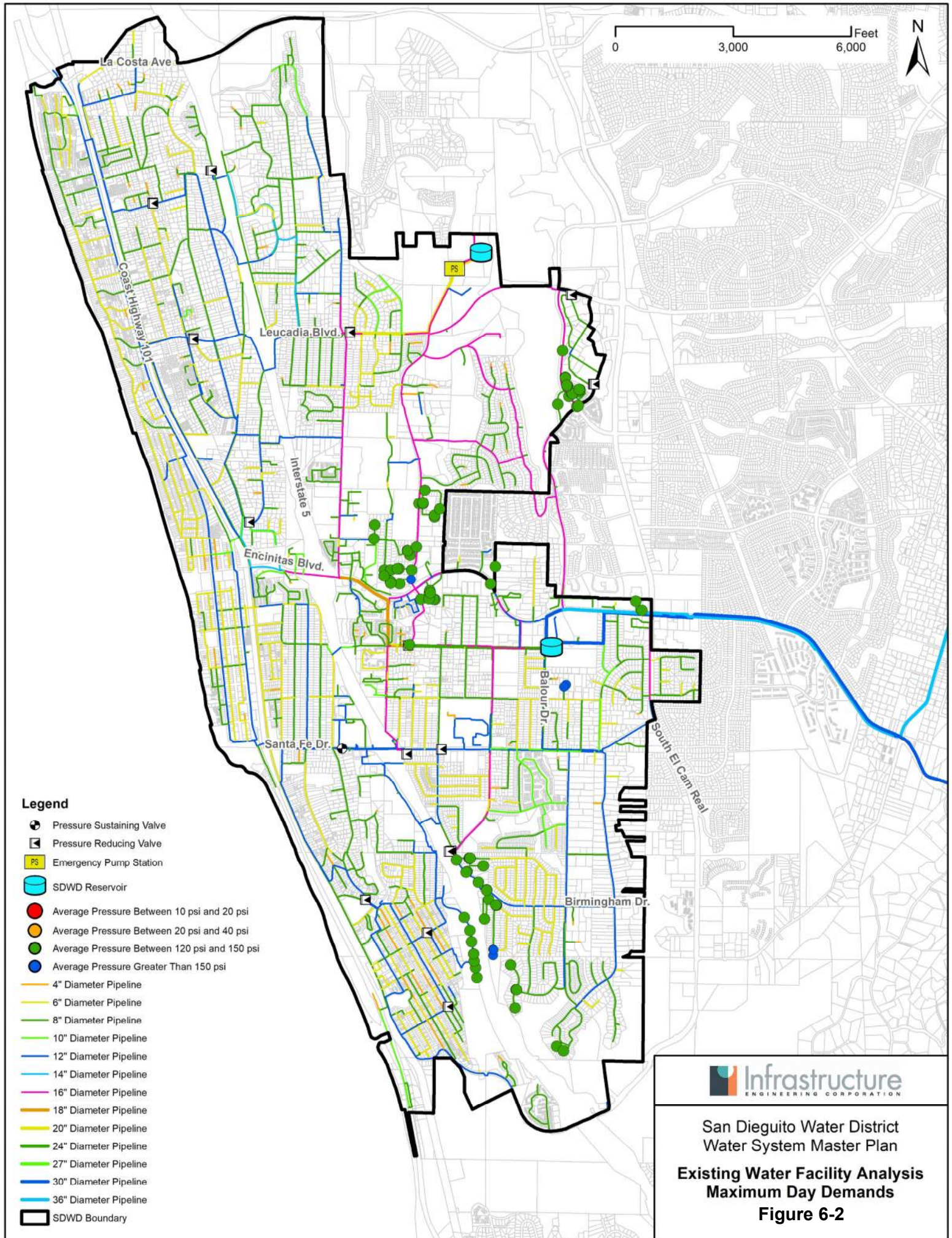
In this steady-state scenario, average daily water demands were allocated to the appropriate hydraulic model junction with all tank levels at half-full and the appropriate peak hour peaking factor. Currently, one (1) demand junction is unable to satisfy the District's minimum allowable pressure at peak flow of 40 psi, as shown in Figure 6-3. This node is located near the Encinitas Ranch Reservoir, therefore, experiences low pressure due to reservoir head

Detailed model results are included in Table A-1 of Appendix A.

6.1.1.4. Existing Maximum Day Plus Fire Flow

Model hydrant nodes were assigned with the required fire flows based on the fire flow criteria discussed in the Design Criteria section above, the ability for each hydrant in the District's service area to deliver the required fire flow during MDD was evaluated. In addition, the District would like to view areas in the system that are vulnerable to wildfires. Areas within the Very High Fire Hazard Severity Zone (VHFHSZ) have fire flow requirement of 2,500 gpm. Model hydrant nodes for Single-Family Residential with fire flow requirement of 1,500 gpm within the VHFHSZ were increased to 2,500 gpm.

There are approximately 230 model hydrants unable to meet the recommended pressure and velocity criteria. Seventy-three (73) model hydrant nodes are unable to sustain the required fire flow demand with a minimum residual pressure of 20 psi, as shown in Figure 6-4 and summarized in Table 6-1. All locations can maintain a fire flow above 500 gpm at a residual pressure of 20 psi. Locations of the pressure deficient hydrants are shown in Zoomed in Figures A2-A to A2-M in Appendix A. For those hydrants unable to sustain the required fire flow demand with a residual minimum pressure of 20 psi, the estimated maximum fire flow demand at this residual pressure was predicted using the hydraulic model. Detailed model results are included in Table A-2 of Appendix A. These deficient areas were further evaluated based on locations to make system improvement recommendations. Details of the CIP recommendations are discussed in **Section 8**.

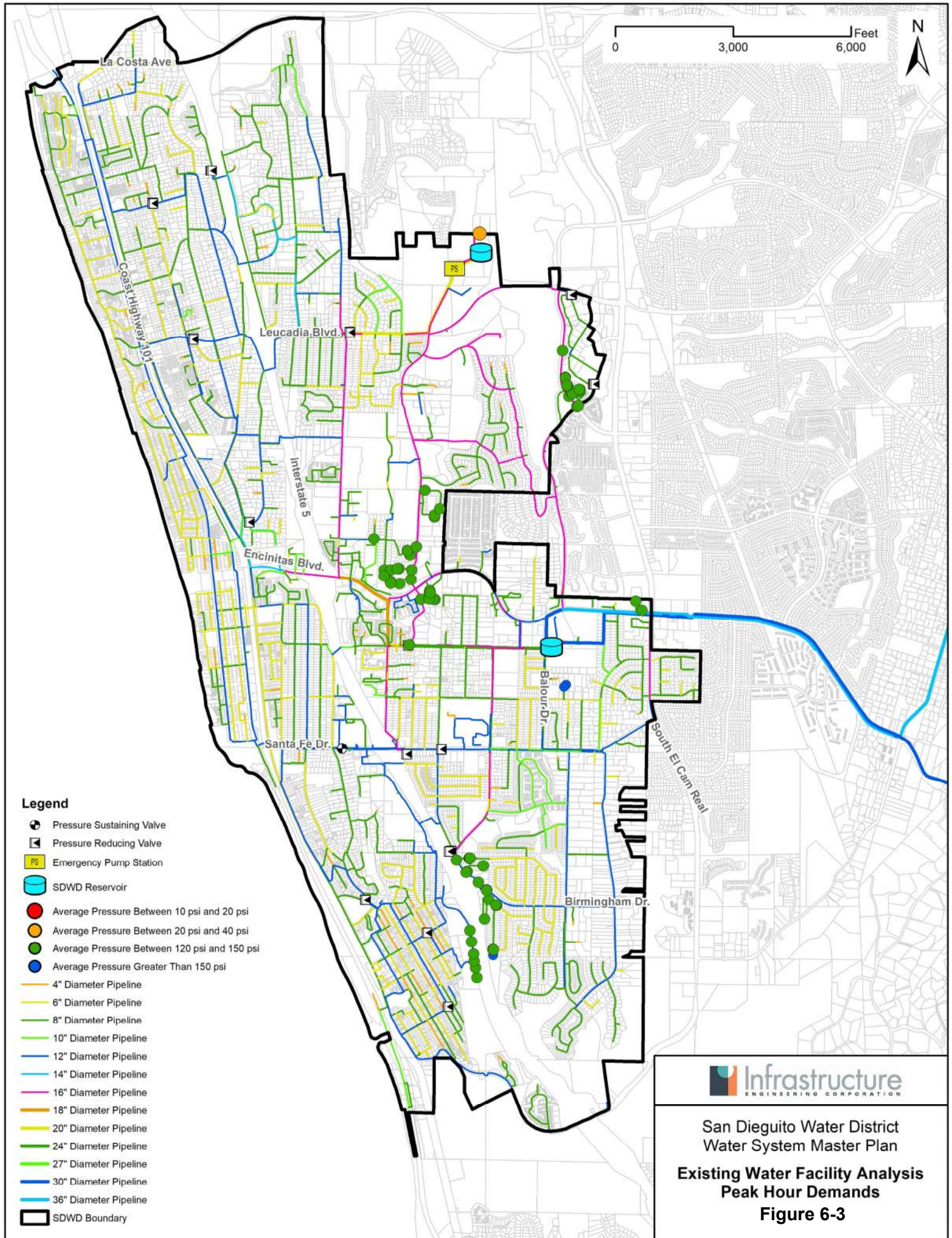


Legend

- Pressure Sustaining Valve
- Pressure Reducing Valve
- Emergency Pump Station
- SDWD Reservoir
- Average Pressure Between 10 psi and 20 psi
- Average Pressure Between 20 psi and 40 psi
- Average Pressure Between 120 psi and 150 psi
- Average Pressure Greater Than 150 psi
- 4" Diameter Pipeline
- 6" Diameter Pipeline
- 8" Diameter Pipeline
- 10" Diameter Pipeline
- 12" Diameter Pipeline
- 14" Diameter Pipeline
- 16" Diameter Pipeline
- 18" Diameter Pipeline
- 20" Diameter Pipeline
- 24" Diameter Pipeline
- 27" Diameter Pipeline
- 30" Diameter Pipeline
- 36" Diameter Pipeline
- SDWD Boundary

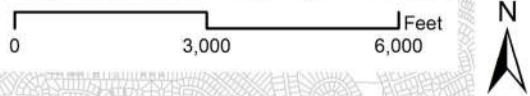


San Dieguito Water District
 Water System Master Plan
**Existing Water Facility Analysis
 Maximum Day Demands**
Figure 6-2

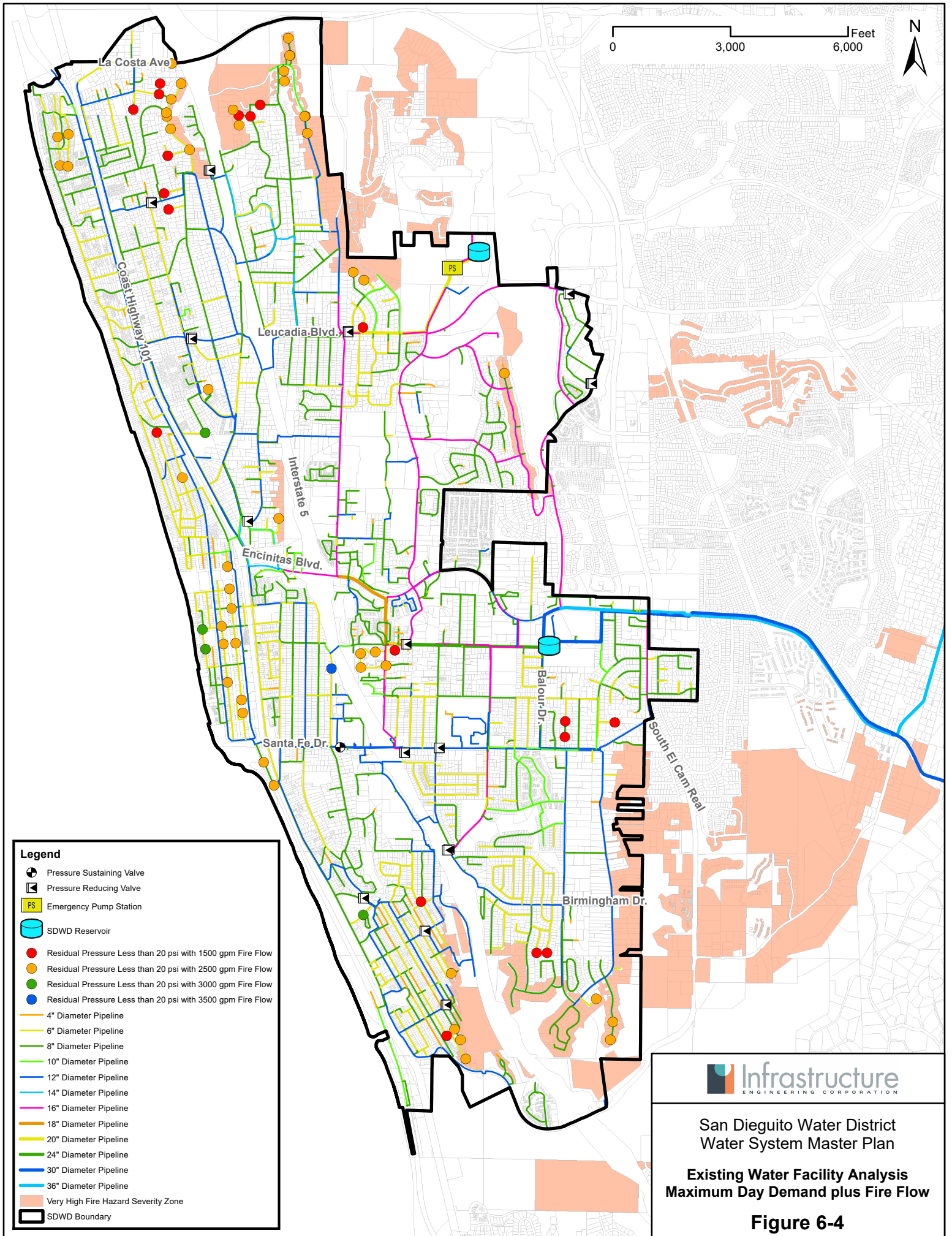


Legend

- Pressure Sustaining Valve
- Pressure Reducing Valve
- Emergency Pump Station
- SDWD Reservoir
- Average Pressure Between 10 psi and 20 psi
- Average Pressure Between 20 psi and 40 psi
- Average Pressure Between 120 psi and 150 psi
- Average Pressure Greater Than 150 psi
- 4" Diameter Pipeline
- 6" Diameter Pipeline
- 8" Diameter Pipeline
- 10" Diameter Pipeline
- 12" Diameter Pipeline
- 14" Diameter Pipeline
- 16" Diameter Pipeline
- 18" Diameter Pipeline
- 20" Diameter Pipeline
- 24" Diameter Pipeline
- 27" Diameter Pipeline
- 30" Diameter Pipeline
- 36" Diameter Pipeline
- SDWD Boundary



San Dieguito Water District
 Water System Master Plan
**Existing Water Facility Analysis
 Peak Hour Demands**
Figure 6-3



Legend

- Pressure Sustaining Valve
- Pressure Reducing Valve
- Emergency Pump Station
- SDWD Reservoir
- Residual Pressure Less than 20 psi with 1500 gpm Fire Flow
- Residual Pressure Less than 20 psi with 2500 gpm Fire Flow
- Residual Pressure Less than 20 psi with 3000 gpm Fire Flow
- Residual Pressure Less than 20 psi with 3500 gpm Fire Flow
- 4" Diameter Pipeline
- 6" Diameter Pipeline
- 8" Diameter Pipeline
- 10" Diameter Pipeline
- 12" Diameter Pipeline
- 14" Diameter Pipeline
- 16" Diameter Pipeline
- 18" Diameter Pipeline
- 20" Diameter Pipeline
- 24" Diameter Pipeline
- 30" Diameter Pipeline
- 36" Diameter Pipeline
- Very High Fire Hazard Severity Zone
- SDWD Boundary



San Diego Water District
Water System Master Plan
Existing Water Facility Analysis
Maximum Day Demand plus Fire Flow
Figure 6-4

Table 6-1. Existing Maximum Day plus Fire Flow Results Summary

Pressure Zone	Total Hydrant Count	Hydrants Failing Pressure Criteria
240	307	24
345	410	24
395	15	1
409	41	8
410	78	4
520	407	12
Total	1258	73

6.1.1.5. 24 Hour Maximum Day Extended Period Simulation

In order to evaluate storage and emergency pumping operations within the District’s potable water distribution system, a 24-hour EPS of MDD was developed. To simulate daily fluctuations in demand, 24-hour diurnal patterns were developed, as presented the Existing Water Demands and Trends section above. By applying these diurnal patterns to MDD, the 24-hour EPS also accounts for the District’s peak hour demand.

This 24-hour maximum day EPS was used to examine the Encinitas Ranch emergency pump station, by simulating a loss of supply from the REB Plant. Model results indicate that the emergency pump station, when operating at its firm capacity of 3,200 gpm (4.61 mgd) with two pumps running has sufficient capacity to supply the 395, 409, 410 and 520 zones under MDD conditions if the REB Plant is offline. The total estimated maximum day demand for the 395, 409, 410 and 520 zones is approximately 3.02 mgd.

The 24-hour MDD EPS simulation did not indicate any system operational issues.

6.1.1.6. 21 Day Minimum Day Extended Period Simulation (Water Quality)

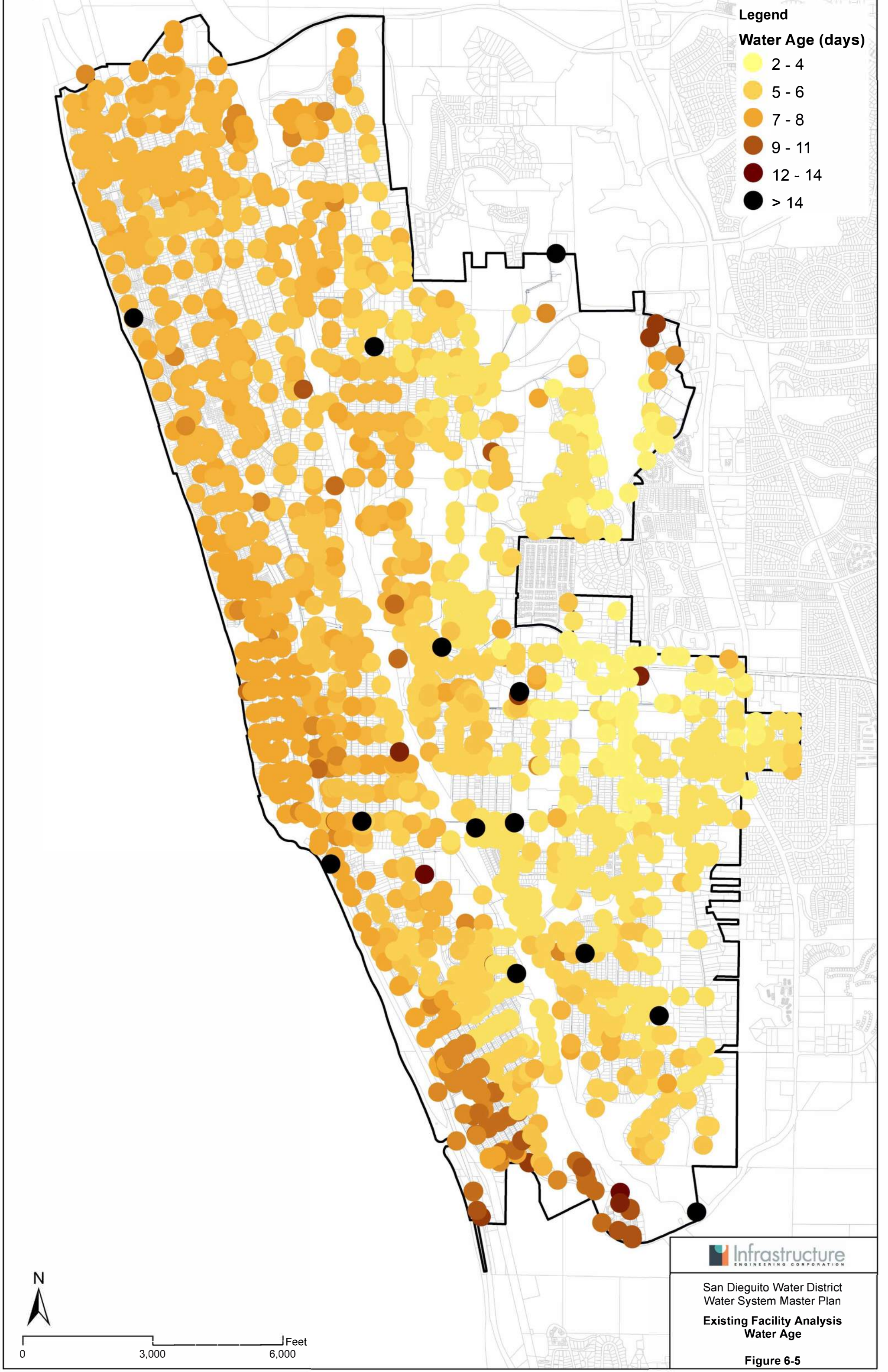
The 21-Day Minimum Day EPS was used to identify potential areas with poor or reduced water circulation, as water quality problems occur predominately during low demand periods, specifically winter months. Water age at each location is calculated considering time of travel in the pipelines, as well as residence time in the storage tanks. Previously presented diurnal patterns were utilized to simulate demand on twenty-one (21) consecutive minimum days, each representing 45% of an average day’s demand. In the beginning of the 21-Day Minimum Day EPS, all water in the District’s distribution system, including storage tanks, is set to zero (0). As the EPS progresses, all initial system water is eventually “purged” from the system through supplying the minimum day water demands and equilibrium water age values can be obtained throughout the system.

The results of this water quality analysis are presented in Figure 6-5 and summarized in Table 6-2. Detailed model results are included in Table A-3 of Appendix A. The operational levels of the Balour and Encinitas Ranch Reservoirs were adjusted to fluctuate between three and five feet, with the age of water in the Balour Reservoir less than four (4) days and the age of water in the Encinitas Ranch Reservoir approximately (5) days. Throughout most of the distribution system, water age is approximately five and a half days old with the age ranging from fifty-four (54) hours to 21 days in dead-end areas of the system. Zones 240, 345, and 410, and 520 all contained at least one model demand node with high water age.

Legend

Water Age (days)

- 2 - 4
- 5 - 6
- 7 - 8
- 9 - 11
- 12 - 14
- > 14



San Dieguito Water District
Water System Master Plan
Existing Facility Analysis
Water Age

Figure 6-5



0 3,000 6,000 Feet

Table 6-2. Existing Minimum Day Demand Water Age Results Summary

Pressure Zone	Existing Water Age (days)	
	Zone Average	Zone Max
240	7.3	21
345	6.0	21
395	8.9	11
409	4.9	8.8
410	4.4	15
520	3.8	21
System	5.5	21

As water quality depends on temperature and chemistry, as well as age, there are no specific criteria for maximum age of water in a distribution system. Areas with a water age of approximately ten (10) days should be, and currently are, included in the District's ultimate U.S. EPA Stage 2 Disinfection By-Products Rule Monitoring Program. Although a water age of ten (10) days during minimum usage times is not excessive, it is these areas which correspond to higher TTHM and HAA5 formation potential, resulting from the chloramination process at the REB Plant. The District's monitoring program of these areas does not indicate excessive water quality issues during low use periods at these locations.

The District uses flushing to address water quality issues in dead-end, low demand areas of the distribution system. Currently, the District is supplying water for a CalTrans construction project near Via Poco and Manchester Avenue which represents a significant demand on the system. Following the completion of this project, the District plans to continue flushing the system near Via Poco and Manchester Avenue to help improve water quality in this area of the system. It is recommended that an automatic flusher be added to the system at the current flushing location on Via Poco to improve water age and related water quality issues in the dead-end area of the system. It is recommended that flushing flow rate and frequency be adjusted based on water quality sampling data until the desired water quality in this area of the system is achieved.

Additionally, model results indicate that connecting lower zones directly to the 520 zone may improve water age in the more isolated areas of the system, such as the 240 zone. Routing flow directly from the 520 zone would allow relatively young water from the REB Plant to enter the 240 zone without the effects of storage in the 345 zone. A project is recommended to connect the 520 zone with the 240 zone via a new PRS by installing approximately 1,000 feet of pipe in Santa Fe Avenue. This project is recommended if using an automatic flusher on Via Poco is not sufficient to mitigate water age related water quality issues in the 240 zone. Additionally, this project is only recommended if the automatic flusher is installed at Via Poco and used to flush the 240 zone. Installing the proposed 520 to 240 zone connection without the automatic flusher could increase water age in the zones between the 520 zone and the 240 zone. Currently, these intermediate zones convey water from the 520 zone to the 240 zone. Short-circuiting the system with a new 520 to 240 zone connection would decrease flow through these zones.

System improvements to address water age are further discussed in Section 8.1.3.

6.1.2. 2040 System Analysis

The following four Steady-State (SS) and two Extended Period Simulation (EPS) scenarios were created to model the projected 2040 water demands:

- Average Day Demand with Full Tanks (SS)
- Maximum Day Demand (SS)
- Peak Hour Demands (SS)
- Maximum Day Demands plus Fire Flow (SS)
- 24-hour Maximum Day Demands (EPS)
- 10-day Minimum Water Age (EPS)

6.1.2.1. 2040 Average Day Demands

In this steady-state scenario, average daily water demands were allocated to the appropriate hydraulic model junction with all tank levels at maximum height. Under 2040 demand conditions, there are twelve (12) junctions which are unable to satisfy the District's maximum desired pressure criteria of 150 psi, as shown in Figure 6-6. All these high pressure junctions are located in the 520 pressure zone, most of which experiences a head of 520 feet during the ADD model simulation. These locations experience higher pressures due to lower elevation with all the junctions having an elevation of 171 feet or less. Model results also indicate 122 model demand junctions that experience pressures higher than the desired 120 psi criteria, with the majority of these junctions located in the 520 zone. Seven (7) of these junctions are located in lower pressure zones and experience the higher pressures as a result of elevation relative to the pressure zone hydraulic grade.

Model results also indicate that no demand junctions drop below the minimum operational pressure criteria of 40 psi.

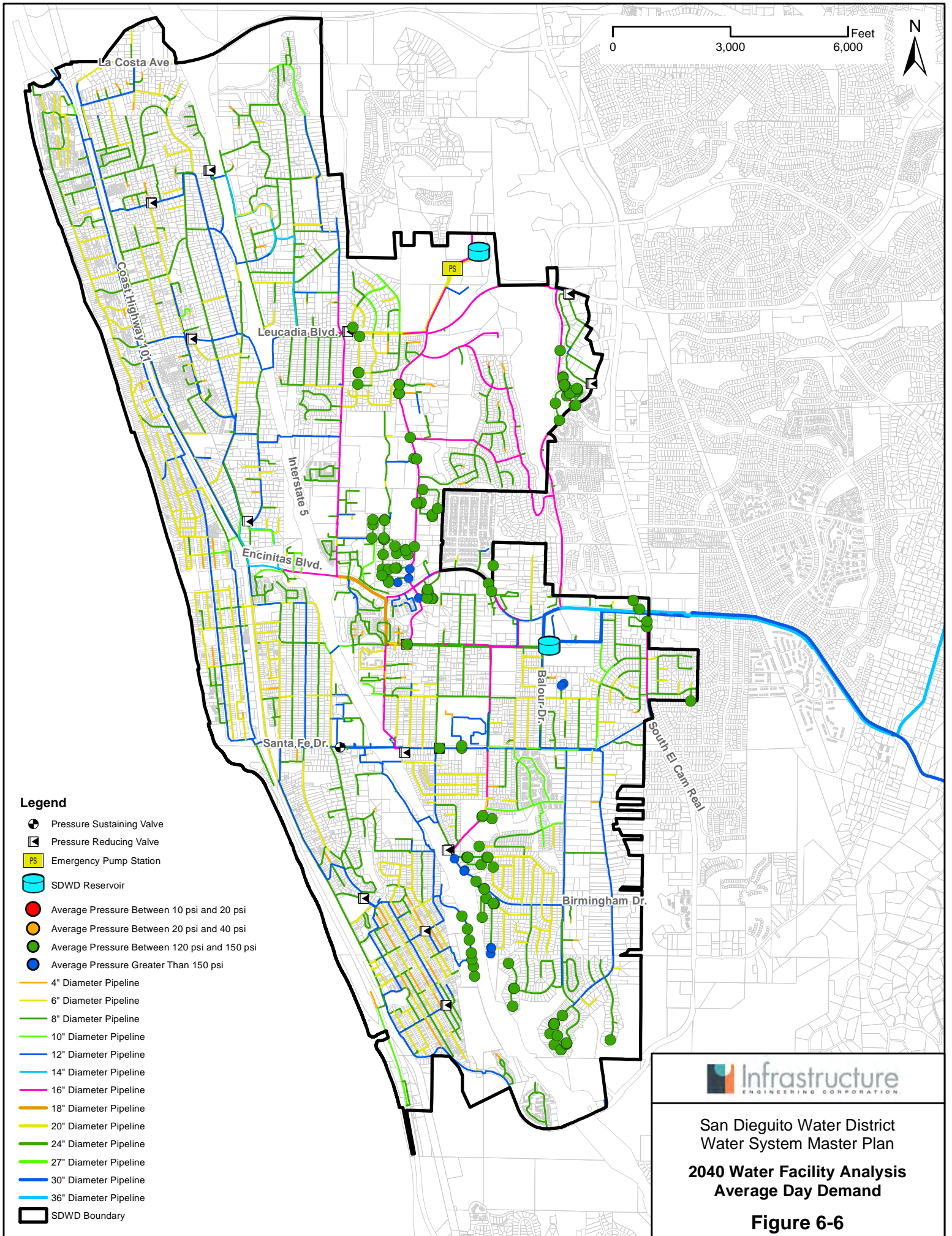
Detailed model results are included in Table A-4 of Appendix A.

6.1.2.2. 2040 Maximum Day Demands























In this steady-state scenario, average daily water demands were allocated to the appropriate hydraulic model junction with all tank levels at half-full and the appropriate maximum day peaking factor. Currently, there are six (6) demand junctions which are unable to satisfy the District's maximum desired pressure criteria of 150 psi, as shown in Figure 6-7. All of these high pressure junctions are located in the 520 pressure zone, most of which experiences a head of 520 feet during the MDD model simulation. These locations experience higher pressures due to lower elevation within the zone. Model results also indicate seventy (72) model demand junctions that experience pressures higher than the desired 120 psi criteria, with the majority of these junctions located in the 520 zone. Six (6) of these junctions are located in lower pressure zones and experience the higher pressures as a result of elevation relative to the pressure zone hydraulic grade.

Model results also indicate that one (1) junction drops below the minimum operational pressure criteria of 40 psi. This junction is located near the Encinitas Ranch Reservoir and its low pressure deficiency is attributed to the geography of the study area, not to excessive headloss.

Detailed model results are included in Table A-4 of Appendix A.



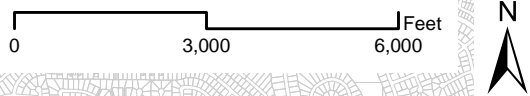
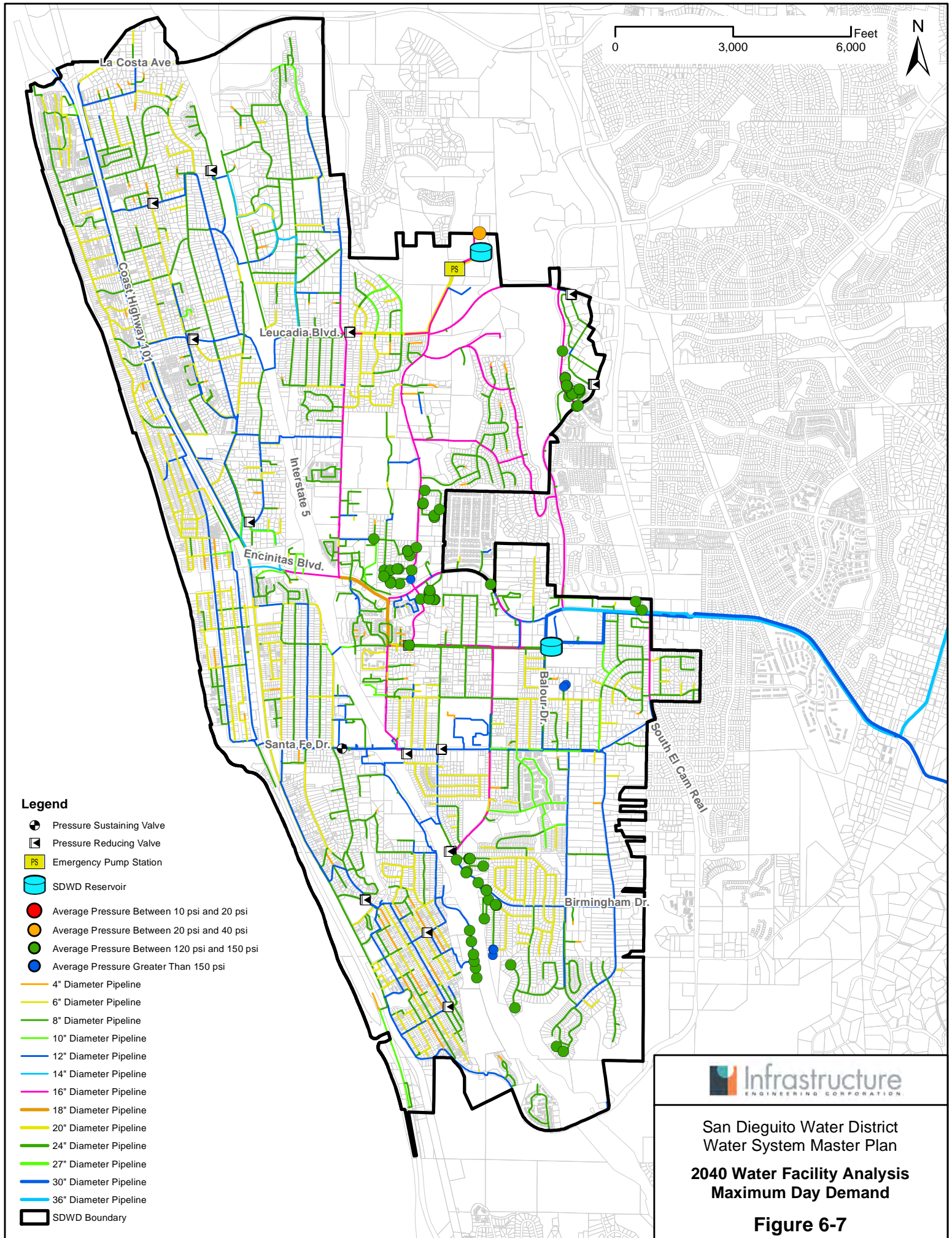
Legend

-  Pressure Sustaining Valve
-  Pressure Reducing Valve
-  Emergency Pump Station
-  SDWD Reservoir
-  Average Pressure Between 10 psi and 20 psi
-  Average Pressure Between 20 psi and 40 psi
-  Average Pressure Between 120 psi and 150 psi
-  Average Pressure Greater Than 150 psi
-  4" Diameter Pipeline
-  6" Diameter Pipeline
-  8" Diameter Pipeline
-  10" Diameter Pipeline
-  12" Diameter Pipeline
-  14" Diameter Pipeline
-  16" Diameter Pipeline
-  18" Diameter Pipeline
-  20" Diameter Pipeline
-  24" Diameter Pipeline
-  27" Diameter Pipeline
-  30" Diameter Pipeline
-  36" Diameter Pipeline
-  SDWD Boundary



San Diego Water District
 Water System Master Plan
 2040 Water Facility Analysis
 Average Day Demand

Figure 6-6



- Legend**
- Pressure Sustaining Valve
 - Pressure Reducing Valve
 - Emergency Pump Station
 - SDWD Reservoir
 - Average Pressure Between 10 psi and 20 psi
 - Average Pressure Between 20 psi and 40 psi
 - Average Pressure Between 120 psi and 150 psi
 - Average Pressure Greater Than 150 psi
 - 4" Diameter Pipeline
 - 6" Diameter Pipeline
 - 8" Diameter Pipeline
 - 10" Diameter Pipeline
 - 12" Diameter Pipeline
 - 14" Diameter Pipeline
 - 16" Diameter Pipeline
 - 18" Diameter Pipeline
 - 20" Diameter Pipeline
 - 24" Diameter Pipeline
 - 27" Diameter Pipeline
 - 30" Diameter Pipeline
 - 36" Diameter Pipeline
 - SDWD Boundary



San Diego Water District
 Water System Master Plan
 2040 Water Facility Analysis
 Maximum Day Demand

Figure 6-7

6.1.2.3. 2040 Peak Hour Demands

In this steady-state scenario, average daily water demands were allocated to the appropriate hydraulic model junction with all tank levels at half-full and the appropriate peak hour peaking factor. Model results indicate five (5) demand junctions are unable to satisfy the District’s minimum allowable pressure at peak flow of 40 psi, as shown in Figure 6-8. One of these model junctions are located near the Encinitas Ranch Reservoir. The remaining three (3) junctions in the 520 Zone are located along a high elevation stretch of Lynwood Drive. One model demand junction in the 240 Zone drops slightly below the minimum operational pressure criteria of 40 psi due to higher elevation within the zone. None of the lower pressure locations are experiencing high friction losses.

Junctions that were unable to satisfy the MDD maximum pressure criteria, were also unable to satisfy the maximum pressure criteria during peak hour demands. No junctions satisfied ADD pressure criteria, which could not also satisfy peak hour pressure criteria.

Detailed model results are included in Table A-4 of Appendix A.

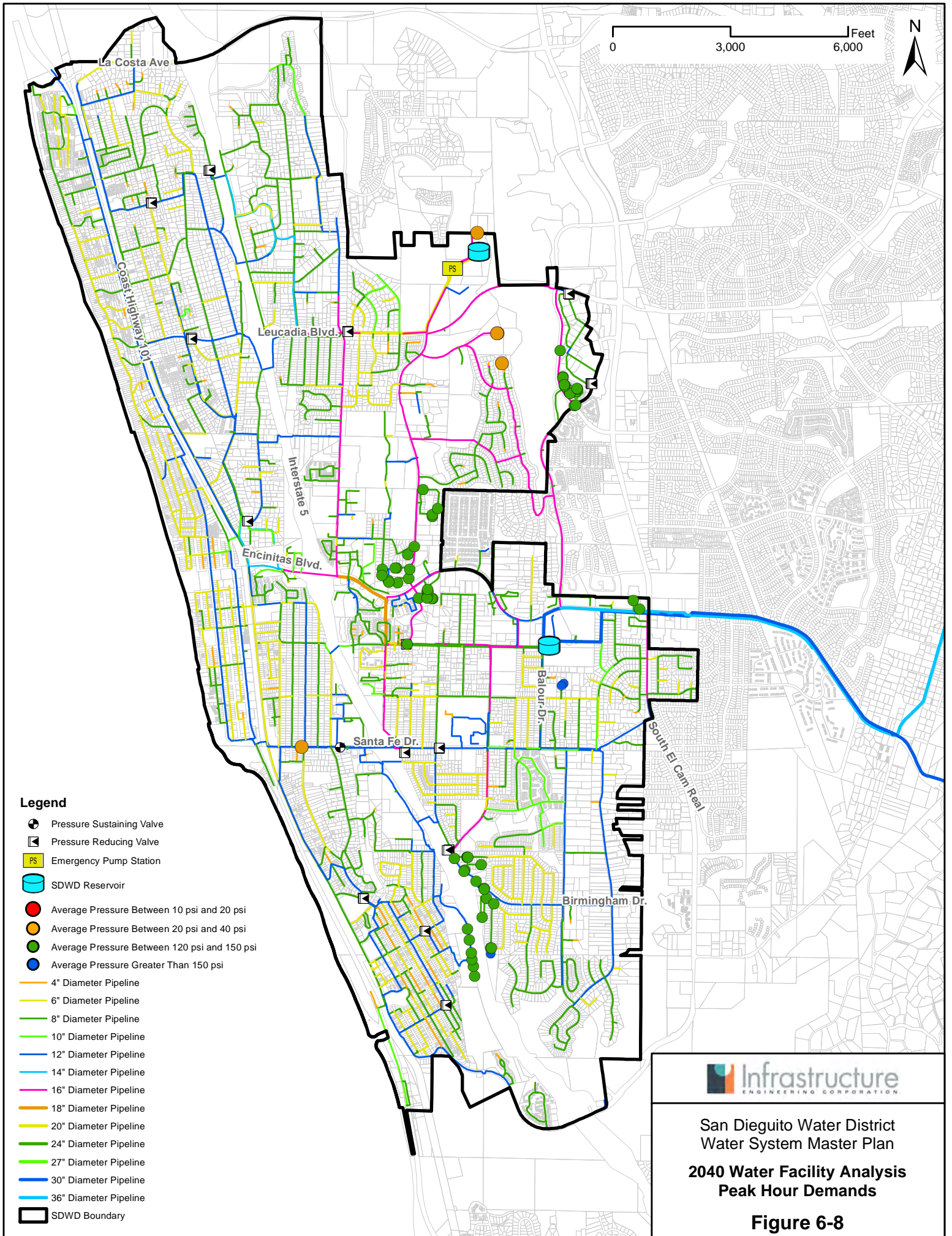
6.1.2.4. 2040 Maximum Day Plus Fire Flow

Model hydrant nodes were assigned with the required fire flows based on the fire flow criteria discussed in the Design Criteria section above, the ability for each hydrant in the District’s service area to deliver the required fire flow during MDD was evaluated. In addition, the District would like to view areas in the system that are vulnerable to wildfires. Areas within the Very High Fire Hazard Severity Zone (VHFHSZ) have fire flow requirement of 2,500 gpm. Model hydrant nodes for Single-family Residential with fire flow requirement of 1,500 gpm within the VHFHSZ were increased to 2,500 gpm.























There are approximately 248 model hydrants unable to meet the recommended pressure and velocity criteria. Seventy-six (76) model hydrant nodes unable to sustain the required fire flow demand with a residual minimum pressure of 20 psi, as shown in Figure 6-9 and summarized in Table 6-3. All locations can maintain a fire flow above 500 gpm at a residual pressure of 20 psi. For those hydrants unable to sustain the required fire flow demand with a residual minimum pressure of 20 psi, the estimated maximum fire flow demand at this residual pressure was predicted using the hydraulic model. Detailed model results are included in Table A-5 of Appendix A. These deficient areas were further evaluated based on locations to make system improvement recommendations. Details of the CIP recommendations are discussed in Section 8.

Table 6-3. 2040 Maximum Day plus Fire Flow Results Summary

Pressure Zone	Total Hydrant Count	Hydrants Failing Pressure Criteria
240	307	24
345	410	25
395	15	1
409	41	8
410	78	6
520	407	12
Total	1258	76



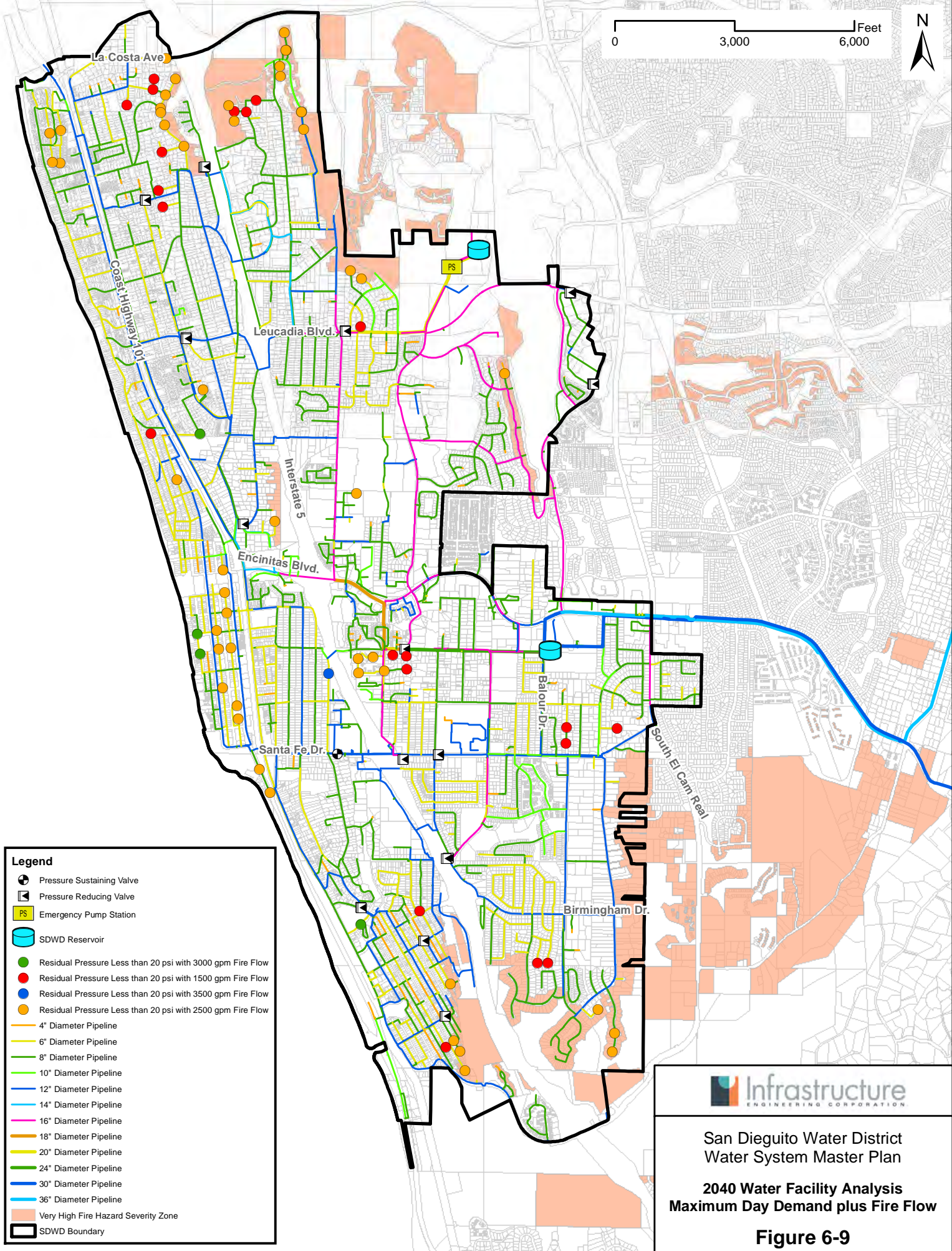
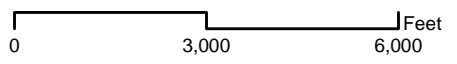
Legend

-  Pressure Sustaining Valve
-  Pressure Reducing Valve
-  Emergency Pump Station
-  SDWD Reservoir
-  Average Pressure Between 10 psi and 20 psi
-  Average Pressure Between 20 psi and 40 psi
-  Average Pressure Between 120 psi and 150 psi
-  Average Pressure Greater Than 150 psi
-  4" Diameter Pipeline
-  6" Diameter Pipeline
-  8" Diameter Pipeline
-  10" Diameter Pipeline
-  12" Diameter Pipeline
-  14" Diameter Pipeline
-  16" Diameter Pipeline
-  18" Diameter Pipeline
-  20" Diameter Pipeline
-  24" Diameter Pipeline
-  27" Diameter Pipeline
-  30" Diameter Pipeline
-  36" Diameter Pipeline
-  SDWD Boundary



San Diego Water District
 Water System Master Plan
 2040 Water Facility Analysis
 Peak Hour Demands

Figure 6-8



Legend

- Pressure Sustaining Valve
- Pressure Reducing Valve
- Emergency Pump Station
- SDWD Reservoir
- Residual Pressure Less than 20 psi with 3000 gpm Fire Flow
- Residual Pressure Less than 20 psi with 1500 gpm Fire Flow
- Residual Pressure Less than 20 psi with 3500 gpm Fire Flow
- Residual Pressure Less than 20 psi with 2500 gpm Fire Flow
- 4" Diameter Pipeline
- 6" Diameter Pipeline
- 8" Diameter Pipeline
- 10" Diameter Pipeline
- 12" Diameter Pipeline
- 14" Diameter Pipeline
- 16" Diameter Pipeline
- 18" Diameter Pipeline
- 20" Diameter Pipeline
- 24" Diameter Pipeline
- 30" Diameter Pipeline
- 36" Diameter Pipeline
- Very High Fire Hazard Severity Zone
- SDWD Boundary

Infrastructure
ENGINEERING CORPORATION

San Diego Water District
Water System Master Plan

2040 Water Facility Analysis
Maximum Day Demand plus Fire Flow

Figure 6-9

6.1.2.5. 24 Hour Maximum Day Extended Period Simulation

In order to evaluate storage and emergency pumping operations within the District’s potable water distribution system, a 24-hour EPS of MDD was developed. To simulate daily fluctuations in demand, 24-hour diurnal patterns were developed, as presented the Existing Water Demands and Trends section above. By applying these diurnal patterns to MDD, the 24-hour EPS also accounts for the District’s peak hour demand.

This 24-hour maximum day EPS was used to examine the Encinitas Ranch emergency pump station, by simulating a loss of supply from the REB Plant. Model results indicate that the emergency pump station, when operating at its firm capacity of 3,200 gpm (4.61 mgd) with two pumps running has sufficient capacity to supply the 395, 409, 410 and 520 zones under MDD conditions if the REB Plant is offline. The total estimated maximum day demand for the 395, 409, 410 and 520 zones is approximately 3.56 mgd.

The 24 hour MDD EPS simulation did not indicate any system operational issues.

6.1.2.6. 21 Day Minimum Day Extended Period Simulation (Water Quality)

The 21-Day Minimum Day EPS was used to identify potential areas with poor or reduced water circulation using the same approach as used in the existing system Minimum Day EPS analysis discussed in the existing system analysis section above.

The results of this water quality analysis are presented in Figure 6-10 and summarized in Table 6-4. Detailed model results are included in Table A-6 of Appendix A The operational levels of the Balour and Encinitas Ranch Reservoirs were adjusted to fluctuate between three and five feet, with the age of water in the Balour Reservoir less than four (4) days and the age of water in the Encinitas Ranch Reservoir less than three (3) days. Throughout most of the distribution system, water age is approximately four (4) days old with the age ranging from forty-one (41) hours to twenty-one (21) days in dead-end areas of the system. Zones 240, 345, and 520 all contained at least one model demand node with high water age of 21 days. The majority of these locations represent dead-end pipes in the model with little or no demand and do not represent systemic water age issues. However, model results do indicate that water age in the southern area of the 240 zone is projected to be relatively higher than other areas of the distribution system. This is a dead-end area of the system with limited looping. The District currently flushes the system at Via Poco and Manchester Avenue. System improvements and operational strategies to address water age are discussed in Section 6.1.1.6 and in Section 8.1.3.

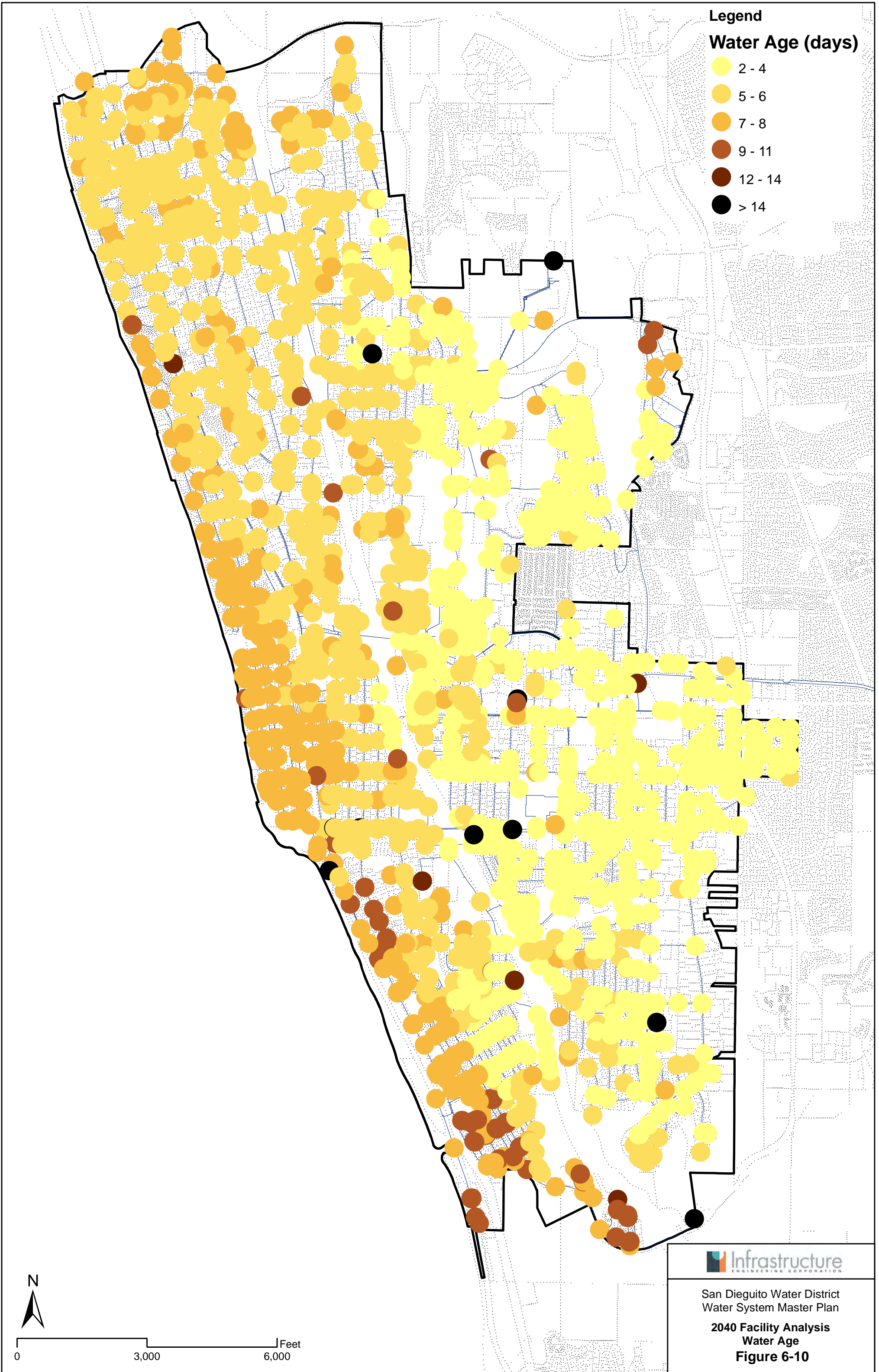
Table 6-4. 2040 Maximum Day plus Fire Flow Results Summary

Pressure Zone	2040 Water Age (days)	
	Zone Average	Zone Max
240	6.3	21
345	5.2	21
395	8.2	10.4
409	4.3	7.6
410	3.9	14
520	3.3	21
System	4.8	21

Legend

Water Age (days)

- 2 - 4
- 5 - 6
- 7 - 8
- 9 - 11
- 12 - 14
- > 14



6.2. Storage Analysis & Operations Usage

A desktop storage analysis was performed to identify storage deficiencies in the distribution system for existing and projected 2040 demand conditions. The analysis was based on the criteria discussed in the Design Criteria section above.

For the purpose for the analysis, the system pressure zones were divided into two separate categories based on the storage facilities providing gravity feed to each zone. The Badger Clearwell gravity feed area includes zones directly fed by the REB Plant or the 520 zone. The Encinitas Ranch/Balour gravity feed area includes the 345 zone, which is directly fed by the Encinitas Ranch and Balour reservoirs, and the 240 zone, which is fed by the 345 zone. The Encinitas Ranch and Balour reservoirs also receive supply from the clearwell via gravity feed. For example, the total storage requirement for zones that are supplied by the Encinitas Ranch Reservoir includes operational storage of 1.2 MG plus emergency storage of 2.85 MG plus fire protection storage of 0.63 MG resulting in 4.86 MG.

The results of the existing system storage capacity analysis indicate adequate storage in the clearwell and the Encinitas Ranch and Balour reservoirs to satisfy the criteria, as shown in Table 6-5. Both gravity feed areas have sufficient storage for operational, emergency, and fire flow storage with an approximate storage surplus of 5.83 MG.

The results for the 2040 storage capacity analysis indicate adequate storage in the clearwell and the Encinitas Ranch and Balour reservoirs to satisfy the criteria without using the emergency fire flow pumps, as shown in Table 6-6. The storage calculations based on 2040 demands indicate a storage requirement of 4.00 MG at the Badger Clearwell. SDWD rights to storage in the Badger Clearwell are limited to 4.00 MG. The storage analysis indicates that the storage in the clearwell can meet the storage requirement with no surplus. The Encinitas Ranch/ Balour gravity feed area has sufficient storage for operational, emergency, and fire flow storage with an approximate storage surplus of approximately 4.62 MG.

The emergency fire pump station is designed to pump water from the 345 zone near Encinitas Ranch reservoir to the 520 zone. The pump station has a firm capacity of 3,200 gpm equating to 0.58 MG of storage over the course of a three-hour fire event per the fire flow criteria.

Table 6-5. Existing System Storage Capacity Analysis Results

Gravity Feed Area ¹	Zone	Average Day Demand (MGD) ⁰	Operational Storage (MGD) (42% ADD)	Emergency Storage (MG) (1 x ADD)	Fire Flow Criteria ²			Total Storage per Area		
					Flow (gpm)	Hours	Storage (MG)	Required (MG) ³	Available by Gravity (MG)	Surplus/Deficit (MG) ⁴
Encinitas Ranch/ Balour	240	1.31	0.55	1.31	3,500	3	0.63	4.68	10.00	5.32
	345	1.54	0.65	1.54	3,500	3	0.63			
	Total	2.85	1.20	2.85	3,500	3	0.63			
Badger Clearwell	395	0.01	0.004	0.01	3,000	3	0.54	3.49	4.00	0.51
	409	0.17	0.07	0.17	3,500	3	0.63			
	410	0.28	0.12	0.28	3,500	3	0.63			
	520	1.55	0.65	1.55	3,500	3	0.63			
	Total	2.01	0.85	2.01	3,500	3	0.63			
Grand Total		4.86	2.04	4.86	3,500	3	0.63	8.17	14.00	5.83

⁰ Demands per pressure zone based on billing account and meter information loaded onto hydraulic model.

¹ Pressure zones are grouped by reservoirs providing nearest gravity feed. The Encinitas Ranch/ Balour gravity feed area also receives gravity feed from Badger Clearwell.

² Largest pressure zone fire flow storage requirement selected to represent required storage for each gravity feed area, assuming one fire at a time and enough time between fires for storage levels to recover.

³ Required storage for each gravity feed area calculated as the sum of all operational and emergency storage requirements for pressure zones in the area plus the largest fire flow storage requirement of the pressure zones.

⁴ Storage analysis indicates sufficient storage for both gravity feed areas of the system.

Table 6-6. 2040 System Storage Capacity Analysis Results

Gravity Feed Area ¹	Zone	Average Day Demand (MGD) ⁰	Operational Storage (MGD)	Emergency Storage (MG)	Fire Flow Criteria ²			Total Storage per Area		
			(42% ADD)	(1 x ADD)	Flow (gpm)	Hours	Storage (MG)	Required (MG) ³	Available by Gravity (MG)	Surplus/ Deficit (MG) ⁴
Encinitas Ranch/ Balour	240	1.47	0.62	1.47	3,500	3	0.63	5.38	10	4.62
	345	1.87	0.78	1.87	3,500	3	0.63			
	Total	3.34	1.40	3.34	3,500	3	0.63			
Badger Clearwell	395	0.01	0.00	0.01	3,000	3	0.54	4.00	4	0.00
	409	0.18	0.07	0.18	3,500	3	0.63			
	410	0.33	0.14	0.33	3,500	3	0.63			
	520	1.86	0.78	1.86	3,500	3	0.63			
	Total	2.37	1.00	2.37	3,500	3	0.63			
Grand Total		5.72	2.40	5.72	3,500	3	0.63	9.38	14	4.62

⁰ Demands per pressure zone based on billing account and meter information loaded onto hydraulic model.

¹ Pressure zones are grouped by reservoirs providing nearest gravity feed. The Encinitas Ranch/ Balour gravity feed area also receives gravity feed from Badger Clearwell.

² Largest pressure zone fire flow storage requirement selected to represent required storage for each gravity feed area, assuming one fire at a time and enough time between fires for storage levels to recover.

³ Required storage for each gravity feed area calculated as the sum of all operational and emergency storage requirements for pressure zones in the area plus the largest fire flow storage requirement of the pressure zones.

⁴ Storage analysis indicates sufficient storage for both gravity feed areas of the system.

6.3. Emergency Interconnects Analysis

A desktop analysis was conducted to estimate the available flow from neighboring agencies through interconnections in the case of an emergency outage. Table 6-7 summarizes the results of the desktop analysis listing estimated available flow from each interconnection based on piping to and from the interconnection point on both the District side and the connecting agency side.

The District currently maintains thirteen (13) interconnections with neighboring agencies, including eleven (11) connecting to Olivenhain Municipal Water District (OMWD) and two connecting to Santa Fe Irrigation District (SFID). Twelve of the interconnections connect to the 520 zone which receives flows from the REB Plant under normal operating conditions. The 520 zone in turn supplies the rest of the distribution system via gravity. One interconnection connects to the 240 zone in the southern end of the system.

Interconnection capacity in the desktop analysis was estimated based on the effective connection size from either side of the interconnection as shown in Table 6-7. Estimated flow rates were calculated assuming 5 fps maximum velocity, per the pipeline criteria shown in Table 4-2, in the smallest pipeline connecting to the interconnection. Resulting estimated interconnection flow rates are shown in Table 6-7.

Based on the estimated maximum flow rates calculated for the interconnections, the District could theoretically accept up to 21 mgd from neighboring agencies, including 17 mgd from OMWD and 3.7 mgd from SFID, more than three times the projected 2040 average day demand of 5.7 mgd. However, additional factors such as neighboring agencies' available supply and hydraulic limitations in neighboring agency distribution systems would likely limit the amount of flow that could be transferred through the interconnections at any one time.

Additionally, some interconnections connect to neighboring agency pressure zones with a lower hydraulic grade than the connecting District pressure zone. None of the interconnections are known to be unidirectional, however connecting to a lower pressure zone under emergency conditions may result in decreased pressures at service connections.

In summary, the District's existing interconnections have a combined hydraulic capacity of more than three times the projected 2040 average day demand. While factors such as available water in neighboring agency systems and system hydraulics would likely limit the amount of water that could practically be transferred to the District's system in the case of an emergency, the interconnections themselves would likely not be the limiting factor in transferring water to the District in the case of an emergency.

Table 6-7. Emergency Interconnects Estimated Flow Capacities

Location	Name	Metered / Unmetered	Meter Information	Effective Connection Size	Connecting Agency	SDWD Pressure Zone	OMWD/SFID Pressure Zone	Approximate Flow Rate ¹ (gpm)	Approximate Flow Rate ¹ (mgd)	Elevation	PSI (UP)	PSI (DOWN)
Encinitas Blvd 200' East of Willowsprings Drive	Willowsprings	Metered	10" & 4" (Sparling)	SDWD 30"	OMWD	520	550	1760	2.53	254	115 (OMWD)	128 (SDWD)
				OMWD 12"								
El Camino Del Norte several hundred feet East of Rancho Santa Fe Rd	Cole Ranch Rd	Metered	UNK	SDWD 36"	OMWD	520	530	440	0.63	92	180 (OMWD)	160 (SDWD)
				OMWD 6"								
Wanket Tank	Wanket (S/E Connection)	Metered	10"	SDWD 12"	OMWD	520	437	1760	2.53	397	70 (OMWD)	47 (SDWD)
				OMWD 12"								
Via Cantabria North of Garden View	Encinitas Town Center (Target Center)	Metered	8" (McCrometer)	SDWD 8"	OMWD	520	437	780	1.12	128	96 (SDWD)	93 (OMWD)
				OMWD 8"								
Delphinium Street at Teaberry Street	Delphinium	Metered	4" (McCrometer)	SDWD 8"	OMWD	520	437	781	1.12	186	136 (SDWD)	100 (OMWD)
				OMWD 8"								
Via Poco & Manchester	Via Poco	Metered	6" & 4" (Sensus)	SDWD 10"	OMWD	240	458	1220	1.76	5	196 (OMWD)	96 (SDWD)
				OMWD 10"								
Via Cantabria at Via Tierra	Via Cantabria at Via Tierra	Unmetered	N/A	SDWD 16"	OMWD	520	550	1220	1.76	358	88 (OMWD)	64 (SDWD)
				OMWD 10"								
S El Camino Real at Santa Fe Drive	S ECR at Santa Fe Drive	Unmetered	N/A	SDWD 12"	OMWD	520	550	780	1.12	269	120 (OMWD)	100 (SDWD)
				OMWD 8"								
337 Oakbranch Drive	Oakbranch	Unmetered	N/A	SDWD 8"	OMWD	520	550	780	1.12	236	135 (OMWD)	115 (SDWD)
				OMWD 8"								
Encinitas Blvd at El Camino Real	1439 Encinitas Blvd	Unmetered	N/A	SDWD 30"	OMWD	520	437	1760	2.53	221	124 (SDWD)	93 (OMWD)
				OMWD 12"								
Via Cantabria at Pacifica Place	Via Cantabria at Pacifica	Unmetered	N/A	SDWD 16"	OMWD	520	437	780	1.12	230	123 (SDWD)	84 (OMWD)
				OMWD 8"								
El Mirlo & Via De Fortuna	El Mirlo & Via De Fortuna	Unmetered	N/A	SDWD 30"	SFID	520	520	1760	2.53	250	110 (SFID)	110 (SDWD)
				SFID 12"								
El Camino Del Norte west of Lome Algre	El Camino Del Norte west of Lome Algre	Unmetered	N/A	SDWD 36"	SFID	520	520	780	1.12	150	168 (SFID)	168 (SDWD)
				SFID 8"								

¹ Flow rates estimated based on 5 fps velocity criteria for connection size.

7. Asset Management Study

San Dieguito Water District (District) owns 168 miles of water main infrastructure with a current replacement cost⁵ of approximately \$490 million dollars. As the system continues to age and deteriorate, one of the District's primary goals is to cost effectively sustain desired service levels. To accomplish this, the District has initiated this effort to continuously improve the way distribution infrastructure is managed. The primary objectives of this project are to:

1. Establish prudent, transparent, and defensible investment levels that will enable the District to sustain desired levels of service as the system continues to age and deteriorate.
2. Focus those investments so that ratepayers realize a greater return on their investment.

An age-based pipeline renewal budget was developed⁶ estimating a need of \$7.8 million dollars per year. However, institutional knowledge and industry expertise suggests that the District's infrastructure will last significantly longer than age-based estimates. In order to verify this and develop data driven decision making, data cleansing activities⁷ were performed and documented in **Section 7.1** of this report. Based on District data over the past 17 years, mainline infrastructure break rate performance is 0.8 which is twenty times better than the national average and twelve times better than the regional average⁸. Break rate is defined as the annual breaks per 100 miles of pipe per year. Compared to other utilities in California, the District is within the top quartile of utilities in terms of break rate. The District's performance is likely due to good design⁹ and operational practices to minimize pressure surges and soil conditions that are particularly amenable to longer useful life in the prominent materials in the District's system. However, Figure 7-1 shows the District's break rates are increasing as infrastructure continues to age and deteriorate indicating that additional investments may be needed to sustain existing service levels.

In an effort to establish prudent, transparent, and data driven investment levels that extend the life of existing infrastructure, a benchmarking effort was initiated to compare District performance and investment levels to other similar utilities. This benchmarking effort is documented in **Section 7.2** of this report. Utilities were benchmarked based on break rate and replacement rate measured as the percentage of the system by length replaced annually. Each community must find the appropriate balance between service levels and near-term cost for their community. In general, systems that are performing well do not require significant investment levels. However, as pipes deteriorate and break more often, increased investment in pipeline replacement are warranted. Figure 7-2 quantifies this relationship for the utilities that were benchmarked¹⁰. Based on the District's current break rate performance (break rate of approximately 1.2) and the benchmarking curve, it is estimated that the District should be investing approximately 0.14% of the system-wide replacement cost per year. This is equivalent to approximately \$700,000 dollars per year on aging infrastructure. This is a savings of approximately \$7 million per year when compared to the age-based investment need identified.

⁵ Costs do not include inflation. The pipeline replacement cost includes both construction and soft costs for mains, services, and valves. The cost excludes pressure reducing stations, pump stations, tanks, and other facilities.

⁶ The age-based renewal budget applies District infrastructure installation years and unit costs to published useful life estimates from the America Water Works Association (AWWA) report titled *Buried No Longer: Confronting America's Water Infrastructure Challenge* to determine the average replacement cost over the next 50 years. This cost excludes inflation.

⁷ Data cleansing included identifying and removing non-condition related breaks, associating breaks to the pipe that broke, and filling gaps in pipe installation date.

⁸ The average break rate in California and Nevada is 9.7 per Folkman's 2018 report titled *Water Main Break Rates in the USA and Canada: A Comprehensive Study*.

⁹ The system is primarily gravity fed which limits pressure surges.

¹⁰ City of Carlsbad, Vista Irrigation District, Rainbow Municipal Water District, Sweetwater Authority, Padre Dam Municipal Water District, Helix Water District, City of Buena Park, City of Vernon, Los Angeles DWP, City of Long Beach, San Juan Water District, Contra Costa Water District, East Bay MWD, City of Phoenix, Denver Water

Figure 7-1. District Break Rate History

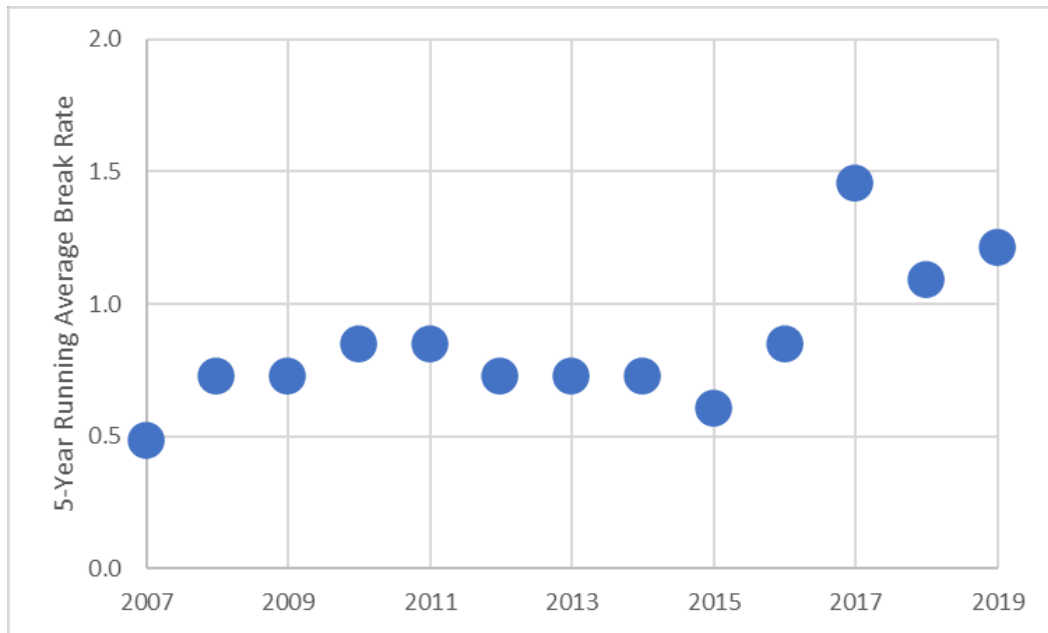
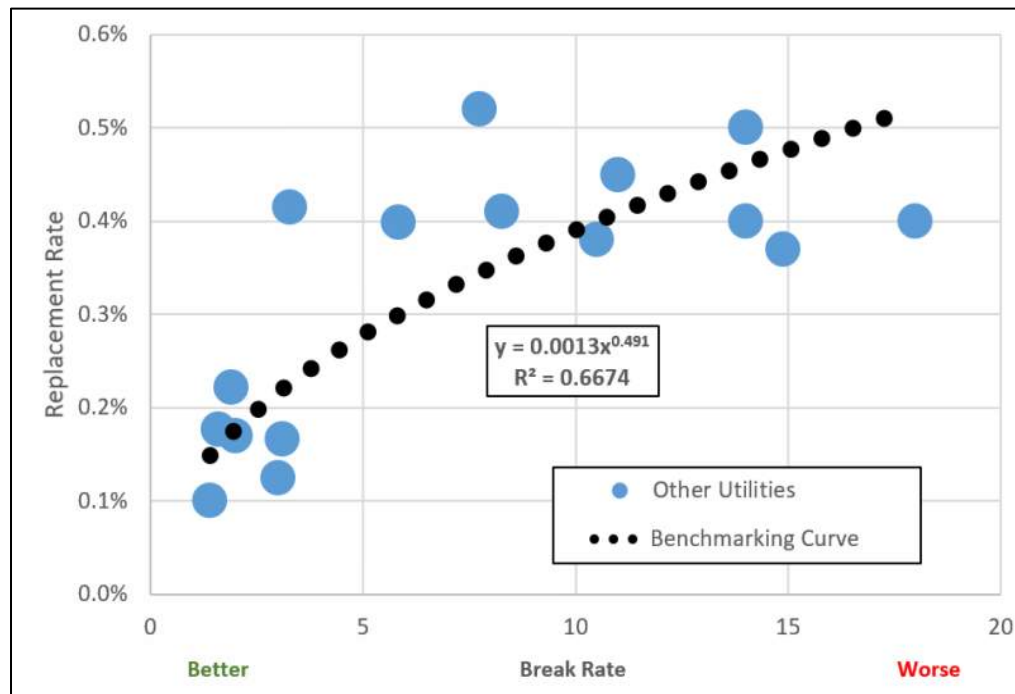
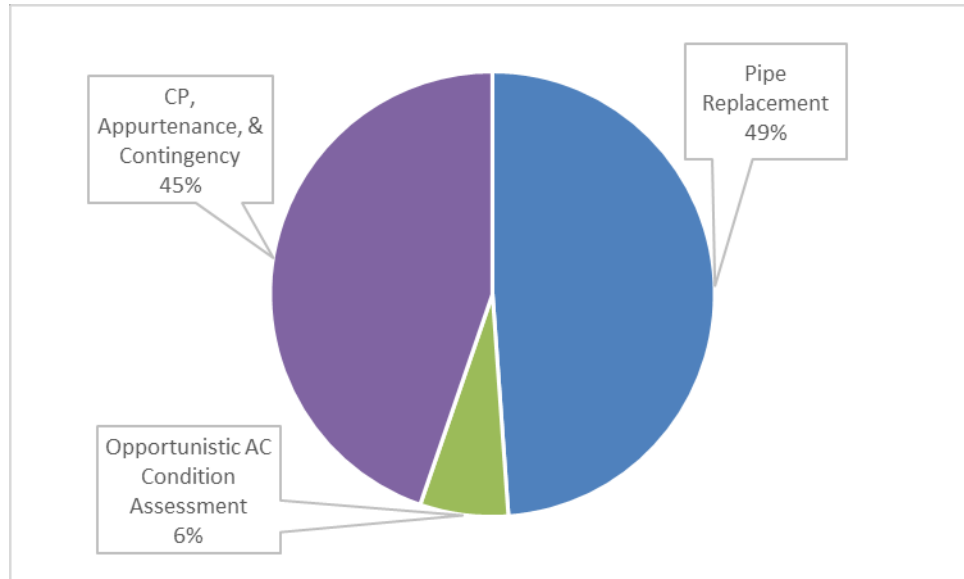


Figure 7-2. Benchmarking of District Performance & Investment Levels



Once a sustainable investment level was established, the next objective was to focus those investments so that ratepayers realize a greater return on their investment. Readily available data was evaluated¹¹ to identify and prioritize capital projects based on risk over the next ten years. This includes pipe replacement projects, condition assessment projects, and appurtenance and cathodic protection (CP) investments. These projects were reviewed with staff to incorporate staff input and identify and remove any projects where a current renewal project was already planned and budgeted. Figure 7-3 summarizes the recommended projects by investment type cost. A description of each investment type, and the projects identified are included in **Section 7.3**.

Figure 7-3. Summary by Investment Type by Cost



Based on the budgets developed, a list of anticipated CIP projects are summarized in Table 7-1. This includes an optional task for proactive condition assessment of large (14-inches or larger) and consequential pipelines. Currently, there are no documented breaks on these pipes or other data that would indicate a replacement project is warranted. However, failure of these large pipes can be much more consequential and should be managed proactively.

¹¹ Main, service, and valve failure data described in Section 2 was used along with readily available condition assessment (Echologics ePulse data and Energy Dispersive Spectroscopy (EDS) data) and cathodic protection reports.

Table 7-1. Summary of Recommended CIP Projects

#	Investment Type	Project Name	Estimated 10-yr Cost
1	Pipe Replacement	Edinburg & Cambridge	\$590,000
2	Pipe Replacement	1957 Asbestos Cement (AC) Pipe East of Glen Park	\$1,260,000
3	Pipe Replacement	Arcadia & Santa Fe	\$1,570,000
4	Condition Assessment	Opportunity AC Testing & Decision Making	\$450,000
5	Other	CP, Appurtenance, & Contingency	\$3,130,000
Total			\$7,000,000
Optional			
6	Condition Assessment	Proactive Large Diameter	\$2,500,000
Total			\$9,500,000

7.1. System Inventory, Performance, & Replacement Cost

7.1.1. System Inventory

The District's infrastructure database of record is the Geographic Information System (GIS). The District provided readily available GIS files in July of 2020. The dataset used as the basis of this report was "w_Transmission_Main_Export_Output" and "w_Main_Export_Output"¹². These layers were filtered to active, District owned and maintained distribution infrastructure¹³. This study also excludes the 54-inch transmission line that has shared ownership. Based on these filters, the District owns or maintains 168 miles of pipe. In general, the key asset attributes were well populated, however 16% of pipes were missing an installation year. To determine installation year, the following assumptions were made to update the working GIS database for analysis:

1. Use installation year field
2. If installation year is unknown, then use installation date field
3. If still unknown, then use the work order number (which typically includes the original install year) from the original construction project
4. If still unknown, then assume the average year by material (PVC = 1997; AC = 1972; Metallic = 1972).

¹² Service lines, hydrant laterals, valves, and other appurtenances were also provided and analyzed.

¹³ Infrastructure was filtered to include pipes with an OwnedBy field of "San Dieguito Water District" or "(blank)", Lifecycle of "ACT", and MaintainedBy of "San Dieguito Water District" or "(blank)". The SHAPELENGTH field is used for length.

7.1.2. Replacement Cost

When a main is replaced, the District typically replaces the connected services, valves, and other appurtenances. Therefore, the construction unit cost of infrastructure replacement includes the replacement of this infrastructure as well. The current replacement cost of the District's pipeline infrastructure¹⁴ is approximately \$490 million dollars. A summary of existing pipeline infrastructure and replacement costs are included in Table 7-2. The basis for this replacement cost estimate includes recent District and other utility bid costs and assumed soft costs for planning, design, legal, construction administration, and ownership administration. The weighted average replacement cost including soft costs is \$3 million per mile.

Table 7-2. Current Water Pipe Replacement Cost

Diameter (inches)	Total Construction Unit Cost (\$/mile)	Miles	Cost
6 or less	\$ 1,725,000	40.8	\$ 70,000,000
8	\$ 1,875,000	57.7	\$ 108,000,000
10	\$ 2,100,000	5.4	\$ 11,000,000
12	\$ 2,250,000	33.9	\$ 76,000,000
14	\$ 2,625,000	1.9	\$ 5,000,000
16	\$ 3,000,000	12.9	\$ 39,000,000
18	\$ 3,150,000	0.6	\$ 2,000,000
20	\$ 3,525,000	0.9	\$ 3,000,000
24	\$ 4,200,000	0.7	\$ 3,000,000
30	\$ 5,250,000	5.2	\$ 27,000,000
36	\$ 6,300,000	5.2	\$ 33,000,000
Subtotal		165	\$ 377,000,000
Soft Cost Type		Percentage	
Planning		3%	\$ 11,310,000
Design		10%	\$ 37,700,000
Legal		2%	\$ 7,540,000
Construction Administration		10%	\$ 37,700,000
Ownership Administration		5%	\$ 18,850,000
<i>Subtotal Soft Costs</i>		<i>30%</i>	<i>\$ 113,100,000</i>
Total Replacement Cost			\$ 490,100,000

¹⁴ Costs do not include inflation. The pipeline replacement cost includes both construction and soft costs for mains, services, and valves. The cost excludes pressure reducing stations, pump stations, tanks, and other facilities.

7.1.3. Mainline Performance

The District has documented 84 main breaks between 2003 and 2019 (17 years). These breaks were reviewed to identify and filter out records that did not correspond to a main break including duplicates, investigation but no leak observed, valve/service leaks, contractor hits, breaks on saddles, wash out events from major storms, and breaks other non-condition related breaks as determined by District staff. This filtering resulted in 23 total main break events that were used for benchmarking purposes. Two of these condition related main breaks have occurred on pipe that has since been replaced leaving 21 documented condition related main breaks on pipe that is currently in active service. A summary of this analysis is included in Table 7-3. The data and assumptions were reviewed with District staff to validate that the break records observed align with institutional knowledge. Where breaks were not associated to the pipe that broke, the break was associated to the nearest pipe based on the address of the break.

Table 7-3. Categorization of Main Breaks

Break Count	Description
84	Main Break Records (2003 to 2019)
7	Duplicate
7	Call but no leak on District Main
5	Leak on District Valve/Service
25	Hits (Contractor/Customer)
3	Saddle
1	Storm wash-out
13	Staff Identified Non-Condition Related Break
23	Main Breaks (Benchmarking)
165	Miles of Distribution & Transmission Mains
0.8	Break Rate
2	Condition Related Breaks on Pipes Since Replaced
21	Condition Related Breaks on Active Pipe

In the industry, system performance is often measured in terms of “break rate” which measures the annual number of main breaks per 100 miles of pipe operated. Since the District’s system is 168 miles and has experienced 23 main breaks between

2003 and 2019, the District's break rate is approximately 0.8 annual breaks per 100 miles. Recent research¹⁵ indicates that the average break rate in the region is 9.7 annual breaks per 100 miles. Therefore, the District's system is currently operating twelve times better than the regional average. Compared to other utilities in California where pipe materials and soil conditions tend to result in longer useful lives and the cost of water drives utilities to manage aging infrastructure more proactively, the District is within the top quartile of utilities in terms of break rate. In part, the District's good mainline pipe performance is likely due to good operational practices to minimize pressure surges and soil conditions that are particularly amenable to longer useful life in the prominent materials in the District's system. For example, asbestos cement (AC) pipe makes up 67.1% of the system by length. The predominant drivers for AC pipe deterioration in the US are cement leaching, salt-cracking, and ground movement. A more detailed description of cement leaching is included in Appendix B. Salt cracking occurs where salts migrate into the pipe wall through capillary and evaporation processes and then expand when hydrated. Figure 7-4 shows the San Antonio (on the left) and the District's service area (on the right) with salt concentration levels shown on a red (high salt content) to green (low salt content) scale. The District's AC pipe is exposed to much lower levels of salts and as a result, even though the average age is similar, the break rate in the District's system is roughly 20 times better than in San Antonio.

Figure 7-4. Potential for Salt Cracking

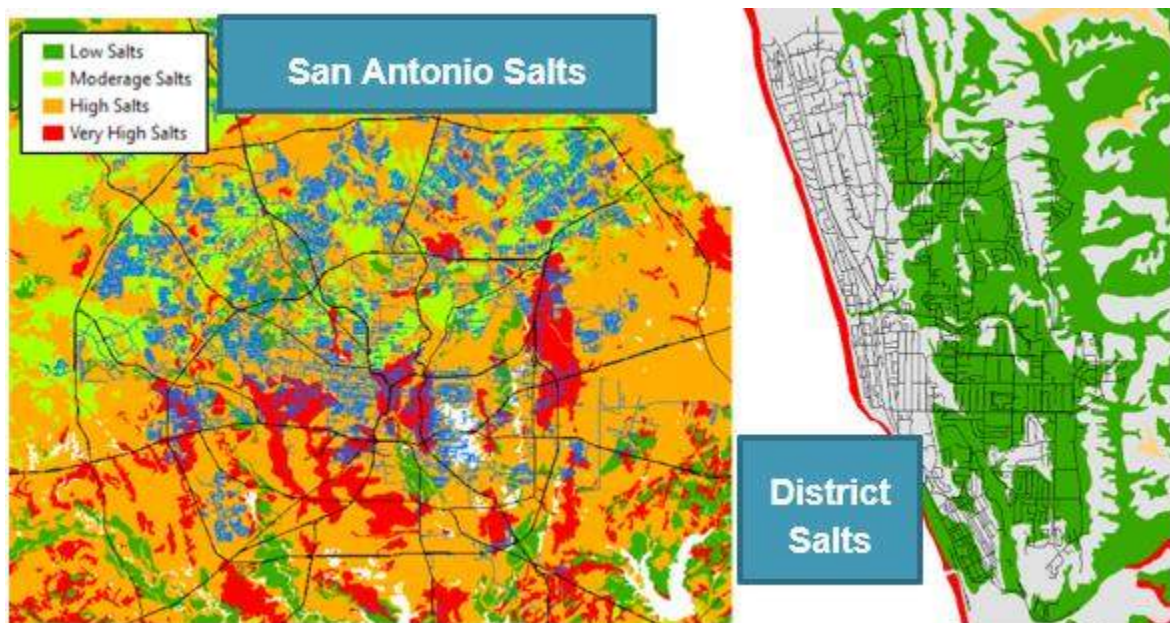
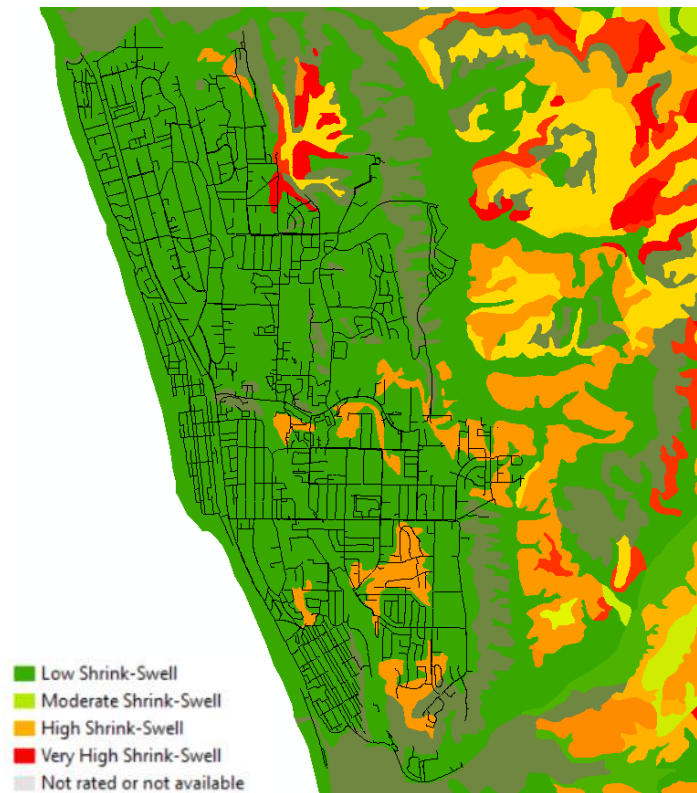


Figure 7-5 shows that District pipes are also installed in soils that have a relatively low linear extensibility. Linear extensibility describes the relationship between moisture content and the volume of soils. A higher linear extensibility means that the soil above the water table will expand and contract much more during seasonal variation in rain and the associated moisture content. This cyclical ground movement (i.e. shrink-swell potential) causes bending stresses that can accelerate crack growth and trigger breaks to occur sooner due to elevated stresses. In addition to shortening useful life, pipes exposed to elevated shrink-swell potential will typically break more often just before the first significant rain when soils dry, shrink, and provide less support for the pipe. In general, higher levels of shrink-swell potential will reduce the life of all pipe materials but it is particularly important for brittle materials such as AC pipe.

¹⁵ The average break rate in California and Nevada is 9.7 per Folkman's 2018 report titled Water Main Break Rates in the USA and Canada: A Comprehensive Study.

Figure 7-5. Potential for Shrink-Swell

Due to good operational practices to minimize pressure surges and soil conditions that are particularly amenable to the prominent materials in the District's system, the District's pipeline infrastructure would generally be expected to last longer than published industry useful life estimates. While the vast majority of the District's infrastructure is expected to have a long life, variables¹⁶ will cause some District pipes to deteriorate much faster than the average. In order to sustain good service levels, the District will need to make modest investments in condition assessment and replacement to identify, prioritize, and replace pipes in poor condition.

7.1.4. Valve Performance

The primary purpose of valves is to control or stop the flow of water through pipes. The ability of an isolation valve to stop the flow of water in a pipe is particularly important in limiting the impact or consequence of failure (CoF) during planned and unplanned shutdowns. Valves are an important, but often overlooked, asset within the distribution system because they typically fail in the open position and may not impact service levels for years, until they are needed. However, for pipe of similar diameter and material, research¹⁷ has shown that the cost of pipe failure can vary by more than three orders of magnitude and is most influenced by the time required to find and close functional valves.

The District provided a report of historic valve operation records between 2014 and March 2020. Crews noted when valves were inoperable or needed repair in the "Status" field. Additionally, a search of crew comments was performed to identify leaking valves or valves that don't shut down water. This resulted in a total of 275 documented events where valve

¹⁶ Variables that may cause accelerated deterioration include manufacturing quality, construction quality, internal pressure, external loading, and soil characteristics such as corrosivity and shrink-swell potential. These variables have been observed to varying degrees at similar utilities. District specific variables are difficult to quantify at this time due to the lack of main breaks in the system.

¹⁷ Based on the 2007 Water Research Foundation Study *Analysis of Total Cost of Large Diameter Pipe Failures*.

replacement could add value. It is important to note that the CoF for valves varies dramatically from valve to valve. Therefore, it is anticipated that a budget will be identified for proactive replacement of critical failed valves as well as incorporating the value added of replacing non-critical valves when determined where to make pipeline replacement investments where valves are replaced simultaneously.

7.1.5. Service Performance

The District has documented 444 service main breaks between 2002 and 2020 (19 years). These breaks were reviewed to identify and filter out records that did not correspond to a main break including duplicates and issues on the customer side of the meter. This resulted in 432 total service break events used for benchmarking. Service break records were also reviewed and categorized to distinguish condition related breaks by excluding breaks due to contractor hits. This resulted in a total of 346 service breaks. A summary of this analysis is included in Table 7-4. The data and assumptions were reviewed with District staff to validate that the break records observed align with institutional knowledge. Where breaks were not associated to the pipe that broke, the break was associated to the nearest pipe based on the address of the break.

Table 7-4. Categorization of Service Breaks

Break Count	Description
444	Service Breaks (2002 to 2020)
12	Customer Side or Duplicates
432	Service Breaks (Benchmarking)
24	Service Breaks Per Year
12,009	Services
2	Annual Service Breaks per 1000 Services
86	Hits (Contractor/Customer)
346	Condition Related Service Breaks
18.2	Service Breaks Per Year

In California, the average non-mainline break rate is approximately 5.6 annual breaks per year per 1,000 services owned. District reports 12,009 services. With approximately 24 service breaks per year, the District has a service break rate of 2.0 or about three times better than the average in California. Since services are performing well and it is less expensive and disruptive to replace mains and services simultaneously as opposed to in separate projects, this report will focus on capital improvements that replace pipes, valves, and services simultaneously. However, in the future if areas of the system are observed to have many service breaks and no main breaks, it may be appropriate to have a proactive service replacement project in that area.

7.1.6. Cathodic Protection System Performance

The District has followed industry best practice performing annual CP surveying on their infrastructure. The recommendations from the latest CP Report (2019) are appropriate which include replacement of impressed current and sacrificial anodes, repairing damaged CTS leads, evaluating the cause of inadequate polarization between rectifiers #7 and #8 on the 36-inch transmission line, CTS wire testing within the Encinitas Ranch Reservoir CTSs, and continued annual surveys of cathodic protection systems. It is recommended that the District also investigate:

1. the lack of polarization at CTSs 1 and 2 on the 30-inch line,
2. the net current flow from foreign cathodic protection being in excess of 17 amps which may be causing stray current. A close interval survey should be performed to evaluate the presence of stray current, and
3. evaluate whether instant off pipe-to-soil potential measurement would be cost effective to collect. This would enable the District to truly comply with the NACE SP-0169 criteria.

7.2. Budgeting for Aging Infrastructure

Over time, pipeline infrastructure will deteriorate, break more often, and ultimately will need to be replaced. This section establishes prudent, transparent, and justifiable CIP budgets to address aging water pipeline infrastructure. The CIP budget will enable the District to sustain desired services levels, extend the life of existing infrastructure, and mitigate the risk of large and unplanned rate increases due to aging pipeline infrastructure.

7.2.1. Age-Based Pipeline Renewal Budget

An age-based pipeline renewal budget was developed using unit costs established in **Section 7.1**, District infrastructure installation years, and published useful life estimates from the America Water Works Association (AWWA) report titled Buried No Longer: Confronting America’s Water Infrastructure Challenge as summarized in Table 7-5.

Table 7-5. Age Based Useful Life

Material	Useful Life (Years)	Miles
Ductile Iron Pipe (DIP)	85	1
Steel (STL)	95	10
Plastic	70	40
AC	90	111
Other Metallic	75	2
Unknown	80	1

Based on these assumptions, 79% of the system will reach the end of its useful life over the next 50 years. Based on the unit cost assumption in Section 2.1, the replacement cost including soft costs and excluding inflation would be \$388 million dollars or roughly \$7.8 million dollars per year over the next 50 years.

7.2.2. Performance-Based Pipeline Renewal Budget

Figure 7-6 illustrates that age alone is a poor indicator of pipe condition and remaining useful life.

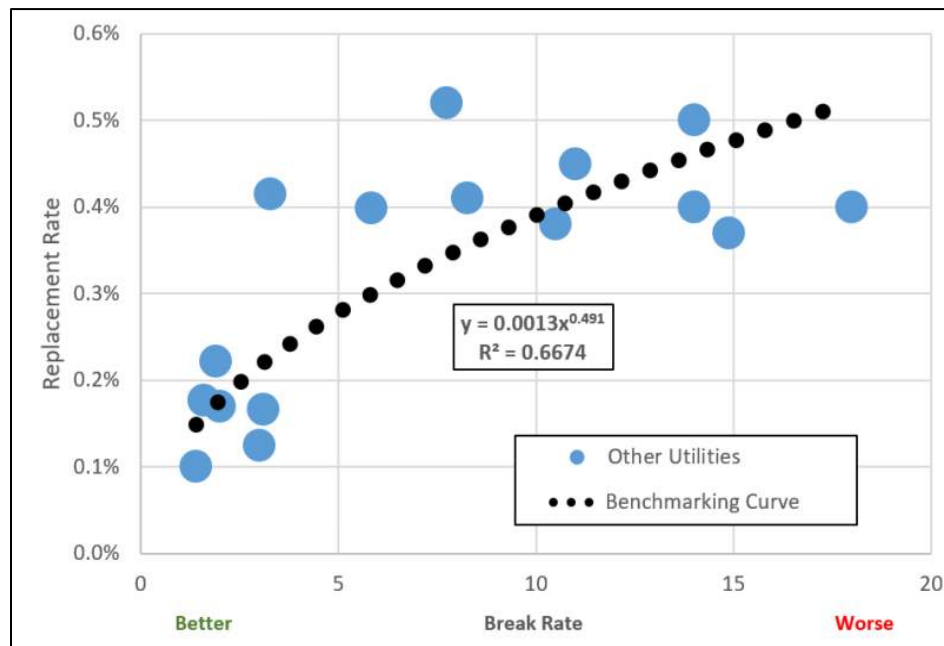
Figure 7-6. Age Alone is a Poor Indicator of Pipe Condition and Remaining Useful Life



Institutional knowledge and industry expertise suggest that the District's infrastructure will last significantly longer than age-based estimates.

In an effort to establish prudent, transparent, and data driven investment levels that maximize the life of existing infrastructure, a benchmarking effort was initiated to compare District performance and investment levels to other similar utilities. Utilities were benchmarked based on break rate (i.e., annual breaks per 100 miles of pipe owned) and replacement rate measured as the percentage of the system replaced annually. Figure 7-7, benchmarks similar utilities where the blue circles represent these utilities:

- City of Carlsbad
- Vista Irrigation District
- Rainbow Municipal Water District
- Sweetwater Authority
- Padre Dam Municipal Water District
- Helix Water District
- City of Buena Park
- City of Vernon
- Los Angeles DWP
- City of Long Beach
- San Juan Water District
- Contra Costa Water District
- East Bay MWD
- City of Phoenix
- Denver Water

Figure 7-7. Benchmarking of District Performance & Investment Levels


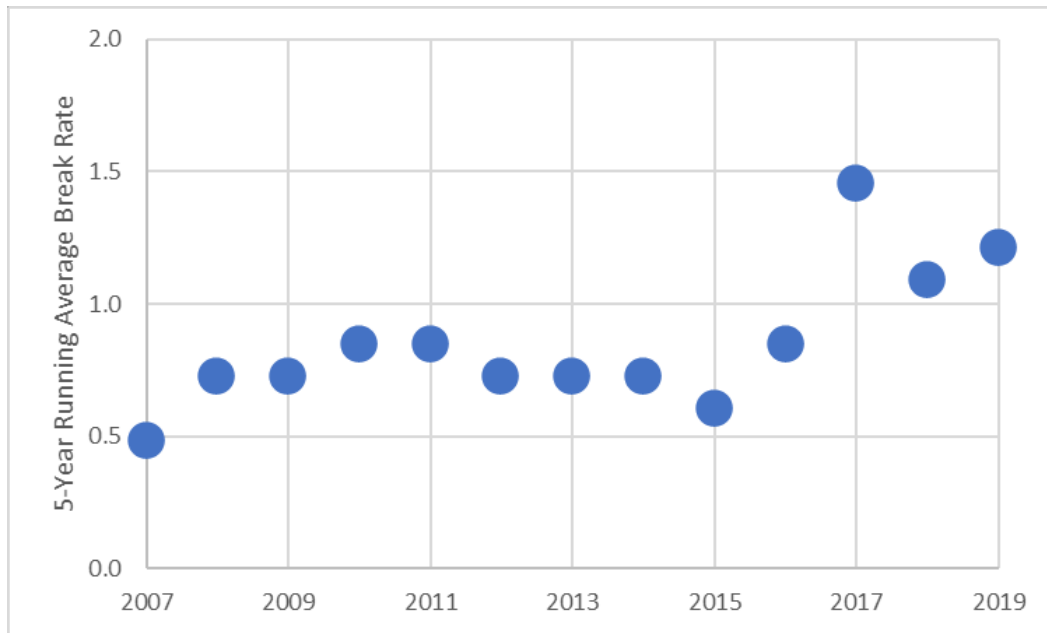
Each community must find the appropriate balance between service levels and near-term cost for their community. In general, systems that are performing well do not require significant investment levels. However, as pipes deteriorate and break more often, increased investment in pipeline replacement is warranted. The black circles in Figure 7-7 and Equation 1 below quantify this relationship for the utilities that were benchmarked.

Equation 1: Replacement Rate = 0.0013 * Break Rate ^ 0.491

Figure 7-8 summarizes the District's historic break rates using a 5-year running average. Over the past 15 years, District break rates have increased as infrastructure continues to age and deteriorate. Recent break rates are approaching 1.2 annual breaks per 100 miles. Applying this break rate to Equation 1 and the total system replacement cost of \$490 million dollars, it is estimated that the District should be investing approximately \$700,000 dollars per year including soft costs but excluding inflation in the distribution and transmission system. By moving from an age-based to a performance-based program, the District will save approximately \$7 million dollars per year¹⁸. Note, because the recommended investment level is significantly higher than historic budgets, it may be necessary to ramp up spending to that level over the course of five to ten years.

¹⁸ Based on the age-based renewal budget estimate in Section 3.1.

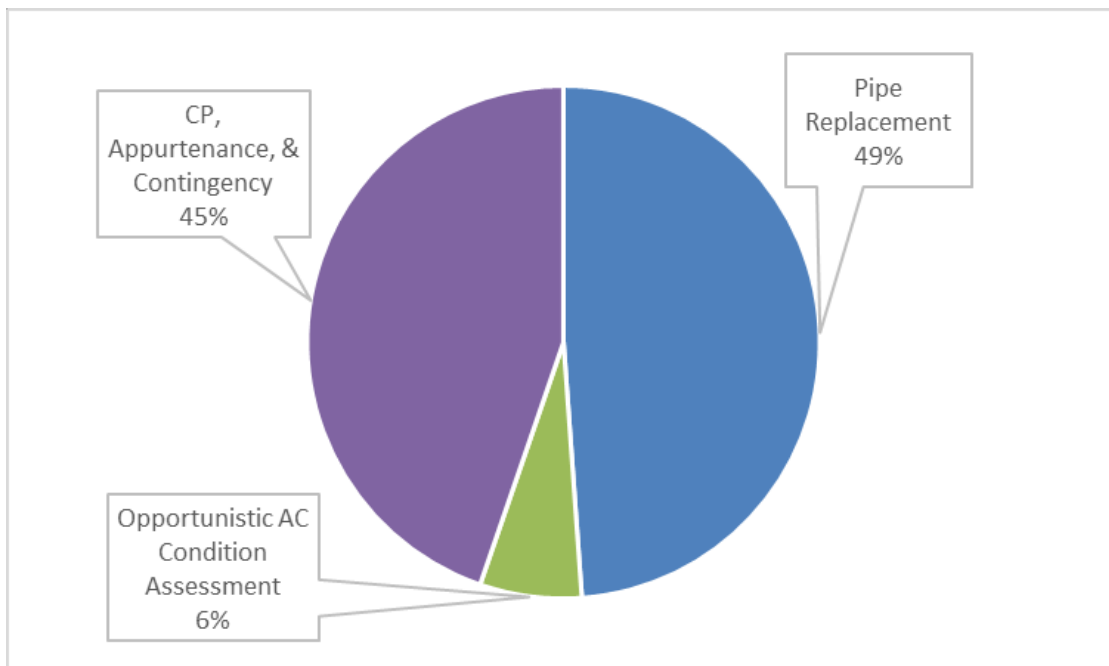
Figure 7-8. District Break Rate History



7.3. Recommended Distribution System Projects

Once a sustainable investment level was established, the next objective was to focus those investments so that ratepayers realize a better return on their investment. Figure 7-9 summarizes the recommended projects by investment type. A description of each investment type, and the projects identified are included in this section.

Figure 7-9. Summary by Investment Type



7.3.1. Risk Assessment

While most District pipeline infrastructure is expected to last well beyond the average published useful life estimates from AWWA, the useful life of particular pipes can vary significantly depending on manufacturing quality, installation quality, variations in deterioration factors (e.g., soil corrosivity, water corrosivity, presence of ground water), and variations in pipe stresses (e.g., pressure, ground movement, external loading). A system-wide risk assessment was performed with District staff based on this data and institutional knowledge. In the past, staff have been concerned with losing service to the hospital (the District's most critical customer) but improvements have been made to add looping which mitigates this risk. Staff were also concerned with pipe near Neptune Avenue because it is near the bluff and a failure could be catastrophic. Review of main break data did not show any documented failures in this area and therefore renewal is not warranted. This may be an appropriate area to focus medium term condition assessment activities recommended in **Section 7.3.3** and **Section 7.3.4**.

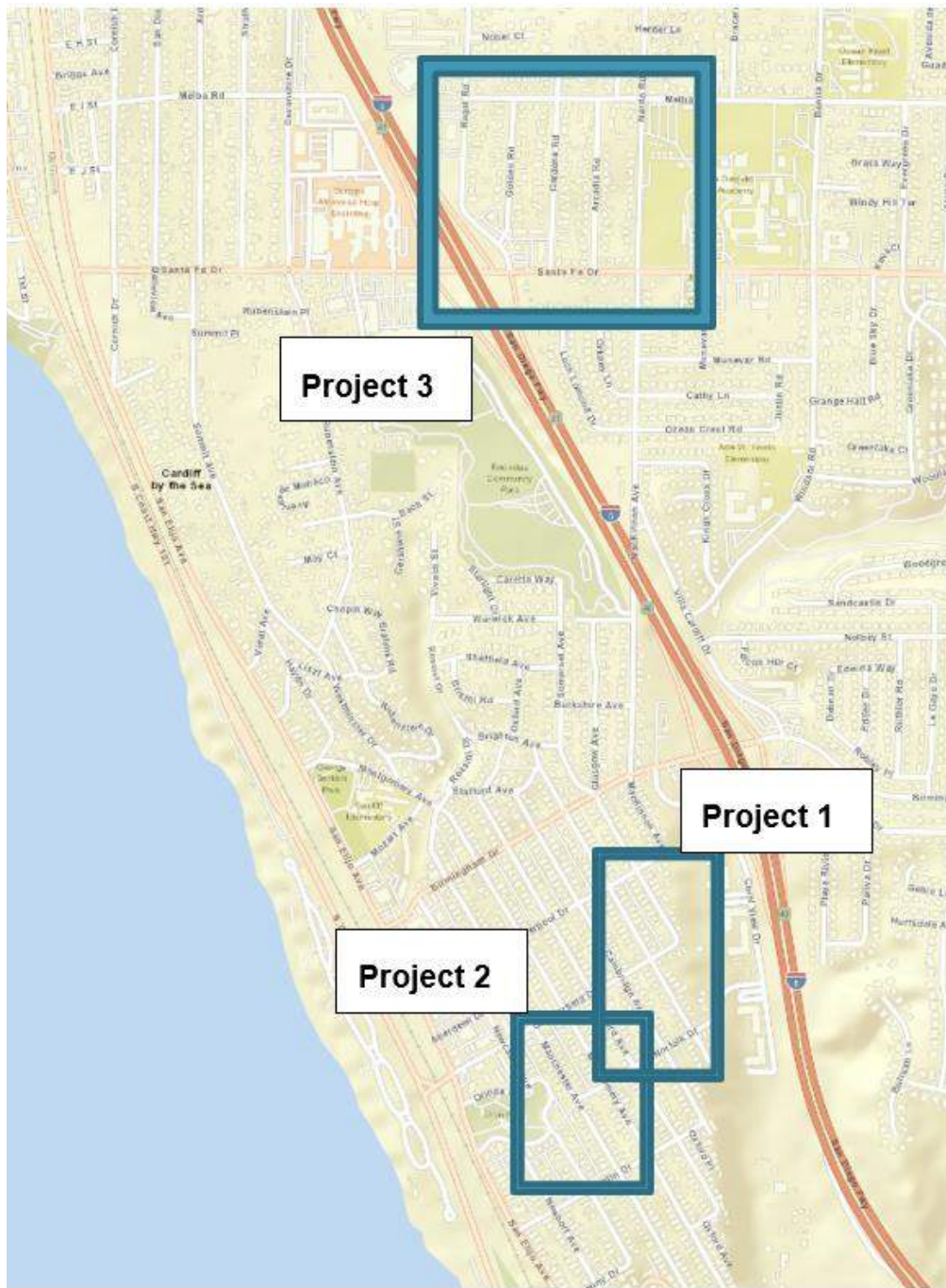
Three areas were identified through analysis of the data and verified by staff as being high risk and potentially in need of a near term renewal project. While these three areas represent less than 1% of the system by length, they include 48% of all documented condition related main breaks and represent an elevated risk of failure. Review of the location of the remaining condition related main breaks showed that they were scattered throughout the system, lower risk, and do not warrant replacement at this time. Therefore, additional research and risk assessment was performed in these three areas as described below.

7.3.2. Pipeline Replacement

Readily available data was evaluated¹⁹ to identify potential near-term pipe replacement candidates. These projects were reviewed with staff to identify and remove any projects where a current renewal project was already planned and budgeted. The result was the identification of three near-term replacement projects shown in Figure 7-10. The basis for each project is described in more detail below. The total cost of these projects is expected to be approximately \$3.42 million dollars.

¹⁹ Main, service, and valve failure data described in Section 2 was used along with readily available condition assessment (Echologics ePulse data and Energy Dispersive Spectroscopy (EDS) data). A description of how this data was used to quantify LoF Ratings and project extents is included in Appendix C.

Figure 7-10. Recommended Near Term Replacement Projects



7.3.2.1. Project 1 – Alley between Edinburg and Cambridge from Liverpool past Norfolk

The first project identified includes approximately 1,390' of 6-inch AC pipe shown in Figure 7-11. In the map, pipes are symbolized as colored lines on a red to green scale where red pipes are new pipes and dark green pipes are older pipes. This area has six condition related mainline breaks (red stars) and five service line breaks (purple stars). Each break shown in the map includes the date of the break. The mainline has broken as recently as April 2017 and the services have broken as recently as February 2020. The project extents also include one mainline isolation valve that needs to be replaced (green hour glass) near the intersection of Edinburg and Liverpool where there the proposed project extents begin. The project would continue southwest to the pipe in the alley between Edinburg and Cambridge and end where the AC pipe turns into PVC pipe near Norfolk Drive. Note, the pipe south of Norfolk Drive has already been replaced. Based on the unit costs in **Section 7.1**, the estimated cost of this project is summarized in Table 7-6. The exact extents of the project should be finalized during design of this pipe replacement.

Figure 7-11. Map of Project 1 – Edinburg & Cambridge

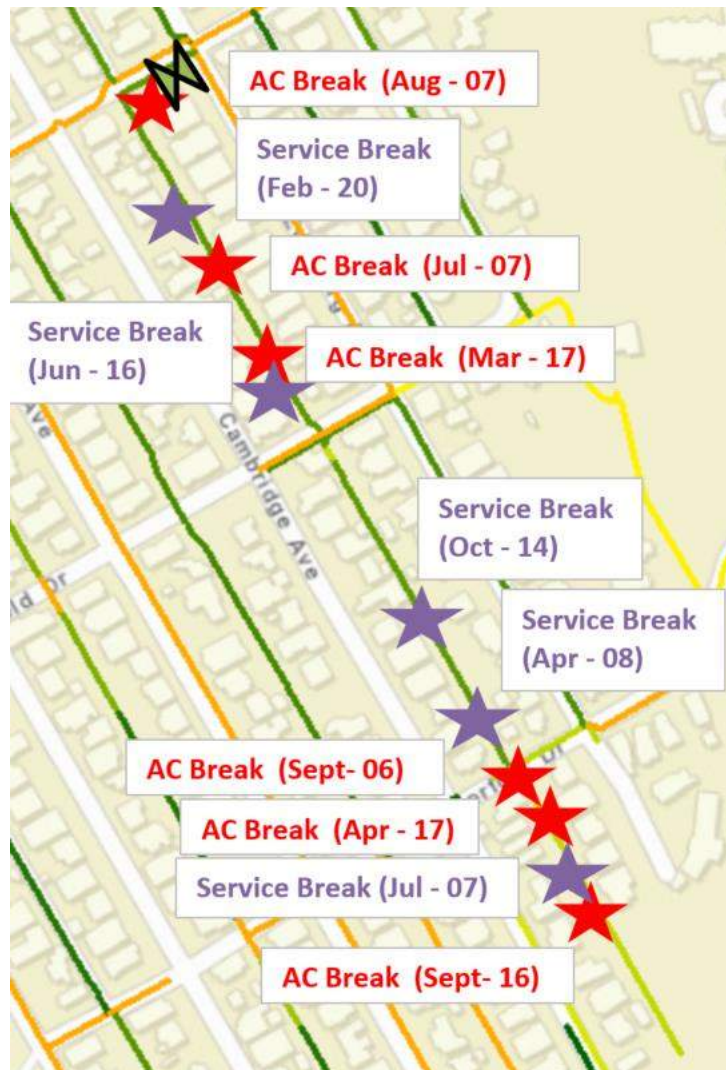


Table 7-6. Opinion of Cost for Project 1 – Edinburg & Cambridge

Diameter (inches)	Total Construction Unit Cost (\$/mile)	Miles	Cost
6 or less	\$ 1,725,000	0.26	\$460,000
Soft Costs		30%	\$130,000
Total Replacement Cost			\$590,000

7.3.2.2. Project 2 – 1957 AC Pipe East of Glen Park

Project 2 includes approximately 2,800' of AC pipe installed in 1957 bounded by Chesterfield, Newcastle, Dublin, and Oxford and is shown in Figure 7-12. In the map, pipes are symbolized as colored lines on a red to green scale where red pipes are new pipes and dark green pipes are older pipes. This area has six condition related mainline breaks (red stars), three breaks on the mainline saddle (black stars), and two service line breaks (purple stars). Each break shown in the map includes the date of the break. The mainline has broken as recently as August 2017 and the services have broken as recently as March of 2004. The project also includes two mainline isolation valve that needs to be replaced (green hour glasses) in the alley between Montgomery and Oxford and the intersection of Norfolk. An EDS sample was taken near this project on Oxford (blue circle), however this pipe is of a more recent vintage 1984 and the testing showed the pipe was in good condition. This helps to verify that the current issue in this area is limited to the older AC pipe. The proposed project includes the mains in:

1. Alley between Montgomery and Oxford from Chesterfield to Dublin.
2. Alley between Montgomery and Manchester from Chesterfield to Norfolk.
3. Alley between Newcastle and Manchester from Glen Park to Norfolk.
4. Optional: the alley between Newcastle and Manchester from Glen Park to Chesterfield (note, this pipe doesn't have any documented failures but is the same vintage and area as the other pipe. For this report, this pipe is not included in Project 2)

Based on the unit costs in **Section 7.1**, the estimated cost of this project is summarized in Table 7-7. The exact extents of the project should be finalized during design of these pipe replacements.

Figure 7-12. Map of Project 1 – 1957 AC Pipe East of Glen Park

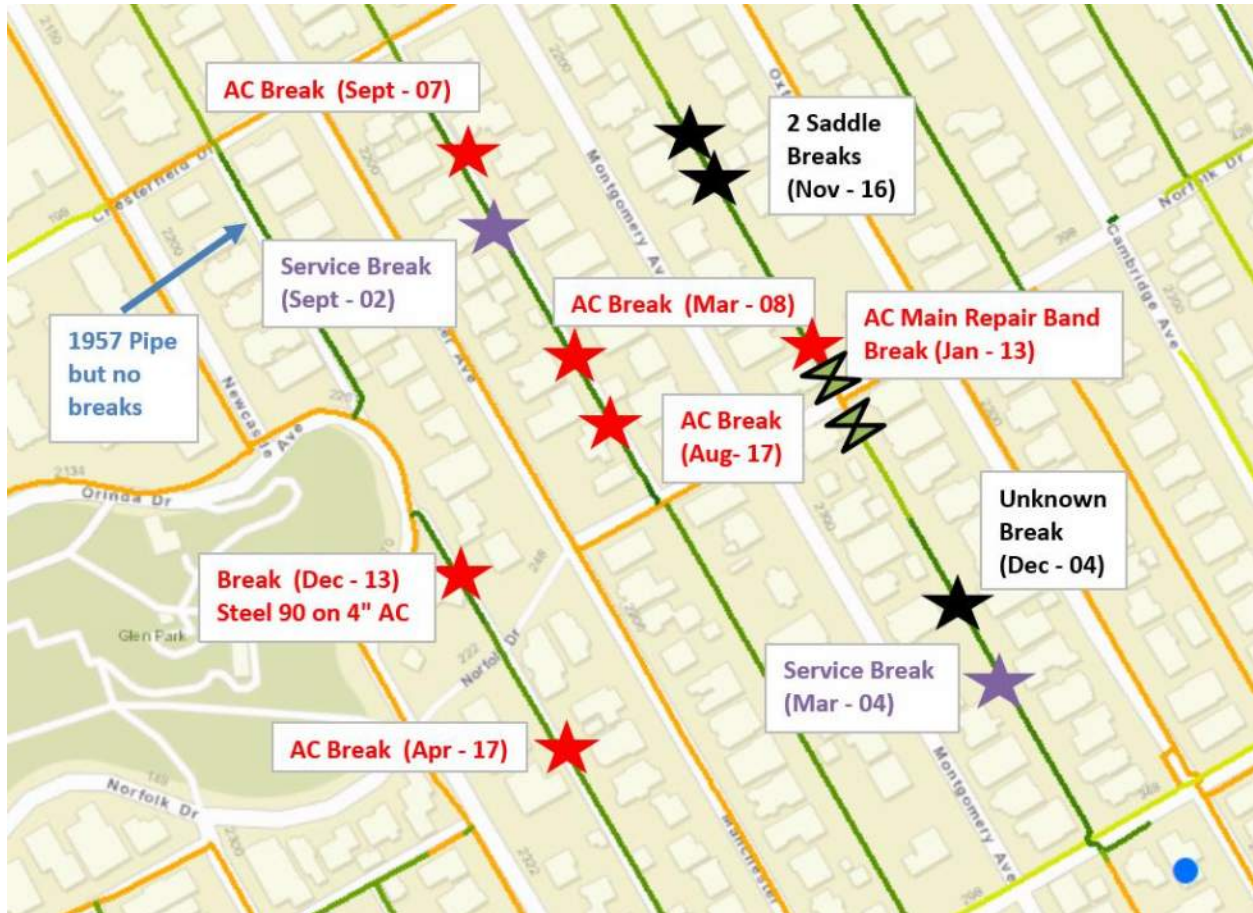


Table 7-7. Opinion of Cost for Project 2 – 1957 AC Pipe East of Glen Park

Diameter (inches)	Total Construction Unit Cost (\$/mile)	Miles	Cost
6 or less	\$ 1,725,000	0.41	\$710,000
12	\$ 2,250,000	0.12	\$260,000
Soft Costs		30%	\$290,000
Total Replacement Cost			\$1,260,000

7.3.2.3. Project 3 – Arcadia

Project 3 includes approximately 1,300' of 6-inch AC pipe in Arcadia between Santa Fe and Melba (red line) shown in Figure 7-13, 1,300' of 6-inch AC pipe in Melba and 840' of 12-inch AC pipe in Santa Fe. This area has two condition related mainline breaks (red stars) one of which was large, one saddle break (black star), and one contractor mainline break (orange star). Given the number of mainline breaks, it is possible that the fragile pipe contributed to the contractor hit. An EDS condition assessment was conducted on Arcadia near Melba. This pipe was one of only two pipes sampled that tested as having a high likelihood of failure per the assessment guidelines identified in Appendix C. The pipe is near the end of its useful life and should be replaced.

The pipe on Arcadia also has an inoperable mainline valve near the intersection of Santa Fe. As a result, the shutdown will likely require shutting down the 12-inch AC pipe in Santa Fe. That pipeline has a number of service breaks as well and is of the same era as the pipe on Arcadia. In addition, Echologics ePulse testing shows that this pipe has only about 10 more years of life than the pipe on Arcadia. Therefore, while mobilized for replacement of the Arcadia line, it is recommended that the District consider replacing the pipe on Santa Fe from Nardo to the tee adjacent to the Pressure Reducing Station. It is likely that once the weakest link is fixed (pipe on Arcadia), breaks may migrate to the next weakest link on Santa Fe or Melba. Figure 7-14 shows the extents and calculated remaining useful life from Echologics in the area. The segment number can be used to relate the condition assessment data in the table to the map.

The AC pipe on Melba between Nardo and Regal also tested in poor condition based on Echologics ePulse testing. That pipeline also has numerous service line breaks. It is recommended that all three pipes be replaced. The other pipes in this neighborhood have tested to be in poor condition based on Echologics ePulse but have not been verified as requiring a replacement based on infrastructure performance. Therefore, it is recommended that the District delay replacing these pipes. Based on the unit costs in **Section 7.1**, the estimated cost of this project is summarized in Table 7-8. The exact extents of the project should be finalized during design of these pipe replacements.

Figure 7-13. Map of Project 3 – Arcadia Mainline

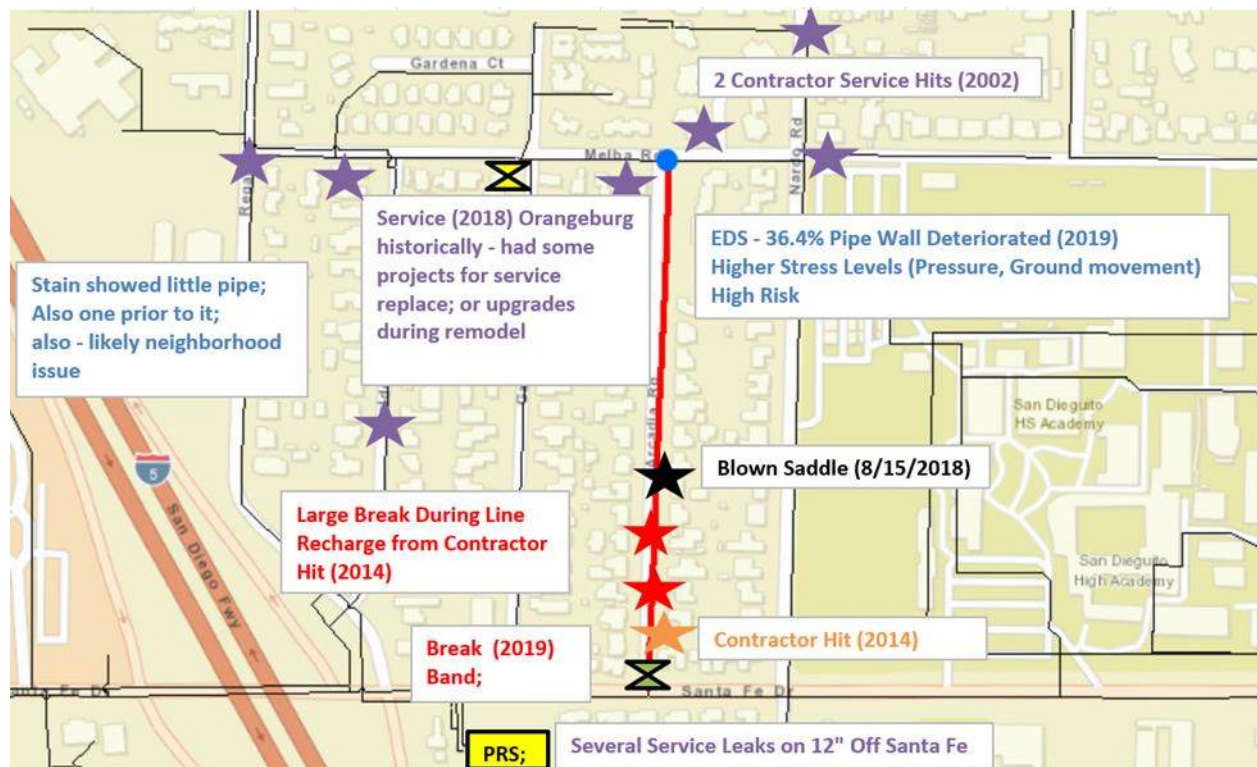
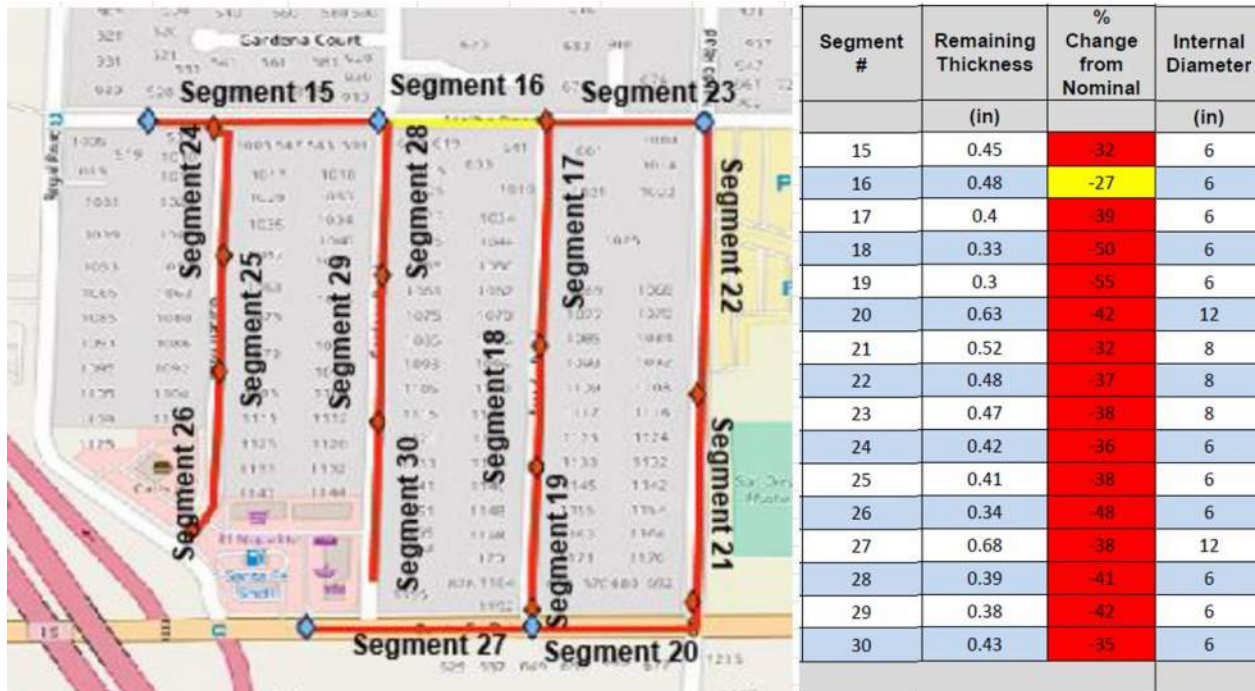


Figure 7-14. Map of Project 3 – Arcadia Mainline Condition Assessment

Table 7-8. Opinion of Cost for Project 3 – Arcadia Mainline

Diameter (inches)	Total Construction Unit Cost (\$/mile)	Miles	Cost
6 or less	\$ 1,725,000	0.50	\$860,000
12	\$ 2,250,000	0.16	\$350,000
Soft Costs		30%	\$360,000
Total Replacement Cost			\$1,570,000

7.3.3. Opportunistic AC Condition Assessment

Direct condition assessment of in-service AC pipe is expensive and disruptive to the community. However, when an AC pipe is exposed (e.g., during break repair, new tap installation, pipe renewal, and appurtenance renewal), it provides a unique opportunity to cost effectively gather condition assessment data that can be helpful in making more effective pipe management decisions. In order to cost effectively manage aging AC infrastructure, it is recommended that the District re-establish the Opportunistic AC Condition Assessment Program. Assuming roughly 20 samples are collected tested and analyzed per year, it is estimated that this program will cost roughly \$45,000 per year, including \$30,000 per year for laboratory testing and \$15,000 per year in consulting support data interpretation and decision making.

7.3.4. Proactive Large Diameter Condition Assessment

Currently, there are no documented breaks on pipes 14-inches or larger or other data that would indicate a replacement project is warranted. However, failure of these large pipes can be much more consequential and should be managed proactively. A targeted pipeline condition assessment program will support cost effective system management and risk mitigation by:

- Extending the life of some pipes found to be in good condition,
- preventing unnecessary breaks in other pipes found to be in poor condition,
- identifying the most cost-effective renewal technology and project extents, and
- increasing confidence in decision making.

The District owns 12 miles of large metallic pipe and 7.6 miles of large AC pipe. Appendix B describes how AC pipe deteriorates and Appendix D describes how metallic pipe corrodes. For budgeting purposes, it is assumed that pipes 14-inches and larger will require high-resolution, proactive condition assessment once every 40-years. A planning level estimate of the cost to perform high-resolution condition assessment of this infrastructure is included in Table 7-9. These costs include \$230,000 over the 10-year planning period to develop and annually update a tactical condition assessment plan to determine specific technologies and pipes to assess. These costs do not include inflation. A description of the methods and assumptions for metallic and AC pipes are included in Appendix E and Appendix F respectively. The unit costs used in this section are based on recent similar work at other utilities and is intended to be used for systematic planning and budgeting. Project specific costs will vary based on the unique operating context of each pipe.

Since no documented failures have occurred on this, this investment is included as an optional project.

Table 7-9. Optional Condition Assessment Projects

Material	Miles of Pipe 14" or Larger	Unit Cost (\$/mile)	Total Cost	Annualized Cost
AC	7.6	\$90,000	\$684,000	\$17,000
Metallic	12.0	\$700,000	\$8,400,000	\$210,000
Tactical 10-yr Condition Assessment Plan				\$23,000
Total	23.3			\$250,000

7.3.5. Cathodic Protection, Appurtenances, and Contingency

Historically, the District has invested most of the capital funds in cathodic protection, valve replacements, and other appurtenances. In addition, it would be prudent to include a contingency to address at least one significant improvement that emerges over the next ten years. Based on the investment level identified in **Section 7.2**, this leaves approximately \$360,000 per year to invest in cathodic protection, valves replacement, appurtenance renewal, and contingency which is appropriate based on historic expenditure levels.

8. Capital Improvement Recommendations

This section presents the Capital Improvement Program (CIP) recommended based on the hydraulic model analysis, desktop analysis, and asset management study.

8.1. Capital Improvement Program

The proposed Capital Improvement Program (CIP) includes system improvements developed based on the hydraulic evaluation and the asset management study, as shown in Figure 8-1 and summarized in Table 8-1. These CIP projects were developed in consultation with District staff and were prioritized and phased into 5-year (2022-2027) CIP and 10-year (2028-2032) CIP. Details of the CIP development are discussed below.

8.1.1. Capacity-Based Pipeline Improvements

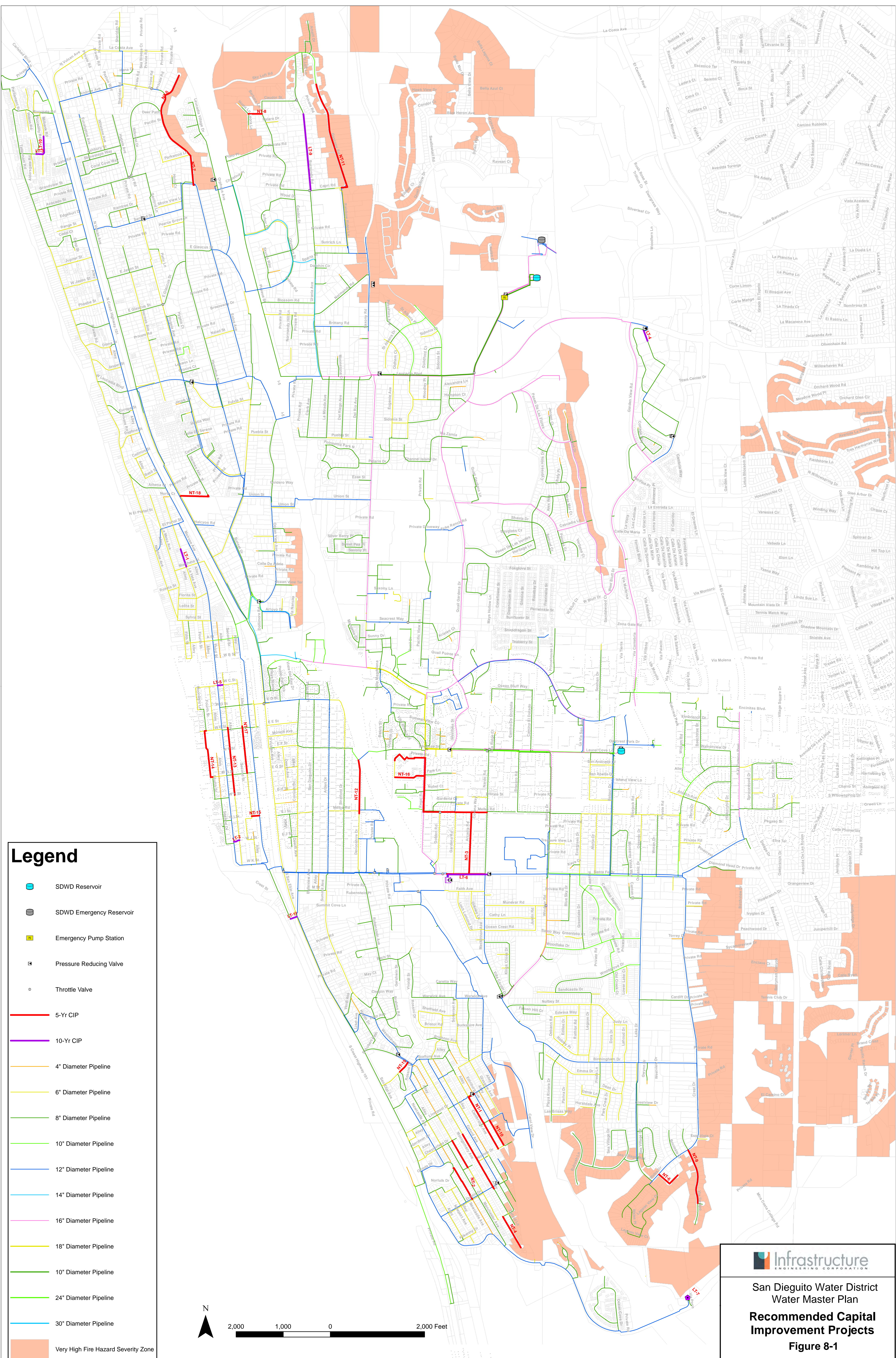
The District's water system was analyzed under various demand scenarios and evaluated against the recommended design criteria to identify system deficiencies for the existing and 2040 demand conditions. Model results indicated that a few model nodes do not meet the recommended minimum pressure and maximum pressure criteria under Average Day Demand (ADD), Maximum Day Demand (MDD), and Peak Hour Demand (PHD) conditions mostly due to the geography of the study area or location near reservoirs, closed operational valves or on transmission lines. As discussed in **Section 6**, there are approximately 230 junctions not meeting the pressure and velocity criteria under existing MDD + FF condition. Seventy-three (73) of the deficient junctions are unable to sustain the required fire flows at a minimum residual pressure of 20 psi. There are approximately 249 junctions not meeting the pressure and velocity criteria under 2040 MDD + FF condition. Seventy-six (76) of the deficient junctions are unable to sustain the required fire flows at a minimum residual pressure of 20 psi.

Deficient hydrants not within the VHFHSZ on dead-end pipes that can provide at least 500 gpm of fire flow are not recommended for improvements based on a cost versus benefit approach. Deficient hydrants within the VHFHSZ were further evaluated with required fire flow out of two consecutive hydrants to develop the capacity-based pipeline improvements needed to mitigate the pressure and pipeline velocity deficiencies under MDD + FF condition.




















Model results indicate deficient hydrants near Caudor St and Plato Dr. The District is working on installing a pressure reducing station (PRS) near the intersection of Caudor St and Burgundy Rd allowing water flow from Zone 409 to Zone 345. With the proposed PRS, no pipeline improvement is needed on the 8-inch line in Caudor St north of Capri Rd. Since this is an on-going improvement project, it is not included as a CIP project in the 2022 WMP. Detail of each proposed improvement is provided in the additional note section of Table 8-1.

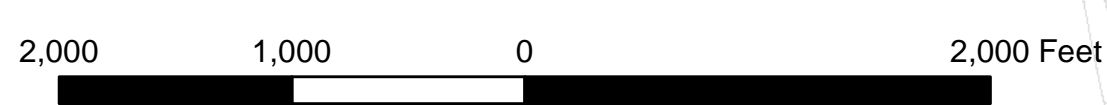
8.1.2. Condition-Based Pipeline Improvements

In addition, an asset management study was performed on the District's existing facilities, and six condition-based projects were identified. Details of the asset management study were discussed in **Section 7**. The pipeline replacement projects identified in **Section 7** are recommended to replace in kind. However, since the District's minimum size requirement for new pipelines is 8 inches in diameter, replacement of the 6-inch lines is adjusted to 8-inch lines. In addition, a pipe segment of the proposed condition-based Project 2 is also proposed as a capacity-based improvement project "Alley/Montgomery". Therefore, this pipe segment is recommended to be upsized instead of replaced, and the associated capital costs are accounted for in the "Alley/Montgomery" project. A small portion of the 6-inch line in Melba Rd that was proposed as part of the condition-based Project 3 is also proposed as part the capacity-based project "Regal Road". Therefore, these pipe segments are recommended be upsized instead of replaced, and the associated capital costs are accounted for in the Regal Road project.



Legend

-  SDWD Reservoir
-  SDWD Emergency Reservoir
-  Emergency Pump Station
-  Pressure Reducing Valve
-  Throttle Valve
-  5-Yr CIP
-  10-Yr CIP
-  4" Diameter Pipeline
-  6" Diameter Pipeline
-  8" Diameter Pipeline
-  10" Diameter Pipeline
-  12" Diameter Pipeline
-  14" Diameter Pipeline
-  16" Diameter Pipeline
-  18" Diameter Pipeline
-  10" Diameter Pipeline
-  24" Diameter Pipeline
-  30" Diameter Pipeline
-  Very High Fire Hazard Severity Zone



San Diego Water District
 Water Master Plan
**Recommended Capital
 Improvement Projects**
 Figure 8-1

Table 8-1. Proposed Capital Improvements

Priority	Type	Project #	Project Name	Note	Criteria Violated at Required Fire Flow	within VHFHSZ	Fire Flow (gpm)		Percent Available	Existing Diameter (in.)	Recommended Pipe Length per Diameter (feet)					Length (miles)	Phase	Additional Notes	
							Available	Required			8	10	12	16	18				Total
1	Condition-based	NT-1	Condition-based Project 1	Alley between Edinburg and Cambridge from Liverpool past Norfolk						6	1,409					1,409	0.3	2022-2027	See Section 7.3.2.1 for Detail
1	Condition-based	NT-2	Condition-based Project 2	1957 AC Pipe East of Glen Park						6 and 12	1,487		780			2,267	0.4	2022-2027	See Section 7.3.2.2 for Detail
1	Condition-based	NT-3	Condition-based Project 3	Arcadia						6 and 12	2,400		840			3,240	0.6	2022-2027	See Section 7.3.2.3 for Detail
1	Capacity-based	NT-4	Alley/Montgomery	Upsized existing pipe(s)	Negative Pressure	Yes	1,053	2,500	42%	4 and 6	1,273					1,273	0.2	2022-2027	upsized the 4-inch line in Alley between Norfolk Dr and Dublin Dr to 8-inch line; upsized the 6-inch line in Montgomery Ave southeast of Kelkenny Dr to 8-inch line
1	Capacity-based	NT-5	Andrew/Leucadia Scenic	Upsized existing pipe(s)	Negative Pressure	Yes	1,200	2,500	48%	8		978				978	0.2	2022-2027	upsized the 8-inch line in Andrew Ave and Leucadia Scenic Ct north of Deer Path to 10-inch line
1	Capacity-based	NT-6	Avocet Ct	Upsized existing pipe(s)	Negative Pressure	Yes	1,366	2,500	55%	6			308			308	< 0.1	2022-2027	upsized the 6-inch line segment in Avocet Ct between Wales Dr and the first hydrant to 12-inch line
1	Capacity-based	NT-7	Eolus Ave	Upsized existing pipe(s)	Negative Pressure	Yes	1,526	2,500	61%	2 and 6	664	1,069				1,733	0.3	2022-2027	upsized the 2-inch and 6-inch line in Eolus Ave between Hymettus Ave and Parkwood Ln to 8-inch line; upsized the 6-inch line in Eolus Ave between Parkwood Ln and Deer Path to 10-inch line
1	Capacity-based	NT-8	Noma Ln	Upsized existing pipe(s)	Negative Pressure	Yes	1,580	2,500	63%	8			278			278	< 0.1	2022-2027	upsized the 8-inch line in Noma Ln between Caudor St and Leora Ln to 12-inch line
1	Capacity-based	NT-9	Via Tiempo	Upsized existing pipe(s)	Negative Pressure	Yes	2,014	2,500	81%	8		1,173				1,173	0.2	2022-2027	upsized the 8-inch line in Via Tiempo between Wales Dr and Ruddy Duck Ct to 10-inch line
1	Capacity-based	NT-10	Edinburg Ave	Upsized existing pipe(s)	Pressure 1 psi	Yes	2,192	2,500	88%	6	601					601	0.1	2022-2027	upsized the 6-inch line in Edinburg Ave between Chesterfield Dr and Norfolk Dr to 8-inch line
1	Capacity-based	NT-11	Gascony Road	Upsized existing pipe(s)	Pressure 9 psi	Yes	2,075	2,500	83%	6 and 10			697	1,719		2,416	0.5	2022-2027	upsized ~1280 LF of 6-inch line and ~440 LF of the 10-inch line in Gascony Rd north of Capri Rd and south of 1687 Gascony Rd to 18-inch line; upsized the 10-inch line in Gascony Rd north of 1687 Gascony Rd and south of 1734 Gascony Rd to 16-inch line
2	Capacity-based	NT-12	Devonshire Drive	Upsized existing pipe(s)	Negative Pressure		1,786	3,500	51%	6	1,058	58	17			1,133	0.2	2022-2027	upsized the 6-inch line in Devonshire Dr. between the 12-inch line south of Requeza St and the 12-inch line in Melba Rd to 8-inch line; upsized the 6-inch line in Devonshire Dr. between the 6-inch line in Melba Rd and the 1st hydrant south Melba Rd to 10-inch line; upsized the 6-inch line segment in Melba Rd/Devonshire Dr between the 6-inch line and the 12-inch line to 12-inch line
2	Capacity-based	NT-13	2nd 3rd St Alley	Upsized existing pipe(s)	Negative Pressure		1,499	2,500	60%	6	981					981	0.2	2022-2027	upsized the 6-inch line in Alley between 2nd St and 3rd St between W E St and W H St to 8-inch line

Table 8-1. Proposed Capital Improvements

Priority	Type	Project #	Project Name	Note	Criteria Violated at Required Fire Flow	within VHFHSZ	Fire Flow (gpm)		Percent Available	Existing Diameter (in.)	Recommended Pipe Length per Diameter (feet)					Length (miles)	Phase	Additional Notes	
							Available	Required			8	10	12	16	18				Total
2	Capacity-based	NT-14	4th St	Upsized existing pipe(s)	Negative Pressure		1,854	3,000	62%	6	1,108					1,108	0.2	2022-2027	upsized the 6-inch line in 4th St between W E St and W G St to 8-inch line
2	Capacity-based	NT-15	I St & HWY 101	New looping pipe	Negative Pressure		1,615	2,500	65%	-	162					162	< 0.1	2022-2027	New 8-inch line north of W I St connecting the 12-inch line in S Coast Hwy 101 and the 6-inch line in Alley east of 2nd St
2	Capacity-based	NT-16	Regal Road	Upsized existing pipe(s)	Negative Pressure		1,630	2,500	65%	6	1,468	385	985			2,838	0.5	2022-2027	upsized the 6-inch line in Melba Rd between the Regal Rd and the 8-inch line near 528 Melba Rd to 12-inch line; upsized the 6-inch line in Regal Rd between Melba Rd and Park Ln to 12-inch line; upsized the 6-inch line in Regal Rd between Park Ln and the Private Rd to the North to 10-inch line; upsized the 6-inch line in the Private Rd west of Park Ln and north of Park Ln to 8-inch line
2	Capacity-based	NT-17	HWY 101, 2nd Alley	Upsized existing pipe(s)	Pressure 13 psi		1,597	2,500	64%	6	1,003					1,003	0.2	2022-2027	upsized the 6-inch line in Alley east of 2nd St between E E St and W G St to 8-inch line
2	Capacity-based	NT-18	Union Street	Upsized existing pipe(s)	Pressure 19 psi		2,165	3,000	72%	6	628					628	0.1	2022-2027	upsized the 6-inch line in Union Street between Vulcan St and Hermes Ave to 8-inch line
2	Capacity-based	NT-19	Mozart Ave	Upsized existing pipe(s)	Pressure 15 psi, Velocity 19 fps		2,415	3,000	81%	6	263					263	< 0.1	2022-2027	upsized the 6-inch line in Mozart Ave between Montgomery Ave and the 8-inch line to the south to 8-inch line
3	Condition-based	NT-20	Condition-based Project 4-1	Opportunistic AC Condition Assessment											0	< 0.1	2022-2027	Refer to Section 7.3.3 of Master Plan.	
4	Capacity-based	LT-1	La Veta Ave	Upsized existing pipe(s)	Velocity 21 fps		1,821	2,500	73%	6	392					392	< 0.1	2028-2032	upsized the 6-inch line in La Veta Ave between Marcheta St and the 2nd hydrant to 8-inch line
4	Capacity-based	LT-2	W J Street	Upsized existing pipe(s)	Velocity 20 fps		1,868	2,500	75%	6	129					129	< 0.1	2028-2032	upsized the 6-inch line north of W J St between 3rd St and Alley to 8-inch line
4	Capacity-based	LT-3	Soho Road	Upsized existing pipe(s)	Velocity 20 fps		1,919	2,500	77%	6	144					144	< 0.1	2028-2032	upsized the 6-inch line in Soho Rd between Piccadilly Rd and Kennington Rd to 8-inch line
4	Capacity-based	LT-4	Stater Brothers	Upsized existing pipe(s)	Velocity 20 psi		2,719	3,500	78%	8		250				250	< 0.1	2028-2032	upsized the 8-inch line in Town Central Pl in front of Stater Bros between the two hydrants south of Leucadia Blvd to 10-inch line
4	Capacity-based	LT-5	C St	Upsized existing pipe(s)	Velocity 19 fps		1,991	2,500	80%	6	109					109	< 0.1	2028-2032	upsized the 6-inch line in C St between 3rd St and the 1st hydrant to the east to 8-inch line
5	Water Quality	LT-6	Automatic Flusher	Automatic Flusher to Mitigate Water Quality Issues in 240 Zone	Water Quality					-					0	< 0.1	2028-2032	Automatic flusher near Via Poco and Manchester Ave to mitigate water age issues in 240 Zone	
5	Water Quality	LT-7	Santa Fe Dr	New Pipe & PRV Connecting 520 and 240 Zones	Water Quality					-				1,011	1,011	0.2	2028-2032	new PRS and new 12-inch line in Santa Fe Dr connecting the 12-inch line upstream of existing PRV near Santa Fe Dr and Nardo Rd from 520 Zone to 240 Zone. This project is to be after the successful implementation of LT-6.	

Table 8-1. Proposed Capital Improvements

Priority	Type	Project #	Project Name	Note	Criteria Violated at Required Fire Flow	within VHFHSZ	Fire Flow (gpm)		Percent Available	Existing Diameter (in.)	Recommended Pipe Length per Diameter (feet)					Length (miles)	Phase	Additional Notes	
							Available	Required			8	10	12	16	18				Total
5	Condition-based	LT-8	Condition-based Project 4-2	Opportunistic AC Condition Assessment											0	< 0.1	2028-2032	Refer to Section 7.3.3 of Master Plan.	
5	Capacity-based	LT-9	Burgundy Ave	Upsized existing pipe(s)	Pressure 13 psi		2,320	2,500	93%	8		1,629			1,629	0.3	2028-2032	upsized the 8-inch line in Burgundy Ave north of Capri Rd to 10-inch line to help improve fire flows in the VHFHSZ	
5	Capacity-based	LT-10	Kennington Road	Upsized existing pipe(s)	Pressure 12 psi		2,328	2,500	93%	6	390				390	< 0.1	2028-2032	upsized the 6-inch line in Kennington Rd between Soho Rd and the 1st hydrant north of Bishopgate Rd to 8-inch line	
5	Capacity-based	LT-11	Cornish Dr & HWY 101	New looping pipe	Pressure 10 psi, Velocity 16 fps		2,362	2,500	94%	-		144			144	< 0.1	2028-2032	Construct new 10-inch line west of Cornish Dr connecting the 6-inch in San Elijo Ave and the 8-inch line in Coast Hwy 101	
6	Condition-based	LT-12	Condition-based Project 5	CP, Appurtenance, & Contingency													2028-2032	Refer to Section 7.3.5 of Master Plan.	
															Total	27,989	5.3		

8.1.3. Improvements Related to Water Age

Additional CIP projects were developed to address system water age. Two projects were developed, including installing an automatic flusher in Via Poco and installing a connection between the 520 zone and the 240 zone in Santa Fe Avenue. The new interconnection in Santa Fe Avenue, which includes approximately 1,000 feet of new 12-inch pipe and a new PRS, is recommended only if the automatic flusher does not sufficiently improve water quality in the southern area of the 240 zone.

8.2. Phasing

The proposed CIP projects were prioritized in the following manner with Priority 1 being the highest priority:

Priority 1 – Pipeline improvements within the VHFHSZ for hydrants not meeting at least 90% of required fire flow and not meeting pressure criteria and high priority condition-based projects

Priority 2 - Pipeline improvements not in the VHFHSZ for hydrants not meeting at least 90% of required fire flow and not meeting pressure criteria

Priority 3 - Pipeline improvements within the VHFHSZ for hydrants not meeting at least 90% of required fire flow and not meeting velocity criteria and proactive condition-based project 4-1

Priority 4 - Pipeline improvements not in the VHFHSZ for hydrants not meeting at least 90% of required fire flow and not meeting velocity criteria and water quality enhancement project

Priority 5 - Pipeline improvements within the VHFHSZ for hydrants meeting more than 90% of required fire flow and not meeting velocity criteria and proactive condition-based project 4-2

Priority 6 – Medium priority proactive condition-based project

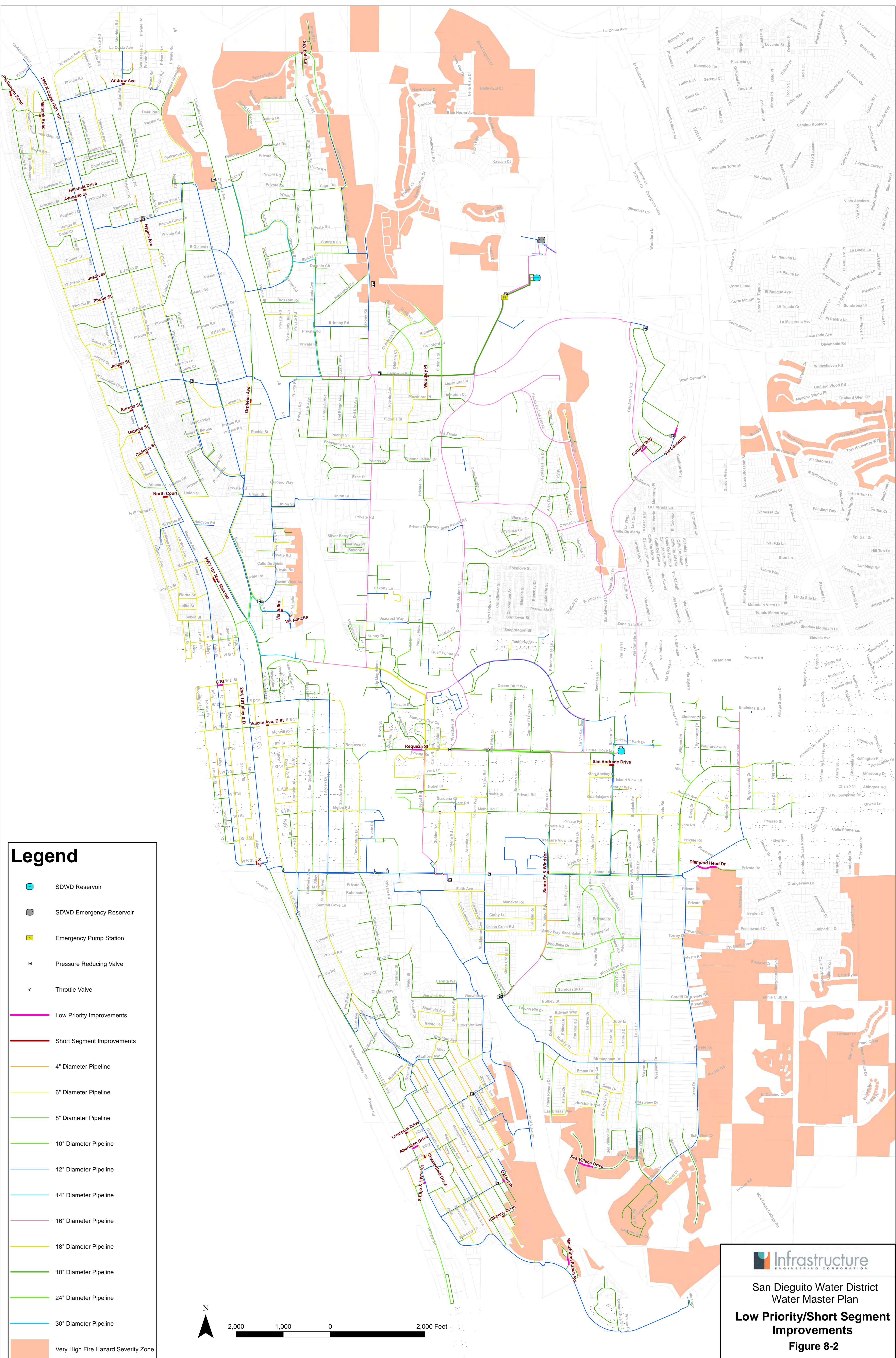
Projects with Priority 1 to Priority 3 are phased into 5-year CIP, and projects with Priority 4 to Priority 6 are phased into 10-year CIP, as shown in Table 8-1. Proposed projects identified to mitigate deficient hydrants meeting more than 90% of required fire flows and just slightly exceeding the velocity criteria and the low priority proactive condition-based project are considered low priority improvements, and are summarized in Table 8-2. In addition, there are a few short pipeline segments proposed for fire improvement, as summarized in Table 8-3. These proposed improvements are not within the VHFHSZ and are not practical to be standalone projects, therefore is considered low priority and optional. These low priority and optional improvements are not including in the 10-year CIP, but should be considered when the District is working on other system improvements within the vicinity or if there is a proposed development within the vicinity. Figure 8-2 shows the locations of these low priority improvements and short segment improvements.

Table 8-2. Low Priority Improvements (Optional)






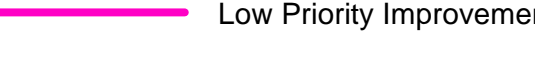
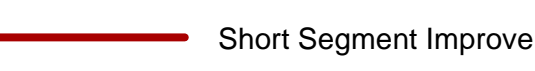



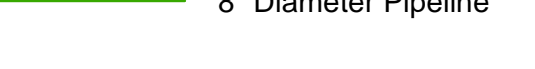
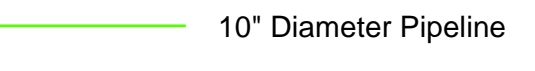



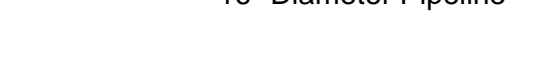
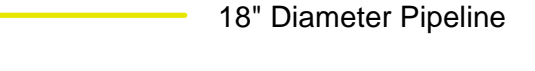
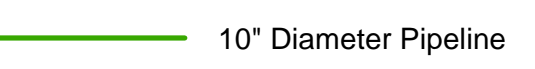

Project Name	Note	Criteria Violated at Required Fire Flow	within Wildfire Zone	Fire Flow (gpm)		Percent Available	Recommended Pipe Length per Diameter (feet)						Length (miles)	
				Available	Required		6	8	10	12	16	18		Total
Aberdeen Drive	Upsized existing pipe(s)	Velocity 17 fps		2,223	2,500	89%		126					126	< 0.1
Oxford Pl	Upsized existing pipe(s)	Velocity 17 fps	Yes	2,283	2,500	91%		49					49	< 0.1
Sky Loft Ln	Upsized existing pipe(s)	Velocity 16 fps	Yes	2,323	2,500	93%			167				167	< 0.1
Diamond Head Dr	Upsized existing pipe(s)	Velocity 16 fps	Yes	2,426	2,500	97%			416				416	< 0.1
Mackinnon Ranch Rd	Upsized existing pipe(s)	Velocity 16 fps	Yes	2,427	2,500	97%			167				167	< 0.1
Sea Village Drive	Upsized existing pipe(s)	Velocity 16 fps	Yes	2,428	2,500	97%			307				307	< 0.1
S Elijo & HWY 101	Upsized existing pipe(s)	Velocity 16 fps		2,387	2,500	95%			236				236	< 0.1
Via Cantabria	Upsized existing pipe(s)	Velocity 16 fps		3,366	3,500	96%			286				286	< 0.1
Cottage Way	Upsized existing pipe(s)	Velocity 16 fps		2,412	2,500	96%			121				121	< 0.1
Requeza St	Upsized existing pipe(s)	Velocity 16 fps		2,486	2,500	99%		208					208	< 0.1
Condition-based Project 6	Proactive Large Diameter Condition Assessment													
												2,084	0.4	

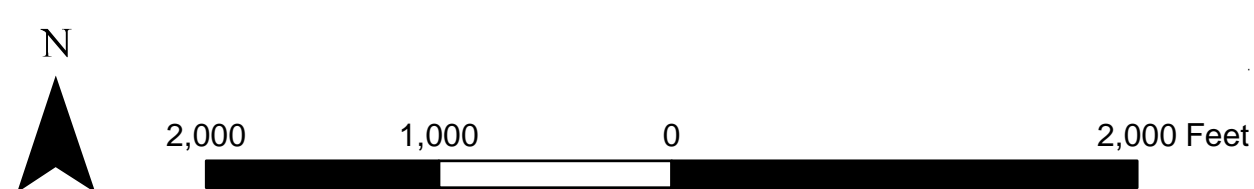
Table 8-3. Short Segment Improvements (Optional)

Project Name	Note	Criteria Violated at Required Fire Flow	within Wildfire Zone	Fire Flow (gpm)		Percent Available	Recommended Pipe Length per Diameter (feet)						Length (miles)	
				Available	Required		6	8	10	12	16	18		Total
2nd, 101 Alley & D St	Connect to 8 inch, Upsize	Negative Pressure		2,070	2,500	83%		20					20	< 0.1
K St	Upsized existing pipe(s)	Pressure 5 psi, Velocity 37 fps		1,563	2,500	63%		56					56	< 0.1
North Court	Upsized existing pipe(s)	Pressure 8 psi, Velocity 25 fps		1,277	1,500	85%	99						99	< 0.1
Woodley Pl	Check as-builts, confirm pipe diameter	Velocity 34 fps		679	1,500	45%		11					11	< 0.1
Jasper St	Check as-builts, confirm pipe diameter	Velocity 26 fps		1,500	2,500	60%		8					8	< 0.1
Hillcrest Drive	Upsized existing pipe(s)	Velocity 25 fps		1,500	2,500	60%				32			32	< 0.1
Cadmus St	Upsized existing pipe(s)	Velocity 26 fps		1,516	2,500	61%				18			18	< 0.1
Phobe St	Upsized existing pipe(s)	Velocity 26 fps		1,519	2,500	61%		10					10	< 0.1
Jason St	Upsized existing pipe(s)	Velocity 25 fps		1,532	2,500	61%		15					15	< 0.1
Milbank Road	Upsized existing pipe(s)	Velocity 25 fps		1,572	2,500	63%		23					23	< 0.1
1950 N Coast HWY 101	Check as-builts, confirm pipe diameter	Velocity 24 fps		1,597	2,500	64%					1		1	< 0.1
Daphne St	Upsized existing pipe(s)	Velocity 24 fps		1,598	2,500	64%		20					20	< 0.1
San Andrade Drive	Upsized existing pipe(s)	Velocity 24 fps		1,928	3,000	64%				80			80	< 0.1
Avocado St	Upsized existing pipe(s)	Velocity 22 fps		1,790	2,500	72%		28					28	< 0.1
Orpheus Ave	Upsized existing pipe(s)	Velocity 21 fps		1,822	2,500	73%		53					53	< 0.1
Europa St	Upsized existing pipe(s)	Velocity 21 fps		1,835	2,500	73%		51					51	< 0.1
Chesterfield Drive	Upsized existing pipe(s)	Velocity 20 fps		1,906	2,500	76%		36					36	< 0.1
Vulcan Ave, E St	Upsized existing pipe(s)	Velocity 19 fps		1,974	2,500	79%		28					28	< 0.1
Parliament Road	Upsized existing pipe(s)	Velocity 16 fps		2,124	2,500	85%		84					84	< 0.1
Andrew Ave	Upsized existing pipe(s)	Velocity 17 fps		1,359	1,500	91%		41					41	< 0.1
Via Julita	Upsized existing pipe(s)	Velocity 17 fps		1,363	1,500	91%		29					29	< 0.1
Kilkenny Drive	Upsized existing pipe(s)	Velocity 17 fps		1,385	1,500	92%		25					25	< 0.1
HWY 101 Near Marchet	Upsized existing pipe(s)	Velocity 16 fps		2,325	2,500	93%		77					77	< 0.1
Santa Fe & Windsor	Upsized existing pipe(s)	Velocity 16 fps		2,850	3,000	95%				28			28	< 0.1
Liverpool Drive	Upsized existing pipe(s)	Velocity 16 fps		2,406	2,500	96%		45					45	< 0.1
Hygeia Ave	Upsized existing pipe(s)	Velocity 16 fps		1,465	1,500	98%		12					12	< 0.1
Via Nancita	Upsized existing pipe(s)	Velocity 17 fps		1,363	1,500	91%				29			29	< 0.1



Legend

-  SDWD Reservoir
-  SDWD Emergency Reservoir
-  Emergency Pump Station
-  Pressure Reducing Valve
-  Throttle Valve
-  Low Priority Improvements
-  Short Segment Improvements
-  4" Diameter Pipeline
-  6" Diameter Pipeline
-  8" Diameter Pipeline
-  10" Diameter Pipeline
-  12" Diameter Pipeline
-  14" Diameter Pipeline
-  16" Diameter Pipeline
-  18" Diameter Pipeline
-  10" Diameter Pipeline
-  24" Diameter Pipeline
-  30" Diameter Pipeline
-  Very High Fire Hazard Severity Zone



San Diego Water District
 Water Master Plan
**Low Priority/Short Segment
 Improvements**
Figure 8-2

8.3. Cost Estimates

8.3.1. Unit Costs

Unit costs used to develop the capital cost estimates were based on research of similar studies completed in the past 10 years as well as recent bid results for similar projects. The cost estimates in this study are provided for planning purposes and represent “Class 4 for Studies or Feasibility Report” level costs as established by the American Association of Cost Engineers (AACE), with an accuracy of +50% to -30%. Unit costs shown in this study include an additional 30% for soft costs including but not limited to planning, design, legal, and administration costs. In addition, prices of materials and labor fluctuate with time, new estimates should be obtained during the preliminary design of proposed facilities to confirm budget amounts. Table 8-4 and Table 8-5 presents the unit costs for pipelines and valves, respectively. Unit costs for the pipelines listed herein consider costs associated with pipeline improvement projects with relatively short length that increase mobilization and demobilization work during construction.

Table 8-4. Pipeline Unit Costs

Size	Capital Unit Cost (\$/LF)
6	425
8	462
10	517
12	554
16	739
18	776

*All cost assumptions are based on the ENR CCI of 13212 in Los Angeles September 2021.

** Costs include 30% soft costs including but not limited to planning, design, legal, and administration costs

Table 8-5. Unit Costs for other facilities

Type	Capital Unit Cost (\$/ea.)
Automatic Flushing Station	200,000
Pressure Reducing Station	250,000

*All cost assumptions are based on the ENR CCI of 13212 in Los Angeles September 2021.

** Costs include 30% soft costs including but not limited to planning, design, legal, and administration costs

*** Costs include purchase price and construction costs.

8.3.2. Capital Costs

Capital costs of the proposed CIP improvements, low priority improvements, and short segment improvements are estimated based on the unit costs discussed above and are summarized in Table 8-6, Table 8-7, and Table 8-8, respectively. Table 8-9 listed the cost breakdown by pipe size for the proposed CIP improvements. The capital costs for the 5-Yr CIP is estimated to be approximately \$10.3 million dollars, and the capital costs for the 10-Yr CIP is estimated to be approximately \$5.6 million dollars.

Table 8-6. Summary Capital Improvement Cost Estimates

Priority	Project #	Type	Project Name	Estimated Capital Costs (\$)	Phase
1	NT-1	Condition-based	Condition-based Project 1	599,000	2022-2027
1	NT-2	Condition-based	Condition-based Project 2	963,000	2022-2027
1	NT-3	Condition-based	Condition-based Project 3	1,377,000	2022-2027
1	NT-4	Capacity-based	Alley/Montgomery	541,000	2022-2027
1	NT-5	Capacity-based	Andrew/Leucadia Scenic	416,000	2022-2027
1	NT-6	Capacity-based	Avocet Ct	131,000	2022-2027
1	NT-7	Capacity-based	Eolus Ave	736,000	2022-2027
1	NT-8	Capacity-based	Noma Ln	118,000	2022-2027
1	NT-9	Capacity-based	Via Tiempo	498,000	2022-2027
1	NT-10	Capacity-based	Edinburg Ave	256,000	2022-2027
1	NT-11	Capacity-based	Gascony Road	1,027,000	2022-2027
2	NT-12	Capacity-based	Devonshire Drive	482,000	2022-2027
2	NT-13	Capacity-based	2nd 3rd St Alley	417,000	2022-2027
2	NT-14	Capacity-based	4th St	471,000	2022-2027
2	NT-15	Capacity-based	I St & HWY 101	69,000	2022-2027
2	NT-16	Capacity-based	Regal Road	1,206,000	2022-2027
2	NT-17	Capacity-based	HWY 101, 2nd Alley	426,000	2022-2027
2	NT-18	Capacity-based	Union Street	267,000	2022-2027
2	NT-19	Capacity-based	Mozart Ave	112,000	2022-2027
3	NT-20	Condition-based	Opportunistic AC Condition Assessment	225,000	2022-2027
5-Yr CIP Total (\$)				10,337,000	
4	LT-1	Capacity-based	La Veta Ave	167,000	2028-2032
4	LT-2	Capacity-based	W J Street	55,000	2028-2032
4	LT-3	Capacity-based	Soho Road	61,000	2028-2032
4	LT-4	Capacity-based	Stater Brothers	106,000	2028-2032
4	LT-5	Capacity-based	C St	47,000	2028-2032
5	LT-6	Water Quality	Automatic Flusher	200,000	2028-2032
5	LT-7	Water Quality	Santa Fe Dr	680,000	2028-2032
5	LT-8	Condition-based	Opportunistic AC Condition Assessment	225,000	2028-2032
5	LT-9	Capacity-based	Burgundy Ave	692,000	2028-2032
5	LT-10	Capacity-based	Kennington Road	166,000	2028-2032
5	LT-11	Capacity-based	Cornish Dr & HWY 101	61,000	2028-2032
6	LT-12	Condition-based	CP, Appurtenance, & Contingency	3,130,000	2028-2032
10-Yr CIP Total (\$)				5,590,000	
Total (\$)				15,927,000	

* Costs are rounded to the nearest thousands.

Table 8-7. Summary of Low Priority Improvement Costs Estimates

Project Name	Estimated Cost (\$)
Aberdeen Drive	\$ 58,000
Oxford Pl	\$ 23,000
Sky Loft Ln	\$ 86,000
Diamond Head Dr	\$ 215,000
Mackinnon Ranch Rd	\$ 86,000
Sea Village Drive	\$ 159,000
S Elijo & HWY 101	\$ 122,000
Via Cantabria	\$ 148,000
Cottage Way	\$ 63,000
Requeza St	\$ 96,000
Condition-based Project 6	\$ 2,500,000
Total	\$ 3,556,000

* Costs are rounded to the nearest thousands.

Table 8-8. Summary of Short Segment Improvement Costs Estimates

Project Name	Estimated Cost (\$)
2nd, 101 Alley & D St	\$ 9,000
K St	\$ 26,000
North Court	\$ 42,000
Woodley Pl	\$ 5,000
Jasper St	\$ 4,000
Hillcrest Drive	\$ 17,000
Cadmus St	\$ 10,000
Phobe St	\$ 5,000
Jason St	\$ 7,000
Milbank Road	\$ 10,000
1950 N Coast HWY 101	\$ 1,000
Daphne St	\$ 9,000
San Andrade Drive	\$ 41,000
Avocado St	\$ 13,000
Orpheus Ave	\$ 25,000

Table 8-8. Summary of Short Segment Improvement Costs Estimates

Project Name	Estimated Cost (\$)
Europa St	\$ 23,000
Chesterfield Drive	\$ 17,000
Vulcan Ave, E St	\$ 13,000
Parliament Road	\$ 39,000
Andrew Ave	\$ 19,000
Via Julita	\$ 14,000
Kilkenny Drive	\$ 12,000
HWY 101 Near Marchet	\$ 36,000
Santa Fe & Windsor	\$ 15,000
Liverpool Drive	\$ 21,000
Hygeia Ave	\$ 6,000
Via Nancita	\$ 15,000
Total	\$ 454,000

* Costs are rounded to the nearest thousands.

Table 8-9. Summary Capital Improvement Cost Estimates

Priority	Project #	Type	Project Name	Existing Diameter (in.)	Estimated Capital Costs (\$)						Length (miles)	Phase	
					8 in.	10 in.	12 in.	16 in.	18 in.	Valve			Total (\$)
1	NT-1	Condition-based	Condition-based Project 1	6	598,825	0	0	0	0		599,000	0.3	2022-2027
1	NT-2	Condition-based	Condition-based Project 2	6 and 12	631,975	0	331,500	0	0		963,000	0.4	2022-2027
1	NT-3	Condition-based	Condition-based Project 3	6 and 12	1,020,000	0	357,000	0	0		1,377,000	0.2	2022-2027
1	NT-4	Capacity-based	Alley/Montgomery	4 and 6	540,870	0	0	0	0		541,000	< 0.1	2022-2027
1	NT-5	Capacity-based	Andrew/Leucadia Scenic	8	0	415,699	0	0	0		416,000	0.2	2022-2027
1	NT-6	Capacity-based	Avocet Ct	6	0	0	130,900	0	0		131,000	0.2	2022-2027
1	NT-7	Capacity-based	Eolus Ave	2 and 6	282,020	454,357	0	0	0		736,000	0.1	2022-2027
1	NT-8	Capacity-based	Noma Ln	8	0	0	118,135	0	0		118,000	0.3	2022-2027
1	NT-9	Capacity-based	Via Tiempo	8	0	498,496	0	0	0		498,000	< 0.1	2022-2027
1	NT-10	Capacity-based	Edinburg Ave	6	255,505	0	0	0	0		256,000	0.2	2022-2027
1	NT-11	Capacity-based	Gascony Road	6 and 10	0	0	0	296,083	730,738		1,027,000	0.1	2022-2027
2	NT-12	Capacity-based	Devonshire Drive	6	449,690	24,687	7,197	0	0		482,000	0.2	2022-2027
2	NT-13	Capacity-based	2nd 3rd St Alley	6	417,093	0	0	0	0		417,000	0.2	2022-2027
2	NT-14	Capacity-based	4th St	6	471,004	0	0	0	0		471,000	< 0.1	2022-2027
2	NT-15	Capacity-based	I St & HWY 101	-	68,822	0	0	0	0		69,000	0.5	2022-2027
2	NT-16	Capacity-based	Regal Road	6	623,836	163,556	418,645	0	0		1,206,000	0.2	2022-2027
2	NT-17	Capacity-based	HWY 101, 2nd Alley	6	426,227	0	0	0	0		426,000	0.1	2022-2027
2	NT-18	Capacity-based	Union Street	6	266,784	0	0	0	0		267,000	0.2	2022-2027
2	NT-19	Capacity-based	Mozart Ave	6	111,672	0	0	0	0		112,000	0.5	2022-2027
3	NT-20	Condition-based	Opportunistic AC Condition Assessment		0	0	0	0	0		225,000	< 0.1	2022-2027
5-Yr CIP Total (\$)											10,337,000		
4	LT-1	Capacity-based	La Veta Ave	6	166,567	0	0	0	0		167,000	< 0.1	2028-2032
4	LT-2	Capacity-based	W J Street	6	54,868	0	0	0	0		55,000	< 0.1	2028-2032
4	LT-3	Capacity-based	Soho Road	6	61,155	0	0	0	0		61,000	0.6	2028-2032
4	LT-4	Capacity-based	Stater Brothers	8	0	106,041	0	0	0		106,000	< 0.1	2028-2032
4	LT-5	Capacity-based	C St	6	46,534	0	0	0	0		47,000	< 0.1	2028-2032
5	LT-6	Water Quality	Automatic Flusher	-	0	0	0	0	0	200,000	200,000	< 0.1	2028-2032
5	LT-7	Water Quality	Santa Fe Dr	-	0	0	0	429,777	0	250,000	680,000	< 0.1	2028-2032
5	LT-8	Condition-based	Opportunistic AC Condition Assessment		0	0	0	0	0		225,000	< 0.1	2028-2032
5	LT-9	Capacity-based	Burgundy Ave	8	0	692,466	0	0	0		692,000	< 0.1	2028-2032
5	LT-10	Capacity-based	Kennington Road	6	165,542	0	0	0	0		166,000	< 0.1	2028-2032
5	LT-11	Capacity-based	Cornish Dr & HWY 101	-	0	61,237	0	0	0		61,000	< 0.1	2028-2032
6	LT-13	Condition-based	CP, Appurtenance, & Contingency		0	0	0	0	0		3,130,000	< 0.1	2028-2032
10-Yr CIP Total (\$)											5,590,000		
Total (\$)											15,927,000	5.3	

* Costs are rounded to the nearest thousands.

Appendix A. Model Results Tables and Figures

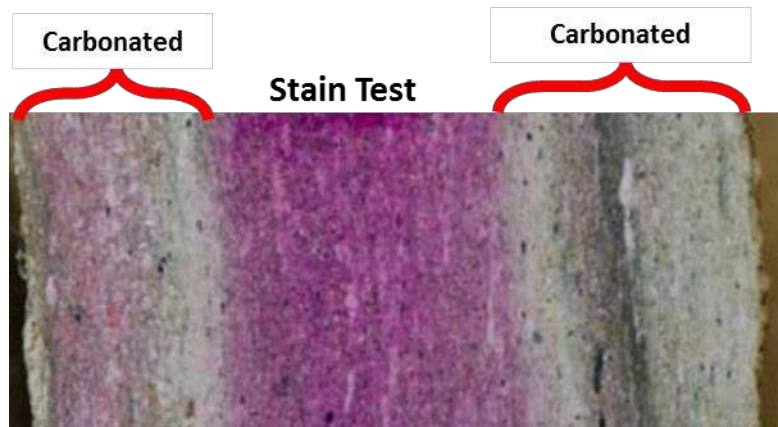
Appendix B. AC Pipe Deterioration

Based on the soil characteristics of the system, cement leaching is likely the dominant corrosion driver. Cement leaching follows a two-step process as documented in Water Research Foundation Project 4480 – Development of an Effective Strategy for Asbestos Cement Pipe:

- Step 1 – Conversion of free lime ($\text{Ca}(\text{OH})_2$) to calcium carbonate (CaCO_3)
- Step 2 – Calcium dissolution and removal

The first step involves the conversion of free lime to calcium carbonate. This step can be measured by applying phenolphthalein to a freshly exposed cross-section of the pipe wall (i.e., stain test). The portion of the pipe wall that stains is un-carbonated. The portion of the pipe wall that is unstained is carbonated. Figure 1 shows a pipe that has been tested where the left side is the inner portion of the pipe wall and the right side is the outer portion of the pipe wall.

Figure 1. Stain Test Results



Carbonation starts at both the inner and outer wall surfaces. Over time, it progresses towards the center of the pipe wall which is typically un-carbonated. In AC and other non-reinforced concrete applications, carbonation itself does not weaken the pipe. In fact, studies show a minor strengthening effect after carbonation. However, in AC pipes, carbonation may lead to calcium leaching, particularly on the inside of the pipe.

In Step 2 of the AC pipe corrosion process, if the environment allows for calcium carbonate to be dissolved and carried away, calcium may then leach from the calcium-silicate-hydrate and other cement products in the concrete matrix. When this occurs, strength is lost and the pipe becomes more susceptible to failure.

The extent of calcium leaching can be measured by using the Energy Dispersive X-Ray Spectroscopy (EDS test). Figure shows the EDS test results for the same sample shown in Figure 1. In this test, calcium content is measured at multiple points (i.e. wall locations) along the thickness of the pipe. At installation, calcium content was relatively uniform across the pipe wall thickness. As the AC pipe wall corrodes from the inner and outer wall surfaces towards the center of the wall, the calcium content will be significantly lower than the calcium content at the center of the pipe wall.

The remaining calcium content at each wall location is reported as a percentage of the elements tested. Figure 1 shows the calcium content at each location relative to the maximum calcium content measured at all locations along the wall. Where the remaining calcium content is high, the material retains its original strength. Where the remaining calcium content is relatively low, the material has lost strength. Typically, active corrosion is occurring over a relatively narrow portion of the pipe wall.

Figure 2. EDS Test Results

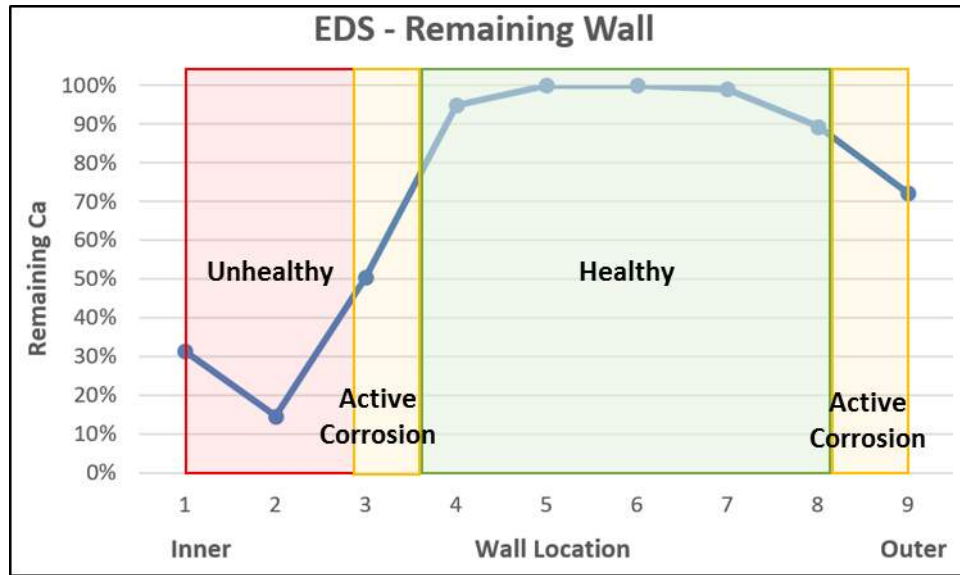
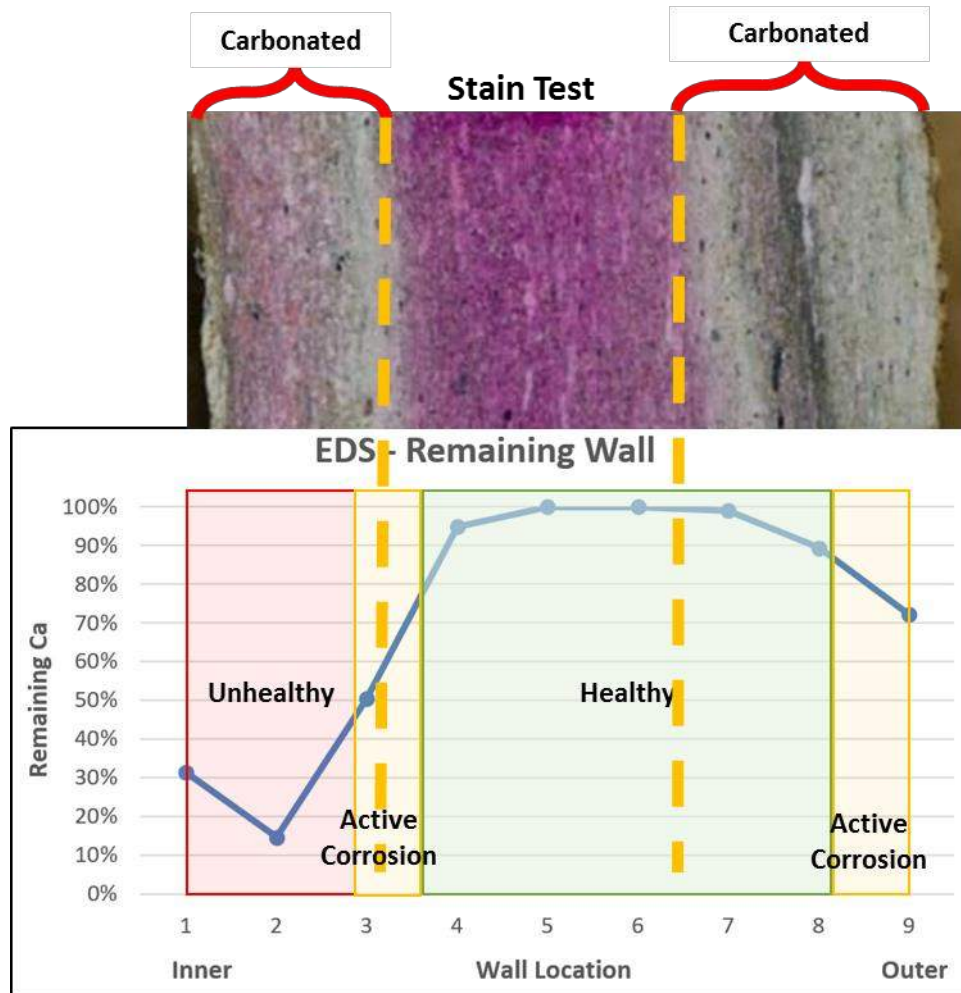


Figure 3 orients both tests for a single sample to each other to correlate the results. On the inner portion of the pipe wall, the fresh water conveyed by the pipe is an ideal medium to dissolve calcium carbonate and carry away calcium from the pipe wall (Step 2 of the corrosion process). As a result, carbonation (Step 1) results in calcium leaching (Step 2). The speed at which this happens depends on how aggressive the water is. If the water is hard (lots of calcium carbonate), the dissolution of calcium proceeds more slowly than if the water is soft. This means that Stain and EDS tests typically correlate very well to each other on the inner pipe wall. However, on the outer pipe wall, there is often not a consistent medium to dissolve and carry away the calcium carbonate. Therefore, carbonation and calcium leaching often do not correlate on the outside of the pipe.

Figure 3. EDS versus Stain Test Correlation



While the physical wall thickness does not change over time, the effective wall thickness decreases over time as calcium leaches from the pipe wall. This thinning of the effective wall will continue until the effective wall thickness can no longer resist the stresses on the pipe (e.g. internal pressure, external loads, bending due to ground movement) resulting in a break. EDS testing measures the effective wall thickness.

Appendix C. Using Condition Data to Support Decision Making

This section documents findings from analysis of opportunistic assessments of AC pipe at other utilities and how that data is used to support decision making.

In theory, the likelihood of failure (LoF) of AC pipe is dependent upon the pipe condition (i.e. percent of remaining wall thickness) and the stress a pipe is exposed to. Industry experience¹ suggests that the predominant AC pipe stressors are ground movement and pressure (both static and pressure variations). Pipes in worse condition that are exposed to higher stresses should break more often. To begin to quantify the relationship between readily available condition assessment, stress, and break data, HDR consolidated data from nine utilities in California² into a single database. One hundred and ninety two (192) samples were analyzed.

For this analysis, the likelihood of ground movement was estimated using the linear extensibility percentage (LEP) of the soils below the pipe based on USGS data. USGS data measure broad changes in soil characteristics. One pressure variation example from a utility is where a treatment plant only operates for a few months per year (during peak seasonal flows) and can result in static pressure changes of up to 40 psi in certain neighborhoods. In another system, a sample was taken near a pump station known to induce pressure changes so this sample was characterized as having a highly variable pressure. Abnormal loading conditions were also considered a significant stressor. In one system, two samples were identified as being directly below a storm drain. Loading conditions varied depending upon how full the storm drain was operating.

An effort was made to exclude non-condition related breaks such as dig-ins and corroded couplings. The quality of pressure data, ground movement data, and break data varied widely by utility and over time which is expected to result in a moderate margin of error. As additional data are collected, it is expected that this margin of error will diminish.

Industry experience³ suggests that historic breaks are a good indicator of future breaks and that as a pipe experiences more breaks, the average duration until the next break becomes shorter. Therefore, an analysis was conducted on the Consolidated Testing Database to estimate the relationship between stress, condition⁴, and break history. The relationship observed was categorized into five EDS LoF ratings summarized in Figure 1.

¹ Based on findings from Water Research Foundation Project 4480 – “Effective Management of Asbestos Cement Pipe” and HDR’s experience with other utilities including the City of Phoenix, Contra Costa WD, East Bay MUD, Padre Dam MWD, Suburban Water Systems, Orange Water and Sewer Authority, Vista irrigation District, Santa Cruz, and Amarillo Texas.

² Mesa Water District, Suburban Water Systems, Contra Costa WD, Irvine Ranch WD, Carlsbad, San Dieguito WD, East Bay MUD, Padre Dam MWD, and Walnut Valley WD

³ Based on findings from Water Research Foundation Project 4367 – “Answers to Challenging Infrastructure Management Questions” and experience with other utilities including the City of Phoenix, Contra Costa WD, East Bay MUD, Suburban Water Systems, Orange Water and Sewer Authority, Vista irrigation District, Santa Cruz, Lincoln Nebraska, Eugene Oregon, Des Moines Iowa, Rainbow MWD Richardson Texas, Rochester Minnesota, Westminster Colorado, Boulder Colorado, Olathe Kansas, Honolulu Hawaii, Bellevue Washington, and Amarillo Texas.

⁴ Condition was measures based on the remaining wall thickness based on Energy Dispersive Spectroscopy testing. The remaining wall thickness is calculated as the average remaining calcium at all wall locations divided by the maximum remaining calcium as defined in Mesa Water District’s Pipeline Integrity Testing Program Technical Memorandum.

Figure 1. EDS LoF Rating System

Percent Remaining Wall	Stress	
	Low	High
Less than 52%	N/A	Very High
52% to 57%	Moderate	Very High
57% to 62%	Moderate	High
62% to 67%	Low	High
67% to 73%	Low	Moderate
73% to 82%	Low	Low
82% to 83%	Very Low	Low
More than 83%	Very Low	Very Low

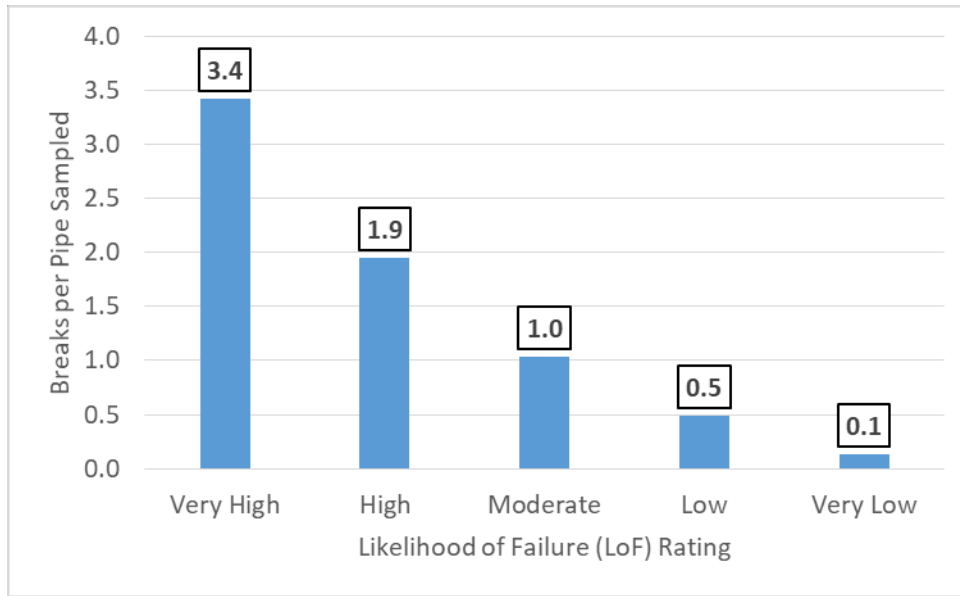
Where stress is defined as:

- Higher Stress
 - Pipes with known high pressure swings or abnormal loading conditions OR
 - Pipes with higher pressure (more than 70 psi) and moderate ground movement potential (LEP of 4 or more) OR
 - Pipes with lower pressure (less than or equal to 70 psi) and high ground movement (LEP of 7.5 or more)
- Lower Stress
 - Pipes with higher pressure (more than 70 psi) and low ground movement potential (LEP of less than 4) OR
 - Pipes with lower pressure (less than 70 psi) and moderate to low ground movement potential (LEP of less than 6)

Figure 2 summarizes the average breaks per pipe⁵ sampled by EDS LoF Rating. For example, of the twelve samples that qualified as Very High LoF, there was an average of 3.4 breaks per sample. Conversely, of the twenty three samples that qualified as Very Low LoF, there was an average of 0.1 breaks per sample. While the industry is still learning how to quantify stress, condition, and LoF in AC pipes; the data analyzed thus far show good correlation and aligns with industry experience that pipes exposed to higher stresses and in worse condition have a higher LoF.

⁵ For this analysis, the extents of the “pipe” sampled is defined by each utility’s pipe grouping methodology. Like the District, most utilities in this study group pipes by construction installation job number and plan and profile sheet number. This results in a “pipe” that is generally between 500’ and 3,000’ long.

Figure 2 – Average Break Rate by EDS LoF Rating



Comparing data from different utilities can be useful in understanding how EDS test data can be used in the future, particularly when relatively few District data points are available. However, this approach does have limitations as risk tolerances, operating conditions, and data quality varies significantly from utility to utility. As the District's data set becomes larger, the relationship between pipe condition, pipe stress, and breaks will become clearer within the District's unique operating environment.

While EDS accurately measures the condition at a point along a pipeline, it is not yet clear how far that condition can be extrapolated along a pipe length. The condition of AC pipe would be expected vary significantly from one construction project to another, because of differences in year of installation, construction practices, and manufacturing quality. Differences in condition within a single project should be less variable but will exist due to manufacturing variability, isolated damage during construction, variations in loading, and soil conditions. Therefore, the industry currently has high confidence in the condition at the point of the sample, moderate confidence in extrapolating the condition to the project as a whole, and low confidence extrapolating the condition beyond the project.

The District has collected some Echologics ePulse data. This technology transmits a sound wave through the pipe and measures the speed at which the soundwave travels between two appurtenances to estimate the average pipe wall thickness. Appurtenances are often spaced several hundred feet apart. While research has shown the ePulse is not as accurate as EDS data, when paired with EDS data, it can be useful in extrapolated condition assessment results to determine the appropriate project extents.

The recommended process for evaluating each new sample collected is:

1. Associate the sample to the appropriate pipe
2. Calculate the percent remaining wall
3. Within GIS, review the condition results, loading conditions, break history, ePulse data, construction project boundaries, and other projects that may be going on in the area.
4. Refine decision making (e.g. operate, condition assessment, renewal).

As the District collects and evaluates more samples, District specific relationships between condition, stress, and risk can be established and integrated into the risk model. Even when data are sufficient to integrate directly into an automated condition-based risk equation, it is unlikely that this equation will replace good engineering and operational judgment. Rather, the condition-based risk model will likely focus this engineering and operational judgment in the portions of the system that are likely to require condition assessment or renewal.

Each of the eleven samples was associated to the pipe sampled (i.e. District unique GIS ID) based upon the documented address and the pipe diameter. The pipe attributes, lab testing results, historic breaks, and the application of the decision making guidelines from the previous section are summarized in Table 1.

Table 1. Summary of EDS Testing Results

Lab Sample ID	Asset	Dia (in)	Install Year	Pressure (psi)	LEP	Stress	Wall Remaining (%)	LoF Rating	Breaks
WO-62-1	34082WMAIN	12	1962	57	1.5	Low	69.8%	Low	0
WO-83-5	22041WMAIN	12	1955	72	1.5	High	76.5%	Low	0
WO-56-37	22431WMAIN	6	1956	71	1.5	High	74.2%	Low	0
WO-59-59	14454WMAIN	6	1959	86	1.5	High	69.8%	Moderate	0
WO-53-8	17303WMAIN	6	1953	87	1.5	High	59.7%	High	1
WO-82-115	37324WMAIN	8	1982	80	1.5	High	67.8%	Moderate	0
WO-75-40	37541WMAIN	10	1975	95	1.5	High	77.7%	Low	0
WO-52-18	15570WMAIN	6	1952	65	1.5	Low	61.8%	Moderate	0
WO-53-12	34104WMAIN	8	1953	76	1.5	High	83.1%	Very Low	0
WO-61-7	33496WMAIN	6	1961	85	1.5	High	63.6%	High	3
WO-60-45	36465WMAIN	6	1960	91	1.5	High	71.6%	Moderate	0

Appendix D. Corrosion of Metallic Pipe

The three prominent metallic materials in the District's system are Cast Iron, Ductile Iron, and Steel pipe. The following discussion was developed directly from Water Research Foundation Project 4367: Answers to Challenging Infrastructure Management Questions. With iron pipes, the aging process is well recognized. Deterioration occurs through corrosion, which generally takes the form of pitting. These pits can result in holes in the pipe, and leakage. However, leakage does not always occur, or occur right away when pits completely penetrate the iron. Often the water is held back by scale, mortar lining, and graphite. Corrosion failures of pitted iron pipes occur from three general mechanisms:

1. Rust hole or blow out. A pit penetrates the pipe and grows sufficiently large for leakage to occur.
2. Longitudinal Split. Pitting weakens a large enough portion of the pipe that it splits longitudinally. Longitudinal splits can also occur where general corrosion has weakened the pipe so that hoop strength is less than hoop stress.
3. Circumferential crack. The pipe is sufficiently weakened that bending or axial stresses cause a circumferential fracture.

In the first two cases, internal pressure is a contributing factor—higher pressures increase the likelihood of failure. In the third case, ground movement is often a contributing factor, with failures sometimes triggered by colder-than-normal water (axial contraction). Pipe bending from ground movement can also cause failures when corrosion is absent.

The chief difference between ductile iron and cast iron is the form of carbon within the metal matrix. Rather than the graphite flakes found in cast iron, carbon in ductile iron is formed into round nodules. This form does not tend to propagate cracks, making the material much less brittle. Because of this, ductile iron is less prone to longitudinal or circumferential cracking (Cases 2 and 3). However, when equally unprotected, both types of pipe are equally vulnerable to rust-hole failures.

Steel pipe is different from cast or ductile iron in two important ways: (1) steel pipe has traditionally been designed to more precise thicknesses (without a significant corrosion allowance) and (2) corrosion of steel does not leave behind a graphite residue. These differences have meant that steel has historically been viewed as more vulnerable to corrosion, and therefore was often better protected from corrosion than cast iron when first installed.

Appendix E. Large Metallic Pipe Condition Assessment Strategy

This appendix described the District's condition assessment strategy for metallic pipes. For all pipes, it is assumed that a soil corrosivity assessment (shown in Figure 1) will be performed to support condition assessment. This will include Emag survey, approximately one soil sample per mile of pipe surveyed, and a report interpreting the data and recommending next actions.

Figure 1. Example of Soil Survey



For pipes less critical mains (often 16-inches or less) with existing CP test stations, in lieu of more expensive and disruptive high resolution in pipe technology, it may be appropriate to use close-interval survey (or cell-to-cell testing in paved areas) to measure the location and severity of active corrosion (shown in Figure 2). This information will be used to determine whether excavation and measurement of pipe wall thickness is warranted.

Figure 2. Example of Close-Interval Survey

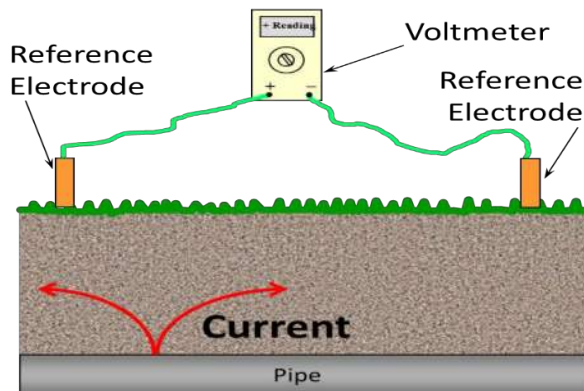


Figure 3. Example of Targeted Excavation and Measurement of Pipe Wall Thickness



For all other metallic pipes, it is assumed that higher resolution in-pipe electromagnetic technology will be required to make prudent and justifiable decisions.

Figure 4. Example of In-Pipe Electromagnetic Technology



Appendix F. Large AC Pipe Condition Assessment Strategy

While no single condition assessment technique provides the data required to make prudent decisions on large and consequential AC pipe, leveraging multiple techniques simultaneously will result in cost-effective decision making. The proposed technical approach is based upon the practical application of Water Research Foundation Study 4480 – Effective Management for Asbestos Cement Pipe and is described below.

The predominant drivers for AC pipe deterioration are cement leaching and salt cracking (i.e. salts migrate into cracks and pore space through capillary and evaporation processes, then expand when hydrated). Direct pipe sampling and testing⁶ provides accurate condition measurements at a single location along the pipeline. However, because the condition of an AC pipe often varies, it is difficult to extrapolate sample data to the entire pipeline. Research has shown that the ePulse technology⁷ is effective at measuring the relative condition of long AC pipe alignments like the District’s large pipelines, but does not provide data of sufficient accuracy to make decisions on infrastructure as critical and expensive as this pipeline. Soil sampling can support data driven estimates of future deterioration rates by measuring the aggressiveness of the soils in reducing the pipe strength. As summarized in Table 1, each of these techniques have different key strengths and limitations. However, by leveraging these techniques together, the assessment limitations of using only one technology can be overcome to provide data of sufficient quality and quantity to make prudent decisions regarding the best way to manage these transmission lines. Further cost savings can be realized by collecting soil and pipe samples (through hot-tapping) during excavations required for the ePulse⁸.

Table 1 – Technologies Required for Prudent Decision Making & Remaining Useful Life Estimation

Assessment Needs	Technologies (Strengths)			
	ePulse	EDS Testing	Petrographic	Soil Sampling
Salt Cracking			X	
Cement Leaching		X		
Relative Average Condition between access points	X			
Deterioration Potential				X
Detect Active Leaks	X			

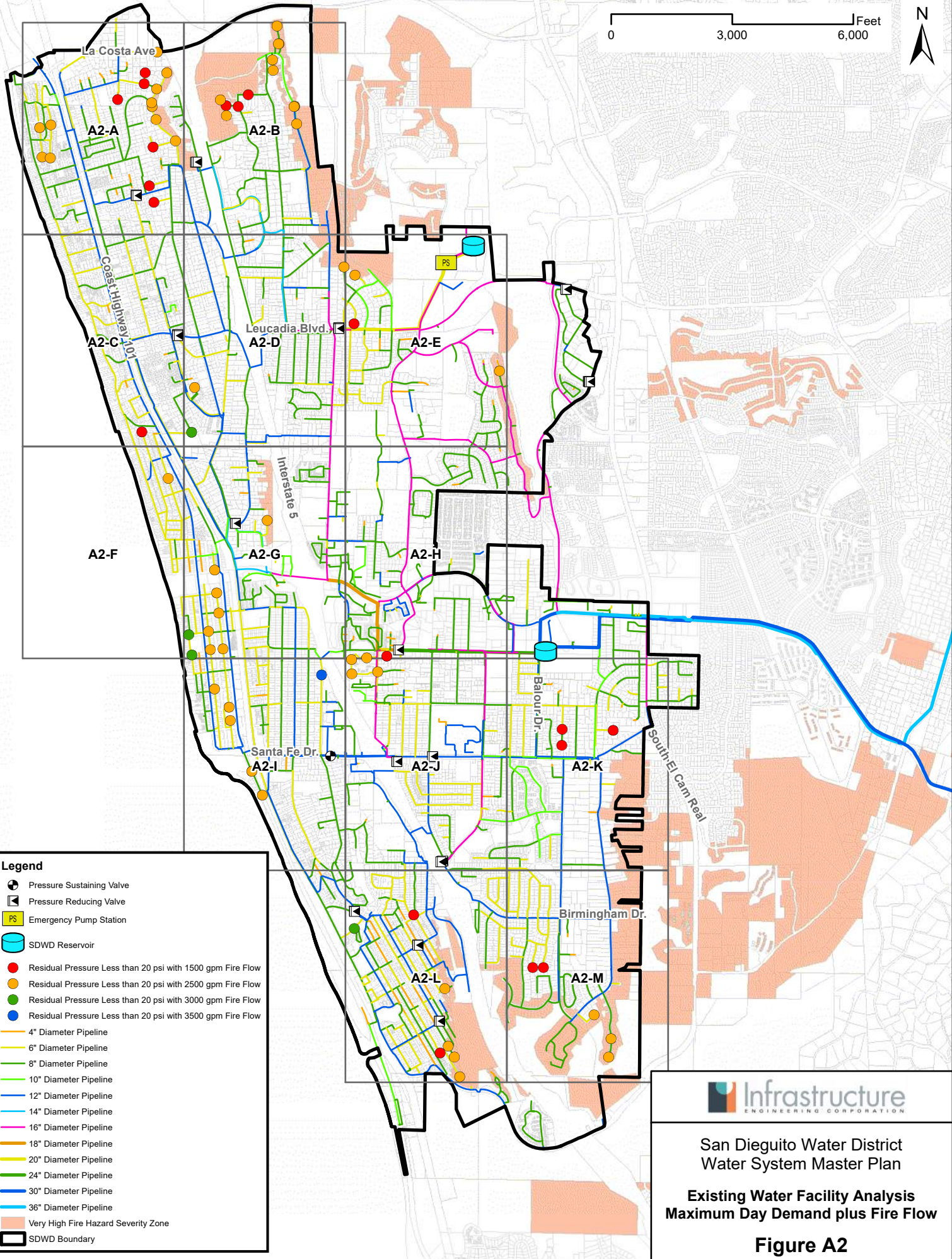
The cost to perform this condition assessment data includes evaluation of the data to recommended risk mitigation actions required (if any). This will include an evaluation of stresses placed on the pipe including pressure, external loading, and ground movement such as soil shrink swell and slope creep.

⁶ Pipe samples will be tested using Energy Dispersive X-Ray Spectroscopy (EDS) testing and petrographic analysis. These methods have proven to be the most accurate and cost-effective way to measure AC pipe condition with high degrees of accuracy. The original and remaining wall thickness measurements will be used to validate and calibrate ePulse findings.

⁷ ePulse technology works by transmitting and receiving a soundwave through the pipeline over a known distance. The speed at which the sound travels is then correlated to the average effective wall thickness.

⁸ Potholing is required to use the ePulse technology when a pipeline has limited appurtenances. Potholing will allow additional points to transmit and receive the signal. Note, while ePulse only needs a 12-inch diameter pothole, a larger hole is likely required for hot-tapping the pipe.

0 3,000 6,000 Feet



Legend

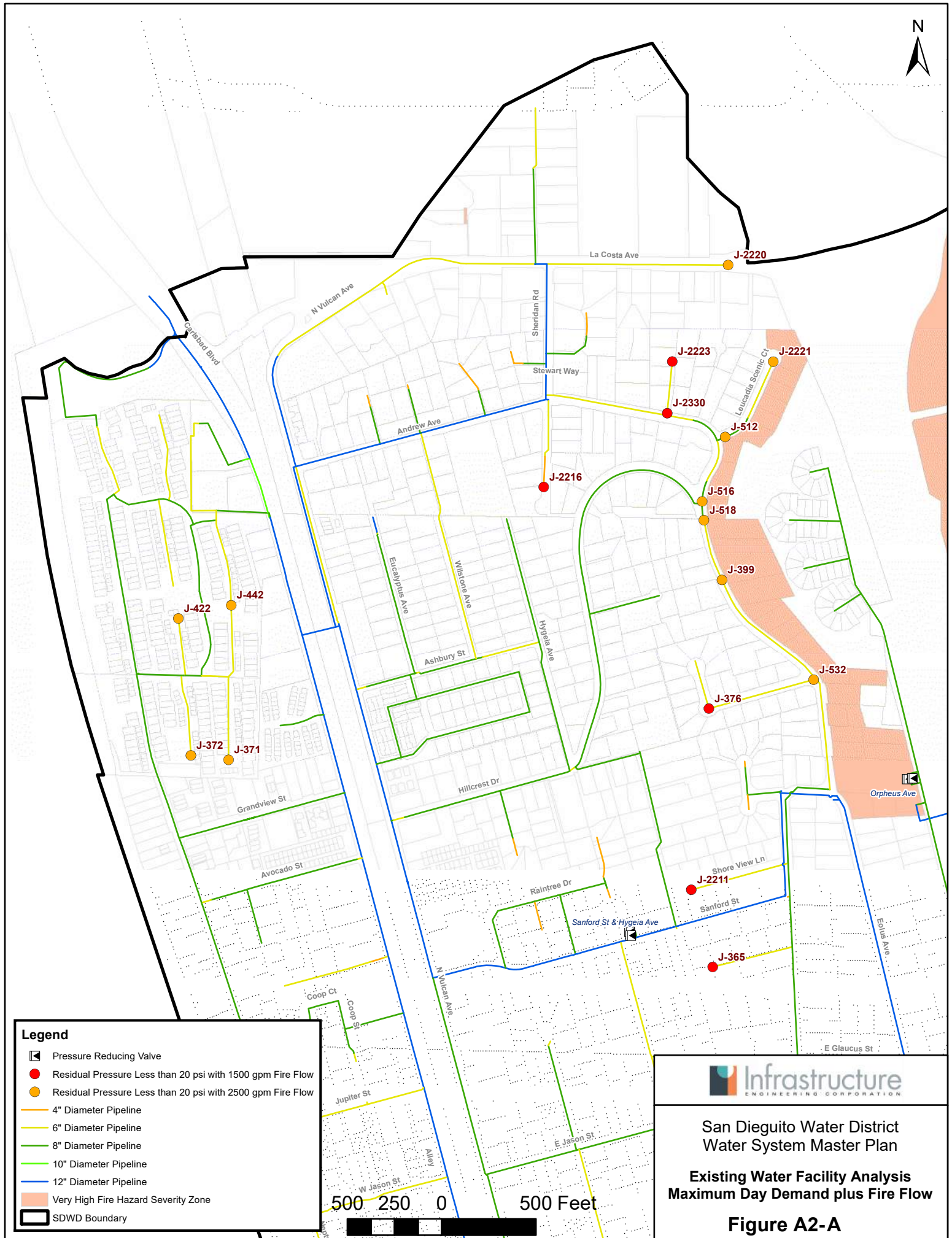
- Pressure Sustaining Valve
- Pressure Reducing Valve
- Emergency Pump Station
- SDWD Reservoir
- Residual Pressure Less than 20 psi with 1500 gpm Fire Flow
- Residual Pressure Less than 20 psi with 2500 gpm Fire Flow
- Residual Pressure Less than 20 psi with 3000 gpm Fire Flow
- Residual Pressure Less than 20 psi with 3500 gpm Fire Flow
- 4" Diameter Pipeline
- 6" Diameter Pipeline
- 8" Diameter Pipeline
- 10" Diameter Pipeline
- 12" Diameter Pipeline
- 14" Diameter Pipeline
- 16" Diameter Pipeline
- 18" Diameter Pipeline
- 20" Diameter Pipeline
- 24" Diameter Pipeline
- 30" Diameter Pipeline
- 36" Diameter Pipeline
- Very High Fire Hazard Severity Zone
- SDWD Boundary













San Diego Water District
Water System Master Plan

Existing Water Facility Analysis
Maximum Day Demand plus Fire Flow

Figure A2



Legend

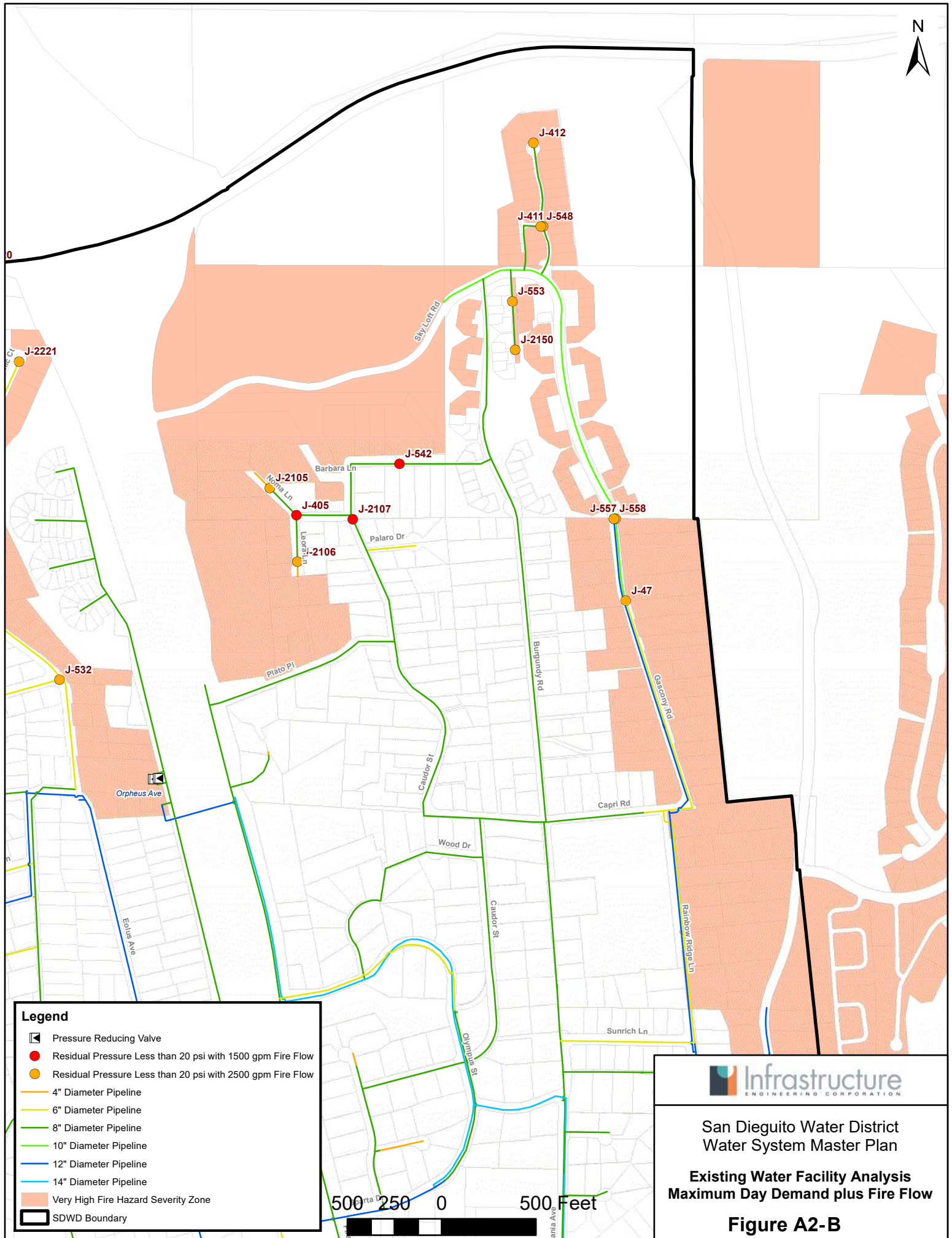
-  Pressure Reducing Valve
-  Residual Pressure Less than 20 psi with 1500 gpm Fire Flow
-  Residual Pressure Less than 20 psi with 2500 gpm Fire Flow
-  4" Diameter Pipeline
-  6" Diameter Pipeline
-  8" Diameter Pipeline
-  10" Diameter Pipeline
-  12" Diameter Pipeline
-  Very High Fire Hazard Severity Zone
-  SDWD Boundary



San Diego Water District
Water System Master Plan


Existing Water Facility Analysis
Maximum Day Demand plus Fire Flow

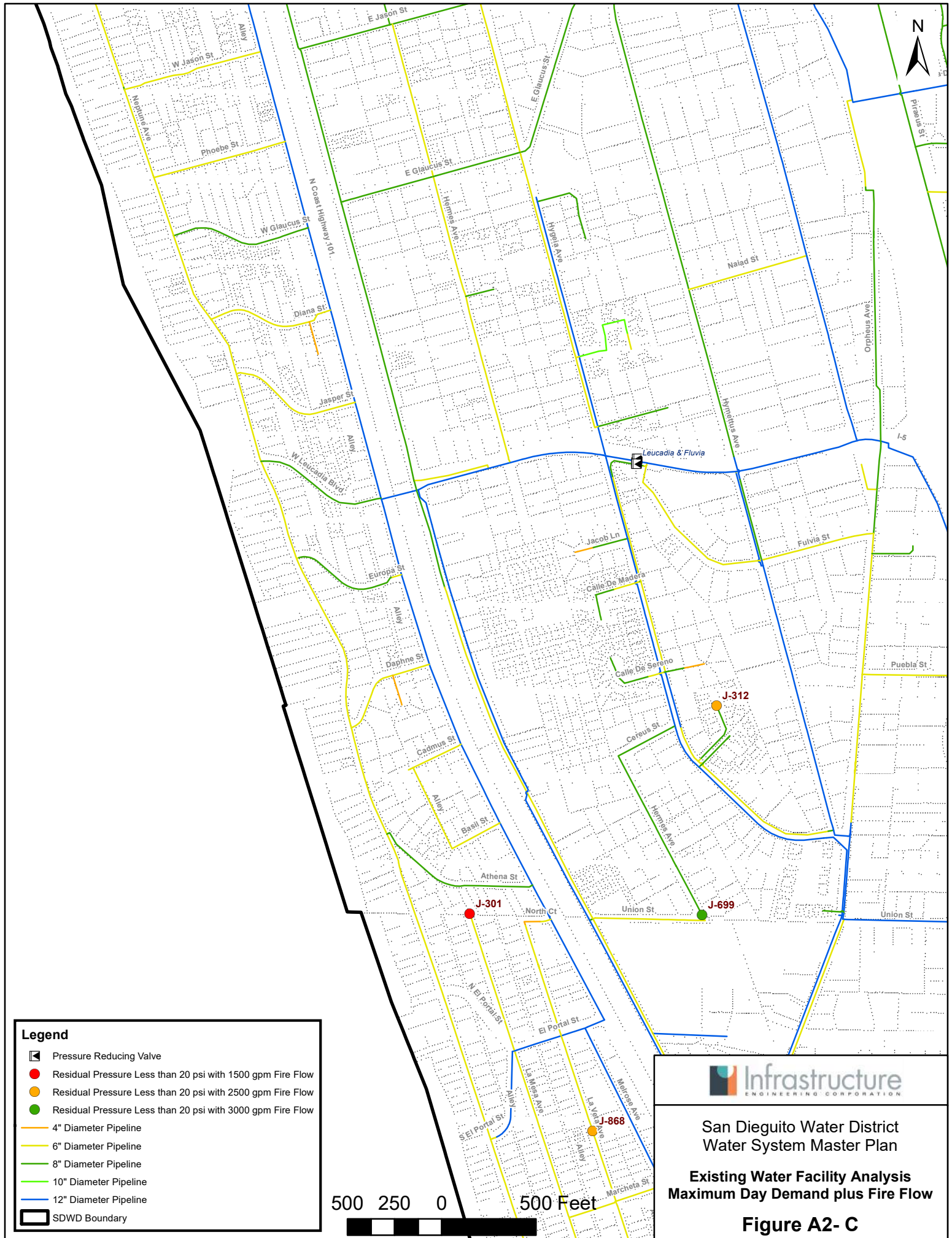
Figure A2-A













Legend

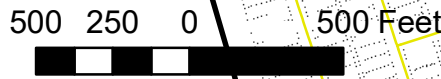
- Pressure Reducing Valve
- Residual Pressure Less than 20 psi with 1500 gpm Fire Flow
- Residual Pressure Less than 20 psi with 2500 gpm Fire Flow
- 4" Diameter Pipeline
- 6" Diameter Pipeline
- 8" Diameter Pipeline
- 10" Diameter Pipeline
- 12" Diameter Pipeline
- 14" Diameter Pipeline
- Very High Fire Hazard Severity Zone
- SDWD Boundary


San Dieguito Water District
Water System Master Plan
**Existing Water Facility Analysis
Maximum Day Demand plus Fire Flow**
Figure A2-B



Legend

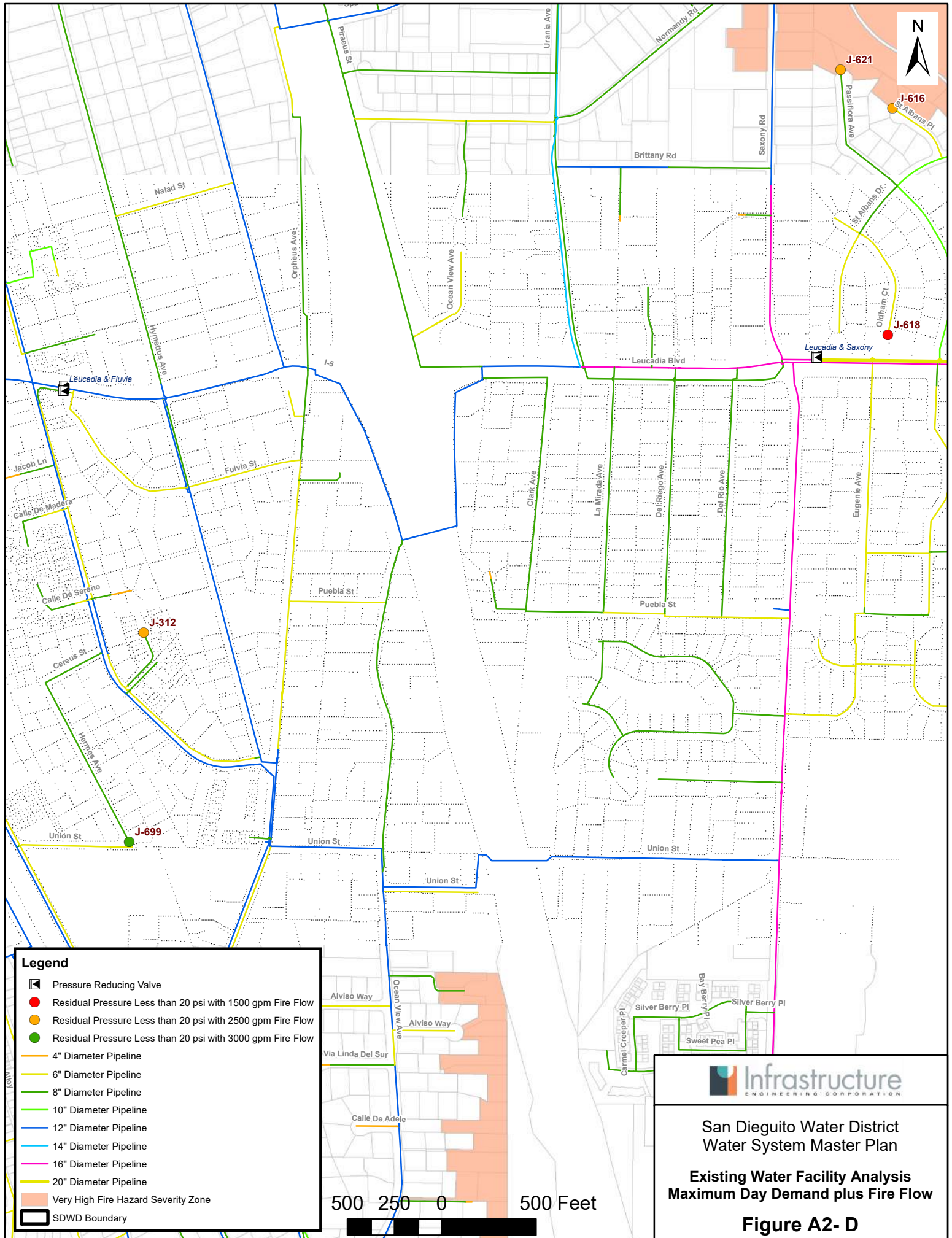
-  Pressure Reducing Valve
-  Residual Pressure Less than 20 psi with 1500 gpm Fire Flow
-  Residual Pressure Less than 20 psi with 2500 gpm Fire Flow
-  Residual Pressure Less than 20 psi with 3000 gpm Fire Flow
-  4" Diameter Pipeline
-  6" Diameter Pipeline
-  8" Diameter Pipeline
-  10" Diameter Pipeline
-  12" Diameter Pipeline
-  SDWD Boundary



San Diego Water District
Water System Master Plan

**Existing Water Facility Analysis
Maximum Day Demand plus Fire Flow**


Figure A2- C

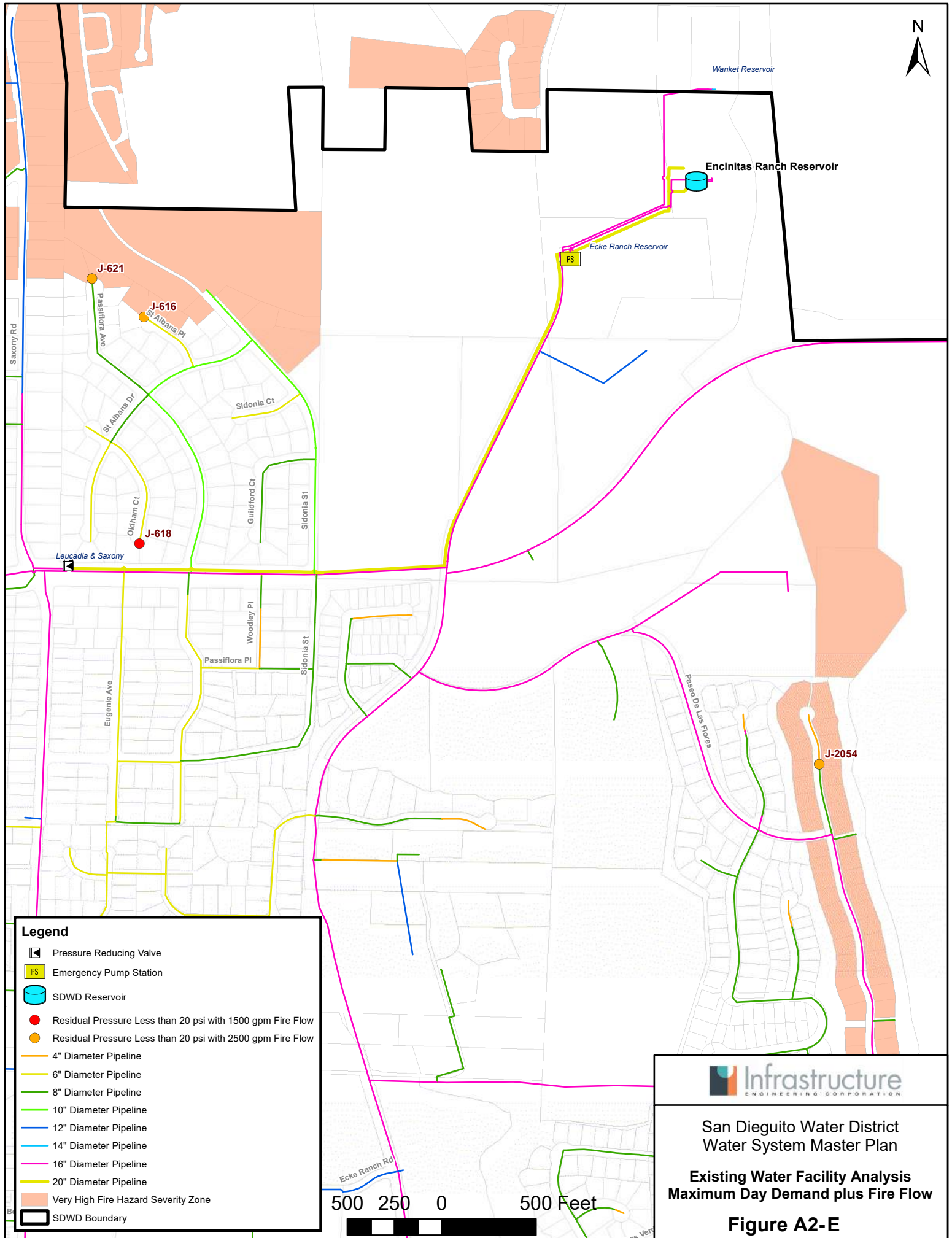


Legend
















- Pressure Reducing Valve
- Residual Pressure Less than 20 psi with 1500 gpm Fire Flow
- Residual Pressure Less than 20 psi with 2500 gpm Fire Flow
- Residual Pressure Less than 20 psi with 3000 gpm Fire Flow
- 4" Diameter Pipeline
- 6" Diameter Pipeline
- 8" Diameter Pipeline
- 10" Diameter Pipeline
- 12" Diameter Pipeline
- 14" Diameter Pipeline
- 16" Diameter Pipeline
- 20" Diameter Pipeline
- Very High Fire Hazard Severity Zone
- SDWD Boundary

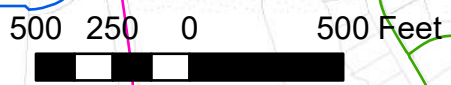



San Dieguito Water District
Water System Master Plan
Existing Water Facility Analysis
Maximum Day Demand plus Fire Flow
Figure A2- D



Legend

-  Pressure Reducing Valve
-  Emergency Pump Station
-  SDWD Reservoir
-  Residual Pressure Less than 20 psi with 1500 gpm Fire Flow
-  Residual Pressure Less than 20 psi with 2500 gpm Fire Flow
-  4" Diameter Pipeline
-  6" Diameter Pipeline
-  8" Diameter Pipeline
-  10" Diameter Pipeline
-  12" Diameter Pipeline
-  14" Diameter Pipeline
-  16" Diameter Pipeline
-  20" Diameter Pipeline
-  Very High Fire Hazard Severity Zone
-  SDWD Boundary



Infrastructure
ENGINEERING CORPORATION












San Dieguito Water District
Water System Master Plan

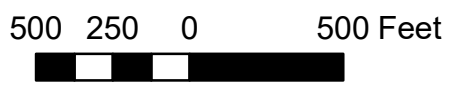
**Existing Water Facility Analysis
Maximum Day Demand plus Fire Flow**

Figure A2-E

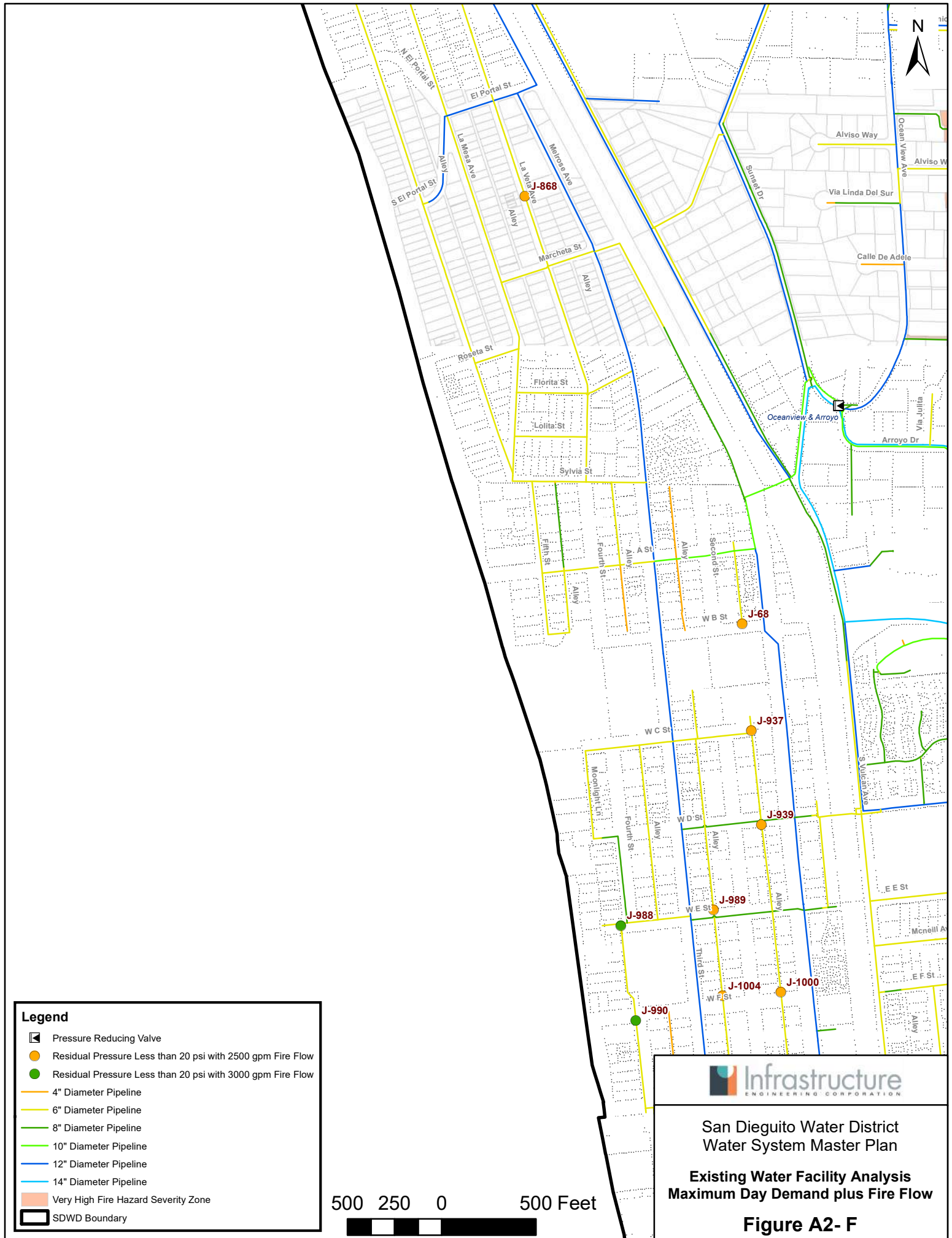


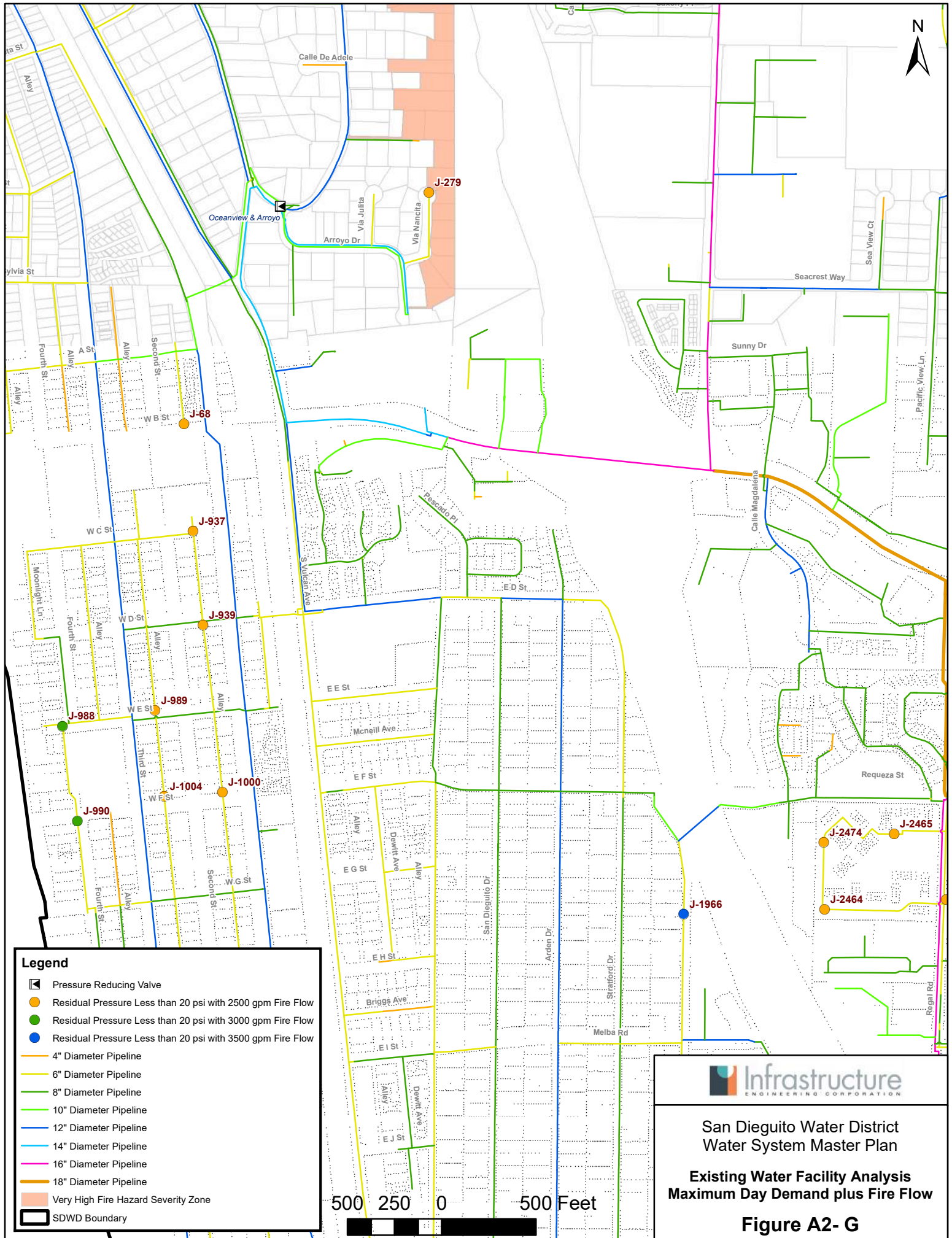
Legend

-  Pressure Reducing Valve
-  Residual Pressure Less than 20 psi with 2500 gpm Fire Flow
-  Residual Pressure Less than 20 psi with 3000 gpm Fire Flow
-  4" Diameter Pipeline
-  6" Diameter Pipeline
-  8" Diameter Pipeline
-  10" Diameter Pipeline
-  12" Diameter Pipeline
-  14" Diameter Pipeline
-  Very High Fire Hazard Severity Zone
-  SDWD Boundary




San Dieguito Water District
Water System Master Plan
Existing Water Facility Analysis
Maximum Day Demand plus Fire Flow
Figure A2- F




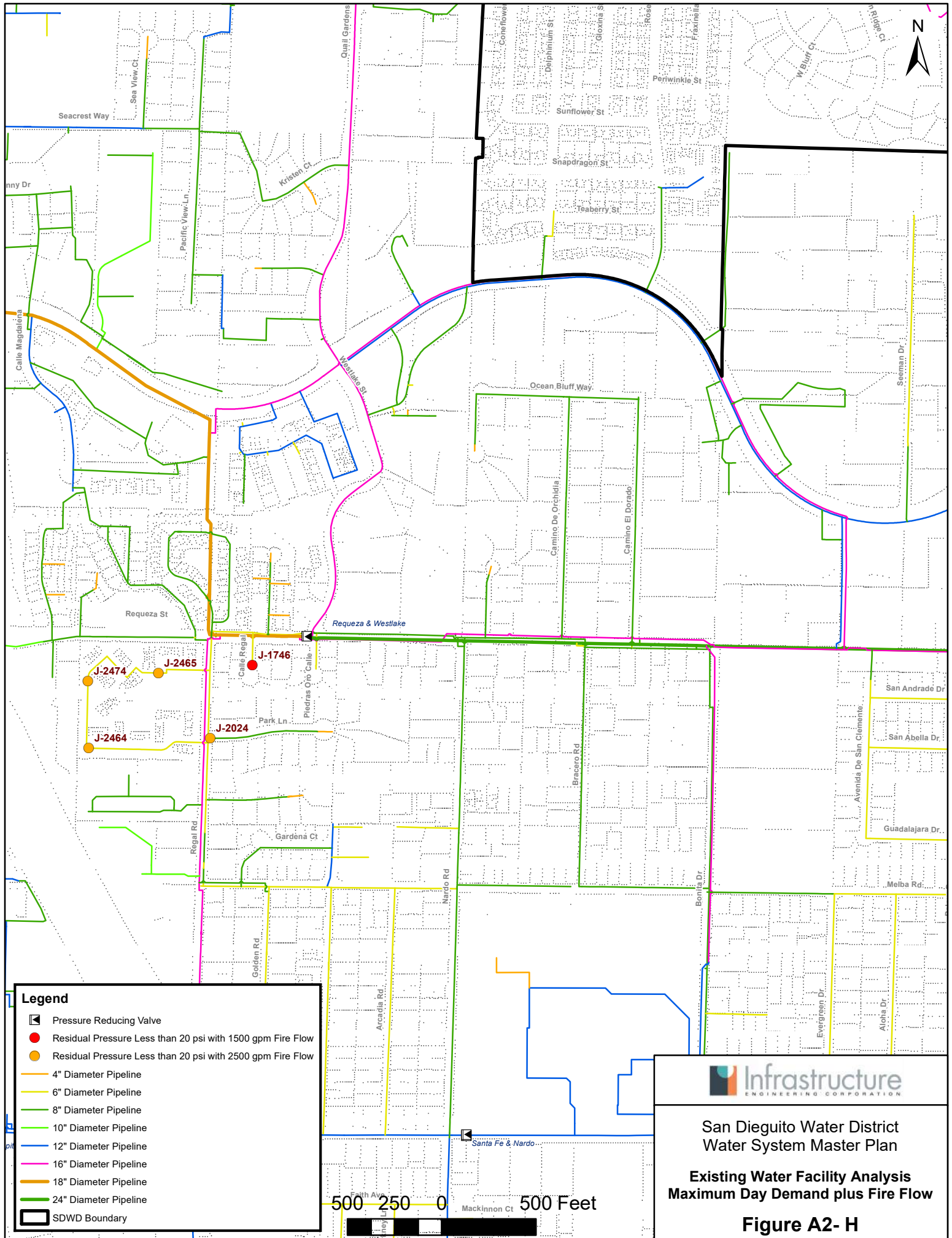


Legend

- Pressure Reducing Valve
- Residual Pressure Less than 20 psi with 2500 gpm Fire Flow
- Residual Pressure Less than 20 psi with 3000 gpm Fire Flow
- Residual Pressure Less than 20 psi with 3500 gpm Fire Flow
- 4" Diameter Pipeline
- 6" Diameter Pipeline
- 8" Diameter Pipeline
- 10" Diameter Pipeline
- 12" Diameter Pipeline
- 14" Diameter Pipeline
- 16" Diameter Pipeline
- 18" Diameter Pipeline
- Very High Fire Hazard Severity Zone
- SDWD Boundary




San Dieguito Water District
Water System Master Plan
Existing Water Facility Analysis
Maximum Day Demand plus Fire Flow
Figure A2- G



Legend

- Pressure Reducing Valve
- Residual Pressure Less than 20 psi with 1500 gpm Fire Flow
- Residual Pressure Less than 20 psi with 2500 gpm Fire Flow
- 4" Diameter Pipeline
- 6" Diameter Pipeline
- 8" Diameter Pipeline
- 10" Diameter Pipeline
- 12" Diameter Pipeline
- 16" Diameter Pipeline
- 18" Diameter Pipeline
- 24" Diameter Pipeline
- SDWD Boundary

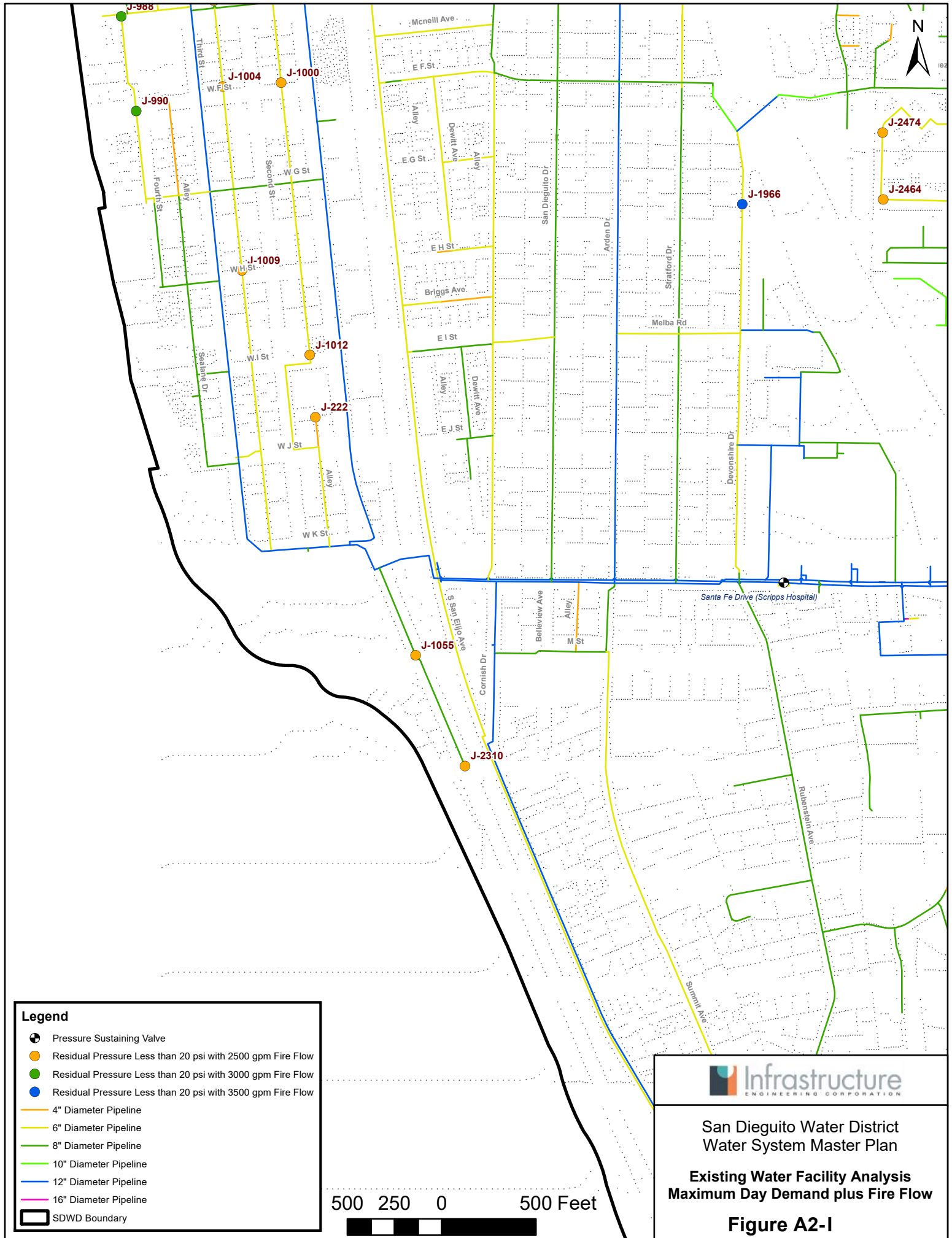


Infrastructure ENGINEERING CORPORATION

San Dieguito Water District
Water System Master Plan

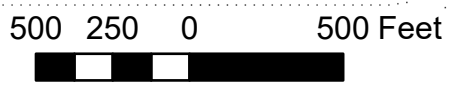
Existing Water Facility Analysis
Maximum Day Demand plus Fire Flow

Figure A2- H



Legend

- Pressure Sustaining Valve
- Residual Pressure Less than 20 psi with 2500 gpm Fire Flow
- Residual Pressure Less than 20 psi with 3000 gpm Fire Flow
- Residual Pressure Less than 20 psi with 3500 gpm Fire Flow
- 4" Diameter Pipeline
- 6" Diameter Pipeline
- 8" Diameter Pipeline
- 10" Diameter Pipeline
- 12" Diameter Pipeline
- 16" Diameter Pipeline
- SDWD Boundary

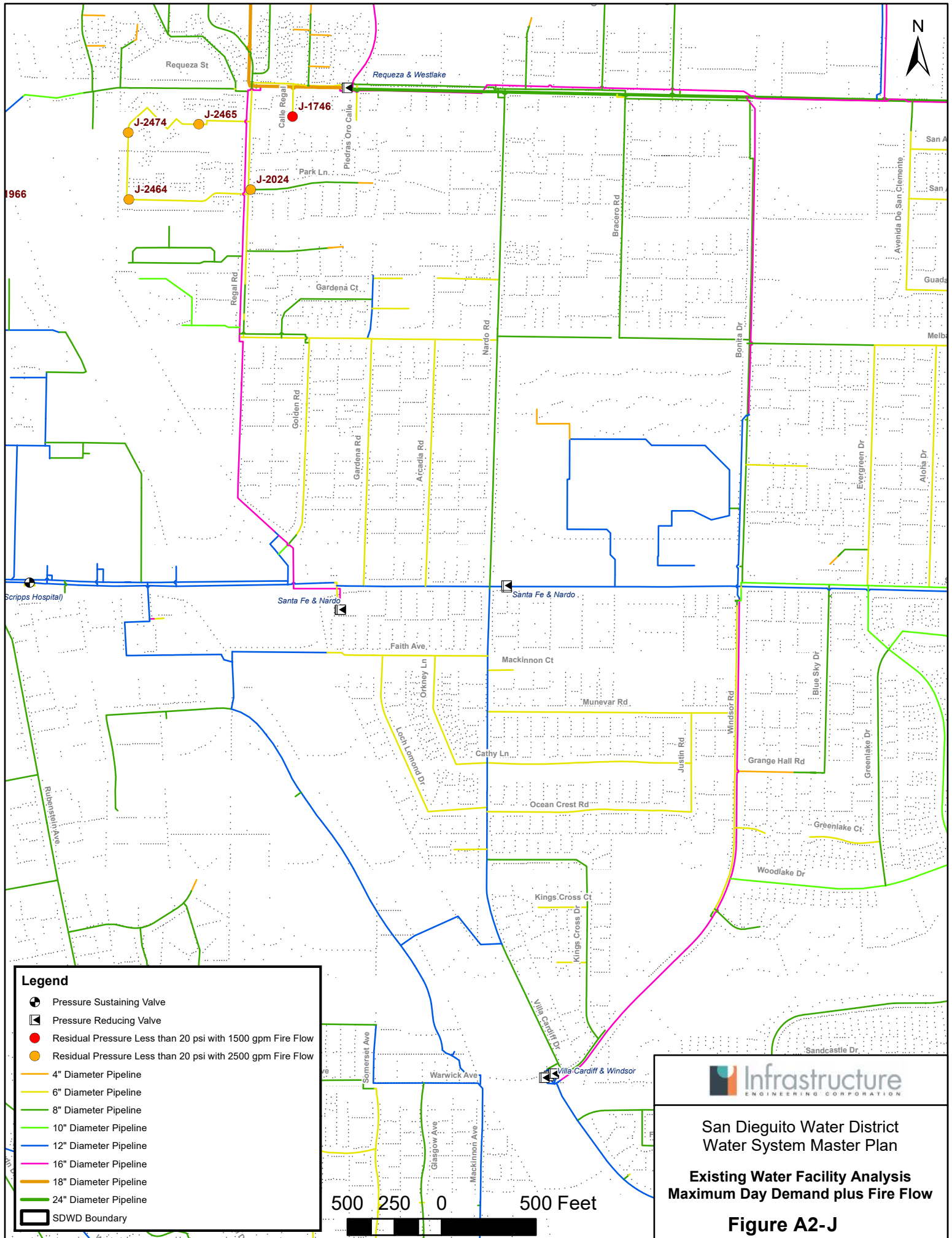


Infrastructure
ENGINEERING CORPORATION

San Diego Water District
Water System Master Plan

Existing Water Facility Analysis
Maximum Day Demand plus Fire Flow

Figure A2-I

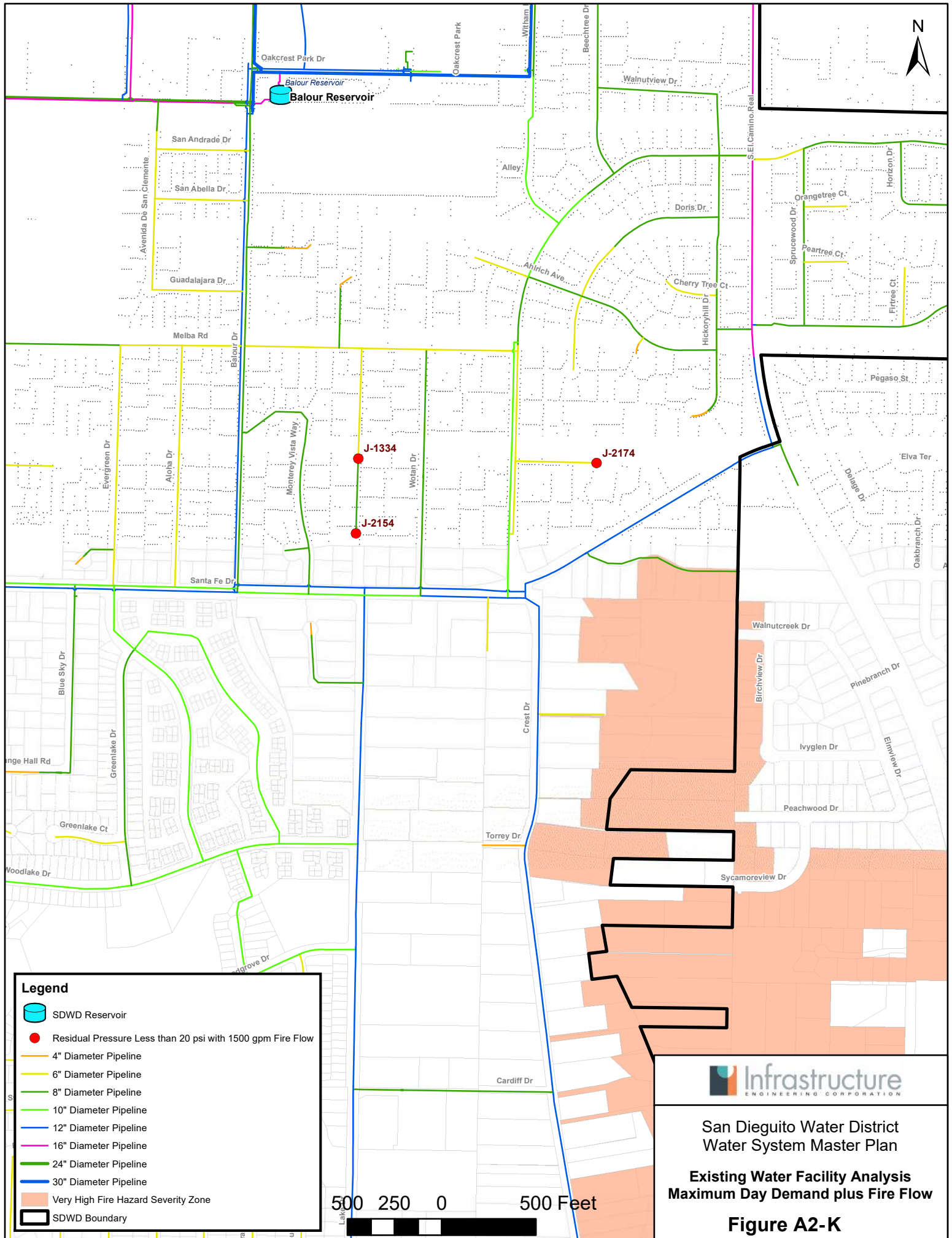


Legend

- Pressure Sustaining Valve
- Pressure Reducing Valve
- Residual Pressure Less than 20 psi with 1500 gpm Fire Flow
- Residual Pressure Less than 20 psi with 2500 gpm Fire Flow
- 4" Diameter Pipeline
- 6" Diameter Pipeline
- 8" Diameter Pipeline
- 10" Diameter Pipeline
- 12" Diameter Pipeline
- 16" Diameter Pipeline
- 18" Diameter Pipeline
- 24" Diameter Pipeline
- SDWD Boundary




San Dieguito Water District
Water System Master Plan
Existing Water Facility Analysis
Maximum Day Demand plus Fire Flow
Figure A2-J















Balour Reservoir

J-1334

J-2154

J-2174

Legend

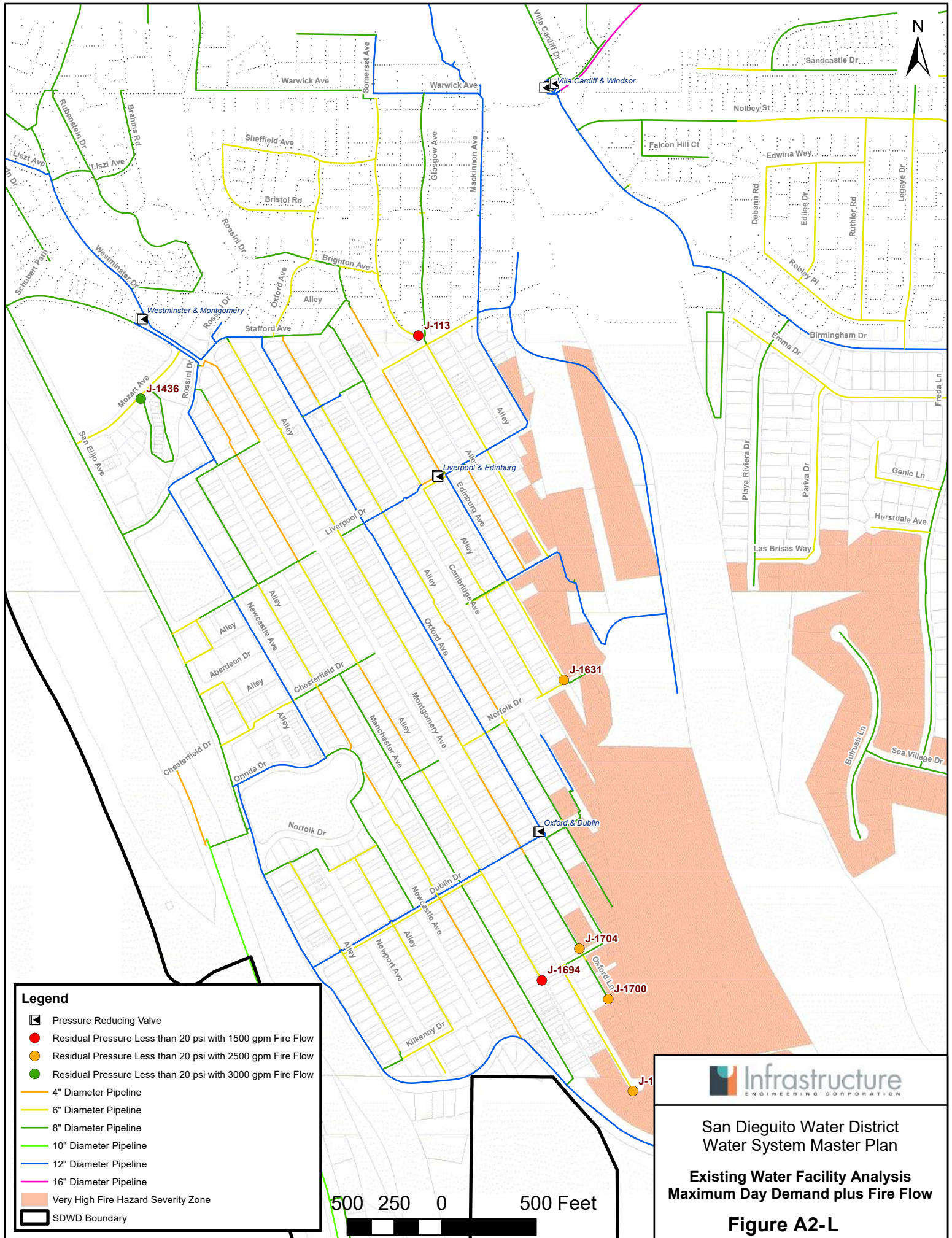
-  SDWD Reservoir
-  Residual Pressure Less than 20 psi with 1500 gpm Fire Flow
-  4" Diameter Pipeline
-  6" Diameter Pipeline
-  8" Diameter Pipeline
-  10" Diameter Pipeline
-  12" Diameter Pipeline
-  16" Diameter Pipeline
-  24" Diameter Pipeline
-  30" Diameter Pipeline
-  Very High Fire Hazard Severity Zone
-  SDWD Boundary















San Dieguito Water District
Water System Master Plan

Existing Water Facility Analysis
Maximum Day Demand plus Fire Flow

Figure A2-K



Legend

-  Pressure Reducing Valve
-  Residual Pressure Less than 20 psi with 1500 gpm Fire Flow
-  Residual Pressure Less than 20 psi with 2500 gpm Fire Flow
-  Residual Pressure Less than 20 psi with 3000 gpm Fire Flow
-  4" Diameter Pipeline
-  6" Diameter Pipeline
-  8" Diameter Pipeline
-  10" Diameter Pipeline
-  12" Diameter Pipeline
-  16" Diameter Pipeline
-  Very High Fire Hazard Severity Zone
-  SDWD Boundary



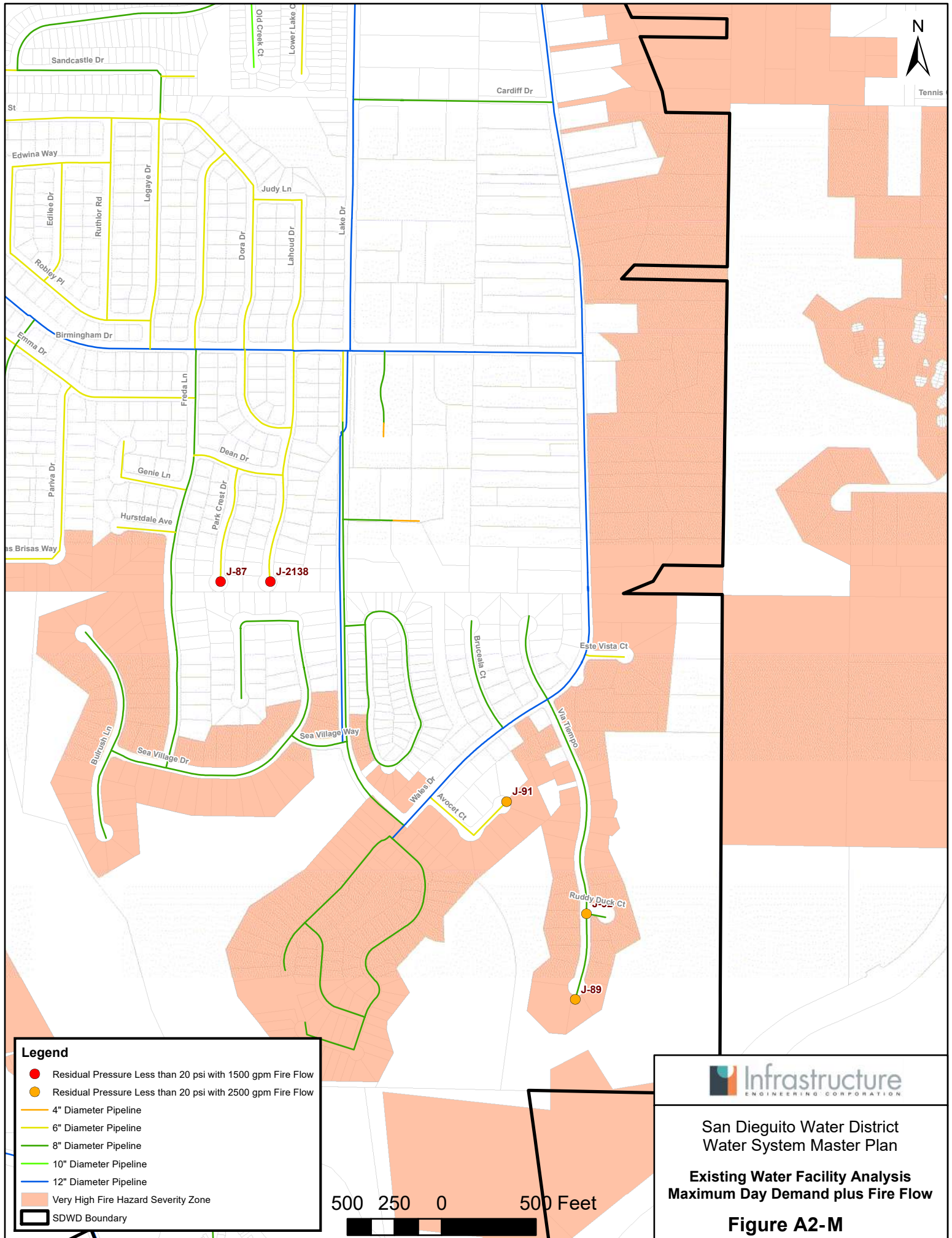
San Dieguito Water District
 Water System Master Plan

**Existing Water Facility Analysis
 Maximum Day Demand plus Fire Flow**

Figure A2-L




Tennis



Legend

- Residual Pressure Less than 20 psi with 1500 gpm Fire Flow
- Residual Pressure Less than 20 psi with 2500 gpm Fire Flow
- 4" Diameter Pipeline
- 6" Diameter Pipeline
- 8" Diameter Pipeline
- 10" Diameter Pipeline
- 12" Diameter Pipeline
- Very High Fire Hazard Severity Zone
- SDWD Boundary





San Dieguito Water District
Water System Master Plan

Existing Water Facility Analysis
Maximum Day Demand plus Fire Flow

Figure A2-M